

07.2014 EvoBus GmbH

Not to be reprinted, reproduced or translated in any form without prior permission.

Address for orders:

EvoBus GmbH
Service Documentation
D-89231 Neu-Ulm

Printed in Germany

Order no.: A 628 584 37 96

Introduction

The user information supplied with each bus is only intended for use by those persons who are qualified to operate the bus. The user information is split into the following parts:

- The Driver's Operating Instructions are intended to answer all important questions concerning operation of the bus in a concise and clearly understandable manner.
- More detailed and complete information, as well as further information relevant to safety, can be found in the Operating Instructions.
- The Maintenance Record serves as a guide to the technical care of the bus. It contains all the information on maintenance intervals and maintenance tasks as well as pages for confirming that the maintenance work has been carried out.

Please make sure that you read the "Safety" section before you use the vehicle for the first time. Before the bus is driven, please make sure that you have read and understood the contents of these Operating Instructions.

Items of optional equipment are also described, if their operation needs explanation. The bus delivered to you has been customised in accordance with your order, therefore some descriptions and diagrams may differ from the equipment on your bus.

The Driver's Operating Instructions, the Operating Instructions and Maintenance Record are important documents and must always be carried in the bus.

Our buses are the subject of ongoing development. You are therefore asked to appreciate that we reserve the right to make modifications to the design, equipment and technical features. For these reasons, no claims can be made based upon the contents of this user information.

Environmental protection:

The declared policy of EvoBus GmbH is one of integrated environmental protection. This policy starts at the root causes and encompasses in its management decisions all the consequences for the environment which could arise from production processes or the products themselves.

The objectives are for the natural resources which form the basis of our existence on this planet to be used sparingly and in a manner which takes the requirements of both nature and humanity into account.

You can also help the environment by operating the bus in an environmentally-friendly manner. Fuel consumption and wear in the drive train (engine, clutch, transmission, axles, brakes, tyres) are extremely dependent on your driving style.

We hope you enjoy driving your bus.

EvoBus GmbH

Mercedes-Benz Omnibusse

Vehicle identification	1	Towing with a tow bar (articulated buses)	24	Disabling retarder activation by brake pedal (option)	39
Safety	3	Towing with the front axle raised (rigid and articulated buses)	25	Retarder direct (customer specification)	40
Fire-prevention measures	4	Front towing coupling	26	Refuelling (diesel fuel)	41
General safety information	5	Rear towing coupling (option)	27	Service products	43
Operation of auxiliary heating	9	Brake system safety precautions	28	AdBlue® service product	43
General	11	Charging point for external compressed-air source	29	Winter operation with diesel fuels for buses with fuel-lubricated injection systems	45
Preparation for the journey - daily tasks	12	Braking and stopping	29	Low-temperature characteristics of diesel fuels	45
Preparation for the journey - weekly tasks	13	Brakes with anti-locking protection	30	Diesel fuels available by region	46
General bus care and maintenance	14	Operating pressure	30	Replacing the fuel filter	46
Care and cleaning	14	Operating/malfunction displays: brake system	31	Addition of flow improvers	46
Operation	15	Electronic Stability Program (ESP) (option) - (system description)	33	Measures required in the event of pre-existing paraffin separation	47
Running-in guideline	19	Electronic Stability Program (ESP) function description	34	Opening/closing the fuel filler cap	47
Starting the engine	19	Deactivating the Electronic Stability Program (ESP)	36	BlueTec® exhaust gas cleaning system	49
Driving	22	Activating and deactivating acceleration skid control (ASR)	37	AdBlue® service product	50
Stopping the engine	23	Operating/malfunction displays: ABS/ASR	38	AdBlue® supply tank installation location	52
Towing with a tow bar (rigid buses)	23			Filling with AdBlue®	52
				Diesel particulate filter	54

Table of contents

Diesel particulate filter regeneration	56	Tilting the seat row on the transmission cover	78	Tachograph approval seal	106
Starting regeneration of the diesel particulate filter manually (parked regeneration)	58	Care and cleaning of covers and upholstery	79	Location of emergency equipment	106
Operating/malfunction displays: fuel system/exhaust gas cleaning system	60	Care/cleaning of fabric covers	79	Windscreen washer fluid reservoir installation location	108
Operating 230/400 V systems (option)	62	Malfunction displays: Yellow warning level - description	81		
Function description: accident data recorder (ADR) (option)	62	Malfunction display: Red warning level	82		
Anti-jackknifing protection during forward travel	64			Driver's area controls	109
Anti-jackknifing protection during reverse travel	65	At a glance	85	Rotary light switch	112
Passenger stop request	66	Overview of vehicle key	86	Left steering column switch: Light and signal functions	113
Ramp request	67	Driver's area overview	88	Left steering column switch: Wiper and wash functions	113
Safety instructions for the operation of mechanically folding/electric ramps (options)	68	Switches on the left section of the instrument panel	89	Combination switch for retarder and cruise control (option)	114
Folding the ramp in/out	69	Switches on the right section of the instrument panel	91	Ignition starter switch	118
Retracting/extending the electric ramp (option)	71	Driver's area side compartment	94	Parking brake	118
Opening the hinged window	75	Instrument cluster	98	Master safety switch (emergency-off switch)	119
Care and cleaning	76	MTCO tachograph	102	Overview of steering wheel buttons and display screen	122
Tilting a rear seat	77	DTCO tachograph	104	Display screen	124
		Tachograph	105	Display screen (description)	125
				Permanent displays	126
				Trailer turn signals	127
				Overview of main menus and submenus	128

Menu structure	129	Left-hand steering wheel buttons	160	Driver's seat/passenger seats	179
Display screen menu control logic	136	Vehicle manoeuvrability with the air suspension depressurised	161	Important notes on the driver's seat	180
Event notifications	138	Lowering/raising the bus on the boarding side	162	Grammer MSG 90.5 driver's seat control elements	182
Overview of the operating, function and malfunction display screen	140	Raising the bus above normal level	164	Using the driver's seat belt	184
Instrument cluster "button assignment"	146	Activating/deactivating the pull-away aid	166	Transmission shift systems	185
Resetting the trip meter	147	Applying the parking brake	167	Automatic transmission - general	186
Trip computer data manual reset	148	Releasing the parking brake	168	Tilting the seat row on the transmission cover	187
HOME button	149	Emergency braking in the event of failure of both brake circuits	169	Selector positions of the 3-pushbutton switch panel	188
Menu button	150	Activating/deactivating the bus stop brake	170	Selector positions of the 6-pushbutton switch panel	190
DIAG button (on-board diagnostics)	150	Drive-off lock	171	Heating/ventilation/air-conditioning	193
SET button	151	Important information on the steering system	172	Safety instructions for the air-conditioning system	195
Setting the language	152	Adjusting the steering wheel	173	Operating instructions for the air-conditioning system	195
Adjusting the volume of the turn signal buzzer	154	Turning the steering wheel when the bus is stationary	174		
Adjusting the display brightness (daytime brightness)	155	Opening/closing the driver's window	175		
Adjusting the display brightness (night brightness)	156	Switching the mirror and window heating on and off	176		
Right-hand steering wheel buttons	158				

Table of contents

Heating/ventilation/air-conditioning control panel - driver's area	196	Passenger-compartment temperature - changing the base value	209	Locking/unlocking door leaves from the outside (option)	235
Heating/ventilation/air-conditioning control panel - complete bus	198	Opening/closing the roof hatches	212	Locking door 1 with the key (option)	236
Driver's area - setting the air distribution/demisting the wind-screen	199	Fans on/off	215	Locking/unlocking the door leaves from the inside	236
Driver's area - adjusting the temperature	200	Switching the fans on/off (bus with air-conditioning system)	216	Opening/closing the doors from the inside	237
Driver's area - adjusting the blower speed	201	Auxiliary heating preset timer (option)	218	Opening/closing automatic doors from the inside	238
Driver's area - cooling	202	Operating the auxiliary heater (option)	219	Opening/closing automatic doors from the outside	240
Additional driver's area ventilation (option)	203	Programming the auxiliary heating preset times	222	Opening/closing automatic doors	242
Switching air-recirculation mode on and off	203			Switching between automatic and manual door operation	245
Passenger compartment - switching automatic temperature regulation on and off - code HH2/HK1	204	Opening/locking	227	Teaching in the doors in the closing and opening directions	247
Passenger compartment - switching automatic temperature regulation on and off	205	Protection against entrapment in the door opening direction	228	Pushchair stop request	250
Switching the auxiliary heating on and off	206	Protection against entrapment in the door closing direction	228		
Switching the reheat function on and off	208	Emergency operation - doors	230	Practical advice	253
		Forced door closure in an emergency	232	Note on maintenance work and underbody cleaning	256
		Opening/closing door 1 from the outside	234	Safety precautions for work carried out in the engine compartment	256
				Oil level information (option)	257

Checking the engine oil level, topping up if necessary.	259	Jacking points, rear	273	Jump-starting where vehicle batteries are mounted side by side	284
Operating safety and roadworthiness	260	Emergency release of the drive-off lock	274	Jump-starting buses equipped with a battery charging socket	286
Tyre pressure	261	Electrical system safety precautions	275	Opening the emergency exit in the roof	287
On-screen tyre pressure monitor (option)	261	General safety precautions for batteries	276	Folding out and folding in headlamps or bumper corner pieces . . .	289
Tyre tread	263	Safety precautions for handling batteries	276		
Tyre condition	263	Battery maintenance	277		
Tyre age	263	Testing the battery	277	Technical data	291
Invisible tyre damage	264	Recharging the batteries	278	Vehicle data	292
Tyre load capacity, top speed of tyres and types of tyres	264	Working on the electrical system and electrical fuses	278		
Retreaded tyres	265	Measures required for the prevention of damage to buses or components during electric welding work	279		
Cleaning the tyres	265	Switching the on-board power supply on/off	280		
Retightening the wheel nuts	265	Battery isolating switch (with switch-off authorisation LED)	281		
Wheel nut tightening torques	266	Switching the on-board power supply on/off (articulated bus) . . .	282		
Snow chains	266	Switching off the on-board power supply at the master safety switch	283		
Tyre pressures table	268			Index	294
Safety measures to be taken in the event of a flat tyre or a wheel change	270				
Jacking points	270				
Jacking points, front	272				
Jacking points, centre (articulated buses only)	272				



M00.01-0006-71

The identification plate is located in the front doorway.



Note:

Precise vehicle identification is a prerequisite to exact and correct assignment of “vehicle data”.

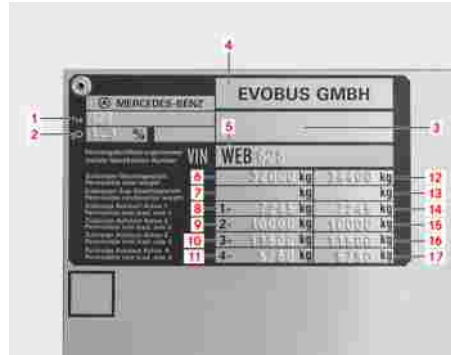

M00.01-0011-81

No.	Designation	Value
-----	-------------	-------

1	Vehicle model	
2	Headlamp basic setting	
3	EC type-approval number	
4	Vehicle manufacturer	
5	Vehicle Identification Number (VIN)	

No.	Designation	Value
-----	-------------	-------

6	Permissible gross weight (country-specific)	
7	Permissible gross combination weight (country-specific)	
8	Permissible front axle load (country-specific)	
9	Permissible axle load for 2nd axle (country-specific)	
10	Permissible axle load for 3rd axle (country-specific)	
11	Permissible axle load for 4th axle (country-specific)	
12	Permissible technical gross weight	

No.	Designation	Value
13	Permissible technical gross combination weight	
14	Permissible technical axle load for front axle	
15	Permissible technical axle load for 2nd axle	
16	Permissible technical axle load for 3rd axle	
17	Permissible technical axle load for 4th axle	



M00.00-0614-71

Vehicle identification number (1) is additionally marked on the skeleton at the front of the bus. It is accessible via the bumper corner piece on the right-hand side.

Fire-prevention measures	4
General safety information	5
Operation of auxiliary heating	9

Fire-prevention measures

Fire-prevention measures

Pre-drive measures

- Check tyre pressures (daily visual check/weekly measurement)
- Check that twin tyres are spaced sufficiently apart

On-road measures

- Monitor coolant temperature

Post-drive measures

- Inform a mechanic/next driver about malfunction, if applicable

Parking the vehicle

- Switch the battery isolating switch to OFF.



Danger.

Risk of fire and burns. There is a risk of fires and burns due to the high exhaust temperatures and the hot exhaust pipe for the auxiliary heating. For this reason, do not stop or park the bus over ignitable materials (e.g. grass) when the auxiliary heating is in operation, has recently been in operation or has been operated by the instant heating button/preset timer.



Danger.

Risk of fire and burns. Regeneration of the diesel particulate filter is associated with very high temperatures. For this reason, before regeneration is initiated manually, make sure that there are no flammable materials near the exhaust pipe and exhaust system.

General safety information

The use of symbols and their meanings

Safety precautions and other important information are highlighted by symbols.

In addition to the instructions provided herein, all generally applicable safety and accident prevention regulations must also be observed, e.g. in Germany, the rules and regulations of the institutions for statutory accident insurance and prevention.

Instructions and information printed on the packaging for components, tools and service products must also be observed.

Where information and instructions are to be observed, it is assumed that the user information is intended for persons who are suitably qualified to carry out the tasks by nature of their education, training and experience.

These persons should, at the same time, be able to identify risks that may arise in the undertaking of their tasks and take the necessary measures to avoid them.

Meaning of symbols:



Note:

Notes about important additional information



Caution:

Warning notes about damage that may occur in the event of non-compliance



Danger.

Warning notes for risks to persons



Environmental protection

Notes about environmental protection measures

▷ Reference to more detailed and additional user information

Notes on vehicle safety

We recommend that you:

- Use only genuine parts that are OMNIplus quality tested and conversion parts and accessories that have been expressly approved by EvoBus for the bus model concerned in order to rule out the possibility of jeopardising road safety and invalidating the warranty and general operating permit. These parts have been specially tested for their safety, reliability and suitability.

You can obtain further information from any OMNIplus Service Partner.

Operating safety

Important information:

- Any work or modifications that have been carried out incorrectly on the bus may result in malfunctions.
- Tampering with electronic components and their software may cause malfunctions. As electronic components are networked, these malfunc-

General safety information

tions may also cause other, indirectly related systems to malfunction. These malfunctions may jeopardise the operating safety and reliability of the bus.

- Retrofitted electrical or electronic devices must possess type-approval complying with Directive 95/54/EC or ECE Directive 10/02.
- Materials that are fitted in the bus during the course of installation, conversion or modification work and that are subject to mandatory fire-testing requirements must satisfy the requirements of EU Directive 95/28/EC.
- Materials and components of seats and seat fixtures that are also fitted in the bus during the course of installation, conversion or modification work must satisfy the requirements of the following directives: 76/115/EEC as amended by 96/38/EC, 74/408/EEC as amended by 96/37/EC, 77/541/EEC as amended by 96/36/EC.

- At the time of purchase or installation, it must be checked that these materials and components have been certified accordingly. The use of materials or components that have not been granted the relevant certificate may result in the operating permit being invalidated.
- We recommend that you have work or modifications carried out by an OMNIplus Service Partner.

Stickers

There are various warning stickers affixed to your bus. These are intended to make you and others aware of various dangers. Therefore, do not remove any warning stickers unless it is expressly stated on the sticker that you may do so.



Danger.

If you remove warning stickers, this could result in you or other persons failing to recognise dangers. You or others could be injured as a result.

Data stored in the vehicle

A host of electronic components in your vehicle contain a data memory. These data memories store information, temporarily or permanently, relating to

- Vehicle condition
- Events
- Faults

These items of technical information generally document the state of a component, module, system or the environment. These could be, for example:

- Operating states of system components. These include fill levels, etc.
- Status messages relating to the vehicle and its individual components. These include, for example,

wheel rotation speed/driving speed, deceleration, lateral acceleration, accelerator pedal position.

- Malfunctions and defects in important system components. These include lights, brakes, etc.
- Responses and operating states of the vehicle in specific driving situations. These include, for example, triggering of an airbag, intervention of stability control systems.
- Environmental states. These include outside temperature, etc.

The data are exclusively technical in nature and can be used for

- assisting the detection and rectification of faults and defects,
- analysing vehicle functions, e.g. after an accident,
- optimising vehicle functions.

Motion profiles on driven routes cannot be generated from these data. Whenever you arrange for a particular vehicle service, these items of technical information

can be read out from the event and fault data memories.

Services include, for example:

- Repairs
- Customer service processes
- Warranty claims
- Quality assurance

This read-out is performed by employees in the ServiceNetwork (including manufacturers) with the use of special diagnostic testers. They enable you to obtain further information as and when necessary. After faults have been rectified, the information in the fault memory is cleared or continuously overwritten. During use of the vehicle, certain situations could arise in which these technical data could become personal data when combined with other information - where applicable under the direction of an independent expert.

Examples include:

- Accident logs
- Damage to the vehicle
- Witness statements

Other auxiliary functions that are contractually agreed with the customer similarly permit the outgoing communication of vehicle data from the vehicle. Example:

- FleetBoard telematics system

Operation of radio and mobile communications equipment

(e.g. telephone, two-way radio, etc.)



Danger.

Please devote your attention primarily to road and traffic conditions. Do not operate the display unit, radio or mobile communications equipment unless the traffic situation permits this to be done safely. Please bear in mind that your bus will cover a distance of 14 metres every second at a speed of only 50 km/h.

General safety information



Note:

In the Federal Republic of Germany, Section 23, Paragraph 1a of the German road traffic regulations (StVO) prohibits a vehicle driver from using a mobile phone or an on-board telephone/intercom if this use involves lifting up or holding the mobile phone or the telephone/intercom handset.



Danger.

Please observe local legal requirements governing the use of mobile phones or on-board telephones/intercoms in force in the country of vehicle operation.

Operation of mobile phones and two-way radios without an exterior aerial

We advise against making or receiving telephone calls in buses not equipped with an exterior aerial as the operation of radio transmitters, which include but are not limited to radio telephones (mobile phones), may cause inadequately

shielded equipment (cardiac pacemakers included) to malfunction.



Note:

If a mobile phone or radio system is retrofitted in the bus in a manner that does not comply with EvoBus installation specifications, the operating permit for the bus could be invalidated (EU Directive 95/54/EC).



Note:

Older peripherals (e.g. ticket-printing machines, ticket-cancelling machines, destination displays, etc.) that are still used in new buses must comply with the technical requirements of EC Directive 72/245 EEC.



Danger.

Please observe local legal requirements governing the use of mobile phones or on-board telephones/intercoms in force in the country of vehicle operation.

Washing the outside of the bus in an automatic vehicle wash

Before the bus is washed, make sure that the roof hatches, driver's window and the doors are closed. Set the heating/ventilation/air-conditioning system to air-recirculation mode (Smog button).



M88_00-0085-71

Before the bus is washed, fold right-side exterior mirror (1) inwards towards the windscreen by means of the hinge pin on the mirror arm.

After the washing process, fold the exterior mirror outwards again.

Operation of auxiliary heating

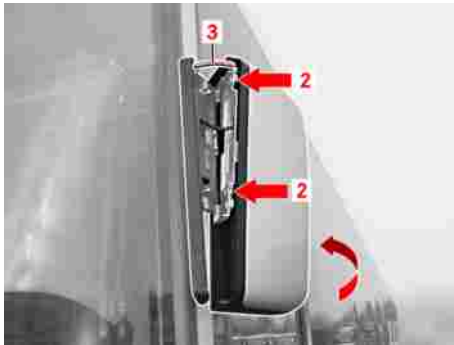

M88_00-0081-71

Disengage the left-side mirror from two retaining springs (2) by yanking the outside edge of the mirror housing to the rear. The mirror can now be pivoted up to a distance of 90 mm from the outside surface of the bus. In this position, a tensioning spring (3) prevents the mirror from swinging back inadvertently.

After the washing process, bend tensioning spring (3) slightly by pressing from the side, pivot the mirror towards the front of the bus and engage it in the retaining springs.

Before the bus is washed, remove attachment parts (e.g. roof-mounted satellite receivers, exterior aerials, etc.).

Operation of auxiliary heating

 **Danger.**

Risk of fire and burns. There is a risk of fires and burns due to the high exhaust temperatures and the hot exhaust pipe for the auxiliary heating. For this reason, do not stop or park the bus over ignitable materials (e.g. grass) when the auxiliary heating is in operation, has recently been in operation or has been operated by the immediate heating button/preset clock.

 **Danger.**

Risk of poisoning and suffocation. The auxiliary heating must not be used in enclosed spaces such as garages or workshops due to the risk of poisoning and suffocation. It must also not be used in timer or preselection mode.

Operation of auxiliary heating



Danger.

Risk of explosion. The auxiliary heating must be switched off at filling stations and fuel dispensing systems due to the risk of explosion.



Danger.

Risk of fire. The auxiliary heating must remain switched off in places where ignitable vapours or dust can accumulate (e.g. in the vicinity of filling stations, fuel, coal, sawdust and grain stores or similar).



Caution:

The heating unit must be operated for 10 minutes at least once a month (also during the warm season) when the engine is cold.

Preparation for the journey - daily tasks 12

Preparation for the journey - weekly tasks 13

General bus care and maintenance 14

Care and cleaning 14

Preparation for the journey - daily tasks

Preparation for the journey - daily tasks

- ▷ You will find instructions and notes on the windscreen washer fluid reservoir in the “At a glance” section.
- ▶ Check the windscreen washer fluid level and test the windscreen washer system and windscreen wipers.
- ▶ Check the fuel level for the engine and auxiliary heating.

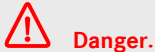

Danger.

Switch off the engine and auxiliary heating before refuelling.

- ▶ Check the AdBlue® additive level in the BlueTec® exhaust gas cleaning system.
- ▶ Check the electrical system, paying particular attention to the headlamps, turn signals, tail lamps, brake lamps and licence plate lamps.



Note:

Under certain weather and operating conditions, moisture may form on the inside of the headlamps and other lights when the bus is stationary. This does not indicate a fault or defect. The ventilation openings in the headlamps allow this moisture to evaporate after the bus has been driven for a short time.

- ▶ Check the service covers for secure locking.
- ▶ Check the emergency exits.
- ▶ Insert the tachograph recording disc or the driver card.



Note:

If the indicator lamp in the tachograph is lit, no disc or driver card has been inserted.

- ▶ Check that the emergency equipment is accessible and complete, e.g. first-aid kit, fire extinguisher, warning triangle, emergency hammer for side windows, jack.

- ▶ Check the adjustment of the interior and exterior rear-view mirrors, clean the mirrors, check the mirror heating for correct function.
- ▶ Check tyre pressures and tyre condition. Check wheel nuts and wheel trim discs for firm seating.

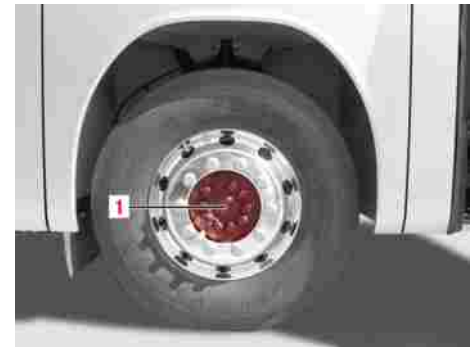

M40_00-0115-71

- ▶ Check wheel hubs (1) on all wheels for leaks inside and out (visual check).

Preparation for the journey - weekly tasks

**Note:**

If the wheel hubs are leaking, there may be grease or oil residue on the tyres themselves or deposits on the parking area on which the bus is standing. Consult an OMNIplus Service Partner in the event of a leak.

Preparation for the journey - weekly tasks

- ▷ Oil level in the hydraulic steering system, belt tension, drain fuel filter, refer to maintenance information.
- ▶ Check the oil level in the hydraulic steering system.

**Caution:**

If the oil level is low, have the steering system checked at an authorised specialist workshop.

- ▶ Check the belt tension of all belt drives.
- ▶ Carry out a visual check to ensure there are no leaks in the engine, transmission, driven axle, steering or the cooling and heating systems.

- ▶ Check the acid level in the starter batteries.

**Danger.**

Observe the safety precautions in the “Practical advice” section.

General bus care and maintenance

General bus care and maintenance

- ▶ Carry out the work specified in the Maintenance Record.



Danger.

Risk of accident. Maintenance tasks must be carried out on the chassis and drive train at regular intervals to maintain the operating safety and roadworthiness of the bus. The time intervals and the scope of the required tasks are specified in the Maintenance Record.



Caution:

It is strongly recommended that the specified maintenance intervals be observed.



Note:

Warranty claims may be rejected if the periodic maintenance tasks have not been carried out at the specified distances (odometer reading) or times. Have confirmation of the completed work recorded in the Maintenance Record by an OMNIplus Service Partner.

Care and cleaning

- ▷ You will find further instructions and notes on caring for and cleaning your bus in the “Operation” section.



Note:

The following stipulations for exterior cleaning must be observed: Use a sufficient amount of fresh water. Dry rubbing between washing brushes and the vehicle must not be allowed to occur. Preclean heavily soiled components. The polishing of lighting equipment with commercially available care products is not permitted. The use of polyethylene fibres as a brush material is not permitted. Recommendation: Use brushes made with textile fibres or foam.

Running-in guideline 19

Starting the engine 19

Driving 22

Stopping the engine 23

Towing with a tow bar (rigid buses) 23

Towing with a tow bar (articulated buses) 24

Towing with the front axle raised (rigid and articulated buses) 25

Front towing coupling 26

Rear towing coupling (option) 27

Brake system safety precautions 28

Charging point for external compressed-air source 29

Braking and stopping 29

Brakes with anti-locking protection 30

Operating pressure 30

Operating/malfunction displays: brake system 31

Electronic Stability Program (ESP) (option) - (system description) 33

Table of contents

Electronic Stability Program (ESP) function description	34
Deactivating the Electronic Stability Program (ESP)	36
Activating and deactivating acceleration skid control (ASR)	37
Operating/malfunction displays: ABS/ASR	38
Disabling retarder activation by brake pedal (option)	39
Retarder direct (customer specification)	40
Refuelling (diesel fuel)	41
Service products	43
AdBlue® service product	43
Winter operation with diesel fuels for buses with fuel-lubricated injection systems	45
Low-temperature characteristics of diesel fuels	45
Diesel fuels available by region	46
Replacing the fuel filter	46
Addition of flow improvers	46
Measures required in the event of pre-existing paraffin separation	47
Opening/closing the fuel filler cap	47

BlueTec® exhaust gas cleaning system 49

AdBlue® service product 50

AdBlue® supply tank installation location 52

Filling with AdBlue® 52

Diesel particulate filter 54

Diesel particulate filter regeneration 56

Starting regeneration of the diesel particulate filter manually (parked regeneration) 58

Operating/malfunction displays: fuel system/exhaust gas cleaning system 60

Operating 230/400 V systems (option) 62

Function description: accident data recorder (ADR) (option) 62

Anti-jackknifing protection during forward travel 64

Anti-jackknifing protection during reverse travel 65

Passenger stop request 66

Ramp request 67

Safety instructions for the operation of mechanically folding/electric ramps (options) 68

Folding the ramp in/out 69

Table of contents

Retracting/extending the electric ramp (option)	71
Opening the hinged window	75
Care and cleaning	76
Tilting a rear seat	77
Tilting the seat row on the transmission cover	78
Care and cleaning of covers and upholstery	79
Care/cleaning of fabric covers	79
Malfunction displays: Yellow warning level - description	81
Malfunction display: Red warning level	82

Running-in guideline

- ▶ Running in the chassis and drive train.

**Note:**

The way in which the chassis and drive train of the new bus are treated during the first 3,000 miles (5,000 km) is critical to the future performance and service life of the bus.

**Note:**

During the first 3,000 miles (5,000 km), the load to which the bus is subjected should be increased only gradually. The maintenance and lubrication tasks specified in the Maintenance Record should be carried out conscientiously.

**Caution:**

Do not place the engine under full load during the first 3,000 miles (5,000 km). Up to 1,200 miles (2,000 km): run in with care. Do not drive at any more than 3/4 of the maximum engine speed for each gear. After 1,200 miles (2,000 km): slowly increase to the economic rpm in each gear. During the first 3,000 miles (5,000 km), do not drive the bus for long distances at a constant road speed or engine speed. Varying engine speeds and therefore varying loads demanded of the drive train are favourable to the running-in of the bus.

Starting the engine

**Note:**

Precondition: Parking brake applied, transmission in neutral.

**Note:**

At outside temperatures of below -20 °C, preheat the engine using the auxiliary heating (refer to “Heating/ventilation/air-conditioning control panel”).

Starting the engine



M54.00-2270-71

- ▶ Turn the key to drive position (2).



M54.00-2307-71

Operating displays are displayed one after the other during initialisation of electrical systems.

i Note:

Before you start the engine, wait until the electrical systems have been initialised and the “Bus stop” indication display appears on the screen.



M54.00-2372-71

i Note:

The engine cannot be started with the engine flap open; yellow alert (1) appears on the display screen and “Pop-up window” (2) is displayed.

- ▶ Turn the key to starting position (3). Do not depress the accelerator pedal. Release the key as soon as the engine starts.

**Note:**

If the engine does not start, interrupt the starting procedure after a maximum of 15 seconds, wait approximately 1 minute, and try again. Turn the key back to its initial position (0) before the next starting attempt. Introduce a pause (approximately 15 minutes) after three starting attempts. Release the key after the engine starts. Observe the indicator lamps immediately after the engine has started. If no malfunction is indicated, it is possible to pull away.

**Caution:**

If the “Oil pressure too low” symbol is displayed on the display screen, switch off the engine immediately and determine the cause.

**Caution:**

If the “No oil pressure” symbol is displayed on the display screen, switch off the engine immediately and determine the cause.

**Note:**

The engine should not be placed under full load until it has reached normal operating temperature (75 °C to 90 °C depending on operating conditions and the outside temperature).

**Danger.**

Never lock the steering while the bus is in motion. Whenever you disembark, even for a short time, always remove the key so that the bus cannot be started by children or other unauthorised persons.

**Environmental protection**

Never warm up the engine by allowing it to idle with the bus stationary. Instead, drive off and operate the engine at moderate engine speeds.

Driving

Driving



Danger.

All doors must be unlocked before the bus is driven off.



Danger.

The freedom of movement of the pedals must not be restricted. The operating safety and roadworthiness of the bus would otherwise be at risk. Objects could fall and get caught between the pedals if you were to accelerate or brake suddenly, with the result that you would no longer be able to brake or accelerate. You could cause an accident and endanger yourself and others.

- ▶ Check the freedom of movement of the pedals.



Danger.

Where floor mats and carpets are fitted, make sure that these are safely secured against slipping and that the pedals have sufficient clearance.



Danger.

Do not stow any objects in the driver's footwell.



Danger.

Stow and secure all loose objects in such a way that they cannot get into the driver's footwell when the bus is in motion.

- ▶ Keep an eye on the rev counter while driving.



Note:

Keep within the economical operating range. Make sure that the engine speed does not enter the danger zone (red zone).



Danger.

Test the service brake immediately after pulling away.

Stopping the engine



M54.00-2271-71

- ▶ Stop the bus, shift transmission to neutral, apply parking brake. Turn the ignition starter switch from position (2) back to position 1.

Danger.

There is a risk of fire and burns due to the high exhaust temperatures and the hot exhaust pipe for the auxiliary heating. For this reason, avoid parking the bus where ignitable material (e.g. dry grass, leaves, etc.) is in close proximity to the exhaust system, engine and auxiliary heating exhaust system.

Note:

To avoid engine damage, do not under any circumstances switch the engine off immediately after a long period of driving under full load (elevated coolant temperature, e.g. after hill climbing). Leave the engine running at idling speed for approximately 1 to 2 minutes to allow the exhaust gas turbocharger to cool down.

Towing with a tow bar (rigid buses)

Danger.

Only authorised specialists (recovery services) are permitted to tow away broken-down buses. The rules and regulations in the country concerned must be observed.

Caution:

Special measures are required in order to protect the transmission if the bus is to be towed: For safety reasons the propeller shaft must always be removed. The propeller shaft securing screws at the axle flange must be removed and those at the transmission flange secured against displacement.

Towing with a tow bar (articulated buses)



Danger.

The ignition starter switch of the vehicle being towed must always remain in position 2 during the towing procedure. The steering lock must not be allowed to engage. Failure to comply with this guideline could result in the steering locking. Safety-relevant functions would no longer be operational.



Note:

The front flap must remain closed for the duration of the towing procedure.



Note:

The towing coupling is suitable only for towing vehicles having a gross weight of no more than 18 tonnes.



Note:

The towing coupling must not be used for towing trailers.

Towing with a tow bar (articulated buses)



Danger.

Only authorised specialists (recovery services) are permitted to tow away broken-down buses. The rules and regulations in the country concerned must be observed.



Caution:

Special measures are required in order to protect the transmission if the bus is to be towed: For safety reasons the propeller shaft must always be removed. The propeller shaft securing screws at the axle flange must be removed and those at the transmission flange secured against displacement.

Towing with the front axle raised (rigid and articulated buses)

**Danger.**

The ignition starter switch of the vehicle being towed must always remain in position 2 during the towing procedure. The steering lock must not be allowed to engage. Failure to comply with this guideline could result in the steering locking. Safety-relevant functions would no longer be operational.

**Note:**

The front flap must remain closed for the duration of the towing procedure.

**Note:**

The towing coupling is suitable only for towing vehicles having a gross weight of no more than 18 tonnes.

**Note:**

The towing coupling must not be used for towing trailers.

Towing with the front axle raised (rigid and articulated buses)**Danger.**

Only authorised specialists (recovery services) are permitted to tow away broken-down buses. The rules and regulations in the country concerned must be observed.

**Caution:**

Special measures are required in order to protect the transmission if the bus is to be towed: For safety reasons the propeller shaft must always be removed. The propeller shaft securing screws at the axle flange must be removed and those at the transmission flange secured against displacement.

**Danger.**

The ignition starter switch must not be switched to position 1 or 2 while the front axle is raised. The wheels on the driven axle may lock. Disregard for this warning could result in brake intervention

Front towing coupling

by ABS/ASR, which could cause the rear axle to skid. Articulated buses: Above a speed of 12 km/h, this could happen even sooner, whether during straight-ahead travel or with the articulation at an angle. In addition, the bus stop brake would be activated by the articulation angle control unit.



Caution:

Articulated buses: With the ignition starter switch in position 0, articulation protection is in emergency damping mode. Articulation protection and vehicle stabilisation functions are extremely limited in this mode.

Front towing coupling

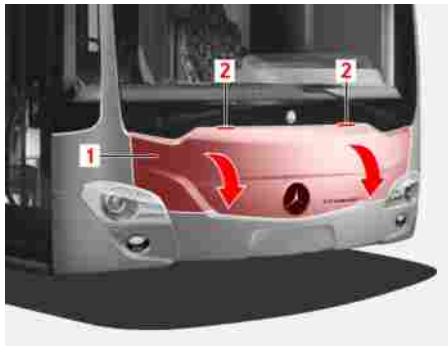

M88.00-0100-71

- ▶ Grasp handle recesses (2) with both hands and open front flap (1).

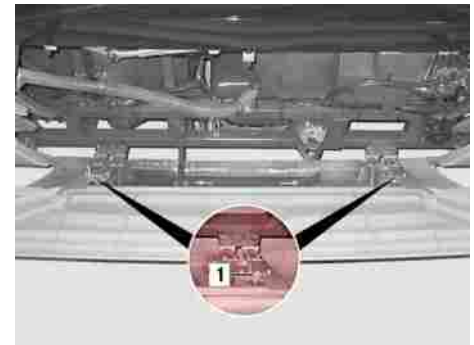

M00_00-0338-71

- ▶ Move the levers on both flap locks (1) to the left (when viewed in the direction of travel) to release the lower section of the front flap.

The lower section of the front flap folds down.



Note:

A retention strap prevents the lower section of the front flap from folding down completely.

Rear towing coupling (option)

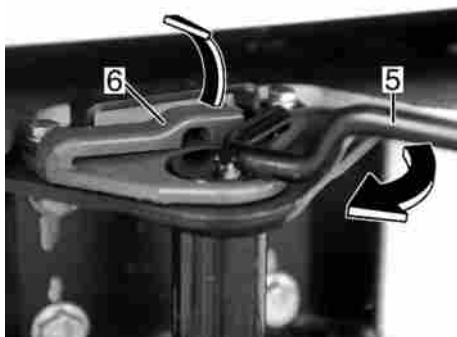

M88_00-0060-01

- ▶ Lift locking tab (6) slightly and turn the linchpin clockwise by handle (5) until it is released.
- ▶ Pull the linchpin up and out of the towing coupling.
- ▶ Fit the eyelet of the tow bar into the towing coupling.
- ▶ Fit the linchpin into the towing coupling and eyelet of the tow bar.

- ▶ Turn the linchpin anti-clockwise by handle (5) until locking tab (6) engages.

i **Note:**

The linchpin must remain engaged in locking tab (6) at all times.

- ▶ Close the front flap.

Rear towing coupling (option)

- ▶ Remove the linchpin from the front towing coupling.

i **Note:**

The rear towing coupling is optional equipment and has no linchpin.

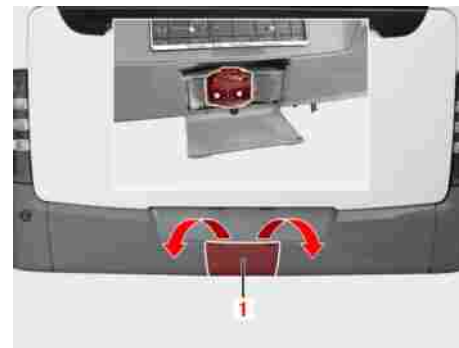

M00_00-0492-71

- ▶ Remove cover (1).
- ▶ Fit the eyelet of the tow bar into the towing coupling.

Brake system safety precautions

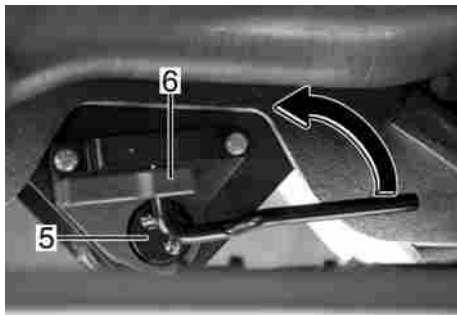

M88_00-0061-01

- ▶ Fit linchpin (5) into the towing coupling and eyelet of the tow bar.
- ▶ Turn linchpin (5) anti-clockwise by the handle until locking tab (6) engages.



Note:

Linchpin (5) must remain engaged in locking tab (6) at all times.

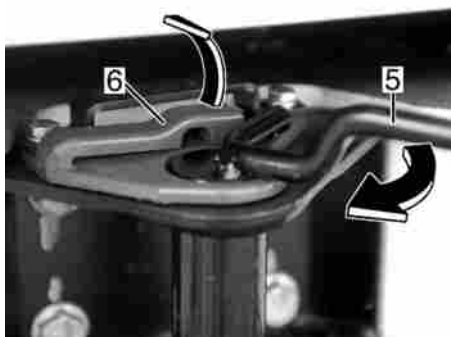

M88_00-0060-01

- ▶ At the end of towing, lift locking tab (6) slightly and turn the linchpin clockwise by handle (5) until it is released.
- ▶ Refit the linchpin into the front towing coupling and secure it.

Brake system safety precautions



Caution:

The braking characteristics of the bus may change if a yellow warning level malfunction in the brake system appears on the instrument cluster display screen. Adopt a particularly cautious driving style. Have the malfunction rectified as soon as possible by an OMNIplus Service Partner.



Danger.

The braking characteristics of the bus have changed if a red warning level malfunction in the brake system is displayed. Pedal travel may increase under braking. ABS has been disabled. Stop the bus immediately and disable it (traffic conditions permitting). Have the malfunction rectified by an OMNIplus Service Partner immediately.

Charging point for external compressed-air source

Charging point for external compressed-air source



M42.00-0855-71

Charging point (1) for an external compressed-air source is located behind the front flap on the right-hand side (example).

Note:

The minimum and maximum pressures to be observed will differ, depending on the variant of external source concerned. Cleaned and dried air may also be required, depending on the variant used.



Caution:

Disregard for these notes could result in damage to the compressed-air system.



Note:

You can obtain further information from any EvoBus Service Partner

Braking and stopping

- ▶ Whenever the bus is driven for long distances downhill, you should make use of the braking effect of the engine by shifting into a lower gear range. To relieve the service brake of load, use the integrated retarder in accordance with the manufacturer's operating instructions.



Note:

Except for emergencies, the service brake does not usually need to be applied sharply.



Danger.

Always apply the parking brake before you leave the driver's area. On steep uphill and downhill gradients, you should also chock the wheels and turn the steering towards the kerb.

Brakes with anti-locking protection

Brakes with anti-locking protection

- ▶ In a hazardous situation, the brake pedal should be depressed fully. This ensures that all wheels are braked with ABS assistance and optimum deceleration is achieved.



Note:

The retarder is deactivated automatically for the duration of an ABS control intervention.



Danger.

The anti-locking protection of ABS does not relieve the driver of the responsibility for adopting a driving style which takes traffic and road conditions into account. While the directional stability and steerability of the bus are improved under braking, ABS is not able to avert the consequences of, for example, driving at an unsafe distance behind a vehicle in front or driving too fast through bends.



Danger.

If the bus is towing a trailer that does not have ABS, this trailer could be overbraked if the brakes were applied with maximum force. In this case, the driver must keep an eye on the trailer in the rear-view mirror. The bus equipped with ABS remains steerable, thereby enabling the driver to keep it stable.

Operating pressure



Note:

Precondition: Operating pressure at least 6.8 bar in circuit 1 and circuit 2, and at least 5.5 bar in circuit 3 auxiliary consumers circuit



Danger.

Risk of accident. To ensure maximum operating safety and reliability, a supply pressure of at least 6.8 and 5.5 bar is required in the individual compressed-air circuits. A leaking compressed-air brake system jeopardises the operating safety and roadworthiness of the bus. Stop immediately (traffic conditions permitting) if the supply pressure in the brake system is too low. Have the brake system checked at an OMNIplus Service Partner.

Operating/malfunction displays: brake system



M54.00-2361-71

- ▶ Select the monitoring menu, operating pressure submenu.

The following appears on the display screen: Present “supply pressure” in brake circuits 1 and 2 (max. 12.0 bar) and circuit 3 auxiliary consumers (max. 9.0 bar).

Operating/malfunction displays: brake system

“Parking brake applied” indication display (A)

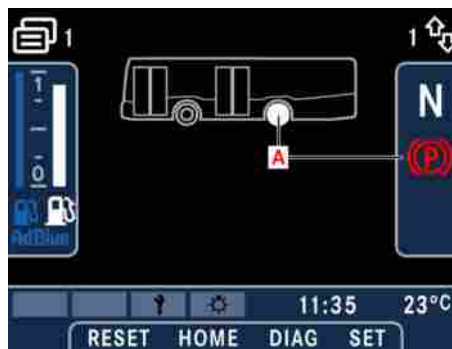

M54.00-2334-71

Bus stop brake/drive-off lock malfunction

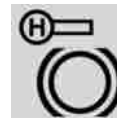

If this symbol is displayed, either the bus stop brake is defective or the emergency release switch of the bus stop brake has been operated.

Operating/malfunction displays: brake system

“Brake circuits 1 and 2 supply pressure” indication display



M54.00-2363-71

Screen display: Present “supply pressure” in brake circuits 1 and 2 too low.



Note:

Red warning level.

“Supply pressure in auxiliary consumers circuit 3” indication display



M54.00-2362-71

Screen display: Present “supply pressure” in auxiliary consumers circuit 3 too low.



Note:

Yellow warning level.

Brake pad wear



An overly worn brake pad is indicated on the display screen by a service notification and a yellow warning level malfunction alert.



Danger.

The braking characteristics of the bus may change if a yellow warning level malfunction relating to brake system is shown on the display screen. Adopt a particularly cautious driving style. Have the malfunction rectified as soon as possible by an OMNIplus Service Partner.

Electronic Stability Program (ESP) (option) - (system description)

Electronic Stability Program (ESP) (option) - (system description)

Dynamic handling control (FDR) acts to prevent the bus from skidding or tilting (subject to the laws of physics), regardless of vehicle load and road surface conditions, and particularly in critical driving situations (e.g. sudden evasive manoeuvre or high cornering speed). This is achieved by selective braking of individual wheels or, where necessary, all wheels. The Electronic Stability Program ESP is a combination of dynamic handling control FDR and acceleration skid control ASR. ESP remains operational even when the service brake is applied or a continuous brake is active.

**Danger.**

RISK OF ACCIDENT. The Electronic Stability Program (ESP) does not relieve the driver of the responsibility for adopting a driving style which takes traffic and road conditions into account. The ability of ESP to restabilise the bus is subject to the laws of physics. The bus may skid

out of control if the Electronic Stability Program (ESP) has been deactivated and the drive wheels start to spin.

**Note:**

In wintry conditions, optimum performance of the Electronic Stability Program (ESP) cannot be achieved unless winter tyres (M+S) are fitted.

**Note:**

It is recommended that the Electronic Stability Program (ESP) be deactivated using ESP OFF pushbutton (1) if traction problems are experienced when driving with snow chains fitted or over loose surfaces (e.g. sand or gravel).



M54.00-2249-82

Electronic Stability Program (ESP) function description

Electronic Stability Program (ESP) function description

Functions:

- Electronic Stability Program (ESP) function description
- Initialisation phase
- Handling in the event of understeering
- Handling in the event of oversteering

Electronic Stability Program (ESP) function description



M54.00-2375-71

If ESP detects a critical driving situation, automatic control interventions stabilise the bus by:

- reducing engine power output
- selectively braking individual wheels
- applying the brakes at all wheels



Note:

Indicator lamp (1) flashes while the Electronic Stability Program (ESP) is intervening.



Note:

Dynamic handling control (FDR) is active only at speeds of over 10 km/h. Dynamic handling control (FDR) is deactivated whenever reverse gear is selected.



Note:

The Electronic Stability Program (ESP) is deactivated automatically in the event of an ESP malfunction or a technically related malfunction in the Electronic Brake System.

Electronic Stability Program (ESP) function description

Initialisation phase

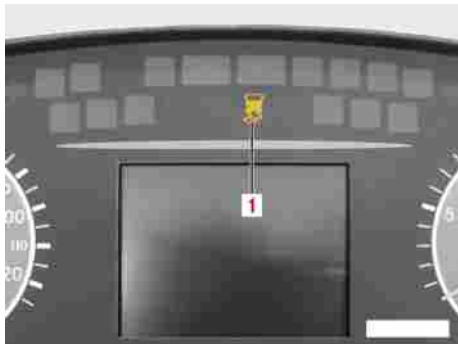

M54.00-2375-71

Whenever the ignition starter switch is switched to ON, the Electronic Stability Program (ESP) undergoes an initialisation process that lasts until the first few metres have been driven and the sensors are checked for correct function. Dynamic handling control (FDR) is not yet functional during the initialisation phase, although acceleration skid control (ASR) is operational. If the system determines that correct operation is guaranteed, initialisation is completed and the system is ready for operation. Indicator lamp (1)

lights up for the duration of the initialisation phase.

Handling in the event of understeering

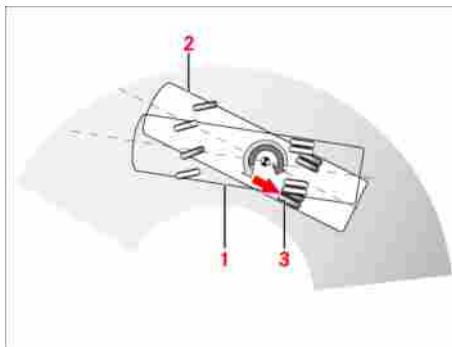

M42_25_0003_01

The front axle of the bus deviates from steered course (1) towards the offside of the road (2). Selective braking of the rear wheel on the nearside (3) restabilises the bus.



Note:

The illustration shows a 2-axle bus as an example. In the case of 3-axle buses equipped with RAS, the 3rd axle is regulated separately as necessary.

Handling in the event of oversteering

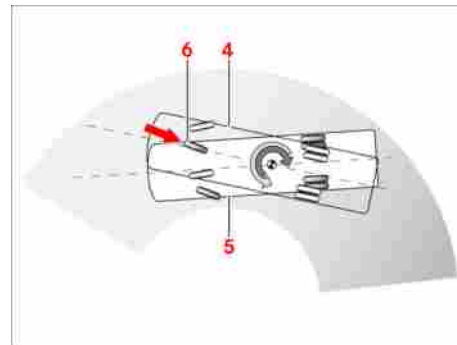

M42_25_0002_01

The bus breaks out at the rear axle. The bus deviates from steered course (4) and turns towards the near side of the road (5). Selective braking of the front wheel on the offside (6) restabilises the bus.

Deactivating the Electronic Stability Program (ESP)



Note:

The illustration shows a 2-axle bus as an example. In the case of 3-axle buses equipped with RAS, the 3rd axle is regulated separately as necessary.

Deactivating the Electronic Stability Program (ESP)



M54.00-2249-82

- ▶ Press ESP OFF pushbutton (1).



Note:

Pressing “ESP OFF” pushbutton (1) again or switching the ignition starter switch to OFF and back to ON reactivates the Electronic Stability Program (ESP).



Danger.

RISK OF ACCIDENT. The bus may skid out of control if the Electronic Stability Program (ESP) has been deactivated and the drive wheels start to spin.



Note:

It is recommended that the Electronic Stability Program (ESP) be deactivated using ESP OFF pushbutton (1) if traction problems are experienced when driving with snow chains fitted or over loose surfaces (e.g. sand or gravel).

Activating and deactivating acceleration skid control (ASR)

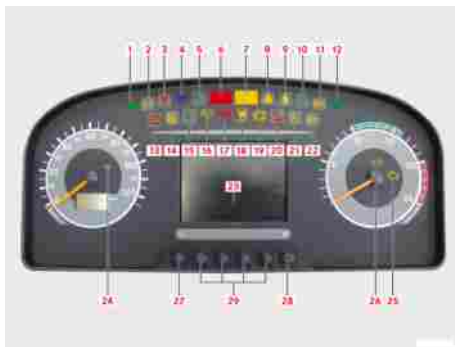

M54.00-2374-76

- Dynamic handling control (FDR) and acceleration skid control (ASR) are disabled. Indicator lamp (18) lights up permanently.

Activating and deactivating acceleration skid control (ASR)

i **Note:**

If traction problems are experienced when driving with snow chains fitted or on loose surfaces (e.g. sand and gravel): Deactivate acceleration skid control.



M54.00-2286-71

- Press pushbutton (1) with the ignition starter switch switched on in position 2.

! **Danger.**

The bus may skid out of control if ASR has been switched off and the drive wheels start to spin.

- Pressing pushbutton (1) again or switching the ignition starter switch to OFF and back to ON reactivates acceleration skid control.

Operating/malfunction displays: ABS/ASR

Operating/malfunction displays: ABS/ASR

ABS/ASR malfunction



In the event of an ABS/ASR failure or malfunction, a red or yellow warning level malfunction, depending on fault severity, is displayed on the display screen.



Note:

If a yellow warning level malfunction is displayed after the ignition has been switched on, release the parking brake and depress the brake pedal fully for 2 seconds. If the fault alert continues to be displayed, pull away and continue to monitor the display. If the fault alert is still present even after you have pulled away, it is necessary to visit a workshop.



Danger.

The wheels could lock, especially on a slippery surface - risk of skidding.



Danger.

The braking characteristics of the bus may change if a yellow warning level malfunction relating to brake system is shown on the display screen. Adopt a particularly cautious driving style. Have the malfunction rectified as soon as possible by an OMNIplus Service Partner.



Danger.

The braking characteristics of the bus have changed if a red warning level malfunction is displayed on the display screen. Pedal travel may increase under braking. ABS has been disabled. Stop the bus immediately and disable it (traffic conditions permitting). Have the malfunction rectified by an OMNIplus Service Partner immediately.

Acceleration skid control (ASR) active



ASR is activated automatically if the drive wheels on one or both sides start to spin. An active ASR intervention is indicated by this icon in the Driving operating display menu on the display screen. If the drive wheels on one side start to spin, they will be braked automatically. - If the drive wheels on both sides start to spin, engine power output will be reduced automatically.



Danger.

Risk of accident. Acceleration skid control does not relieve the driver of the responsibility for adopting a driving style which takes traffic and road conditions into account.

Disabling retarder activation by brake pedal (option)

Deactivating acceleration skid control (ASR)



Acceleration skid control can be deactivated using “ASR OFF” pushbutton (1).

i **Note:**

This icon appears on the display screen.

! **Danger.**

Risk of accident. The bus could skid if ASR has been switched off and the drive wheels start to spin.

Disabling retarder activation by brake pedal (option)

i **Note:**

This switch is for use mainly in wintry road conditions so that the driver can moderate the braking effect more effectively.

i **Note:**

Disabling the retarder results in increased wear of the brake pads.



M54.00-2253-82

► Press the lower section of switch (1).

i **Note:**

The retarder is now decoupled from the service brake and is no longer operated when the brake pedal is depressed.

Retarder direct (customer specification)

- ▶ Press the upper section of switch (1).



Note:

The retarder is coupled with the service brake again and is operated when the brake pedal is depressed.

- ▶ Depress the brake pedal.



The following appears on the display screen: “Retarder active”.

- ▶ Release the brake pedal.

The “Retarder active” indication display on the display screen goes out.

Retarder direct (customer specification)



Danger.

Risk of accident. To protect the retarder from overheating during continuous operation, the retarder's braking effect is reduced automatically as a function of the operating temperature. Adjust your driving style, particularly on long downhill gradients. Do not activate the retarder when the road is slippery as the wheels may lock (risk of skidding).



Note:

Use of this function increases fuel consumption.



M54.00-1780-71

- ▶ Press down switch (2).

The retarder is ready for operation.

- ▶ Fully release the accelerator pedal.

The bus is braked directly by the maximum retarder stage.



The following appears on the display screen: “Retarder active”.



Note:

With switch (2) pressed down, it is necessary to release the accelerator pedal completely to permit braking with the retarder.

- ▶ Depress the accelerator pedal.

Braking of the bus by the maximum retarder stage is interrupted.



Note:

Whenever the accelerator pedal is operated, retarder braking will be interrupted until the accelerator pedal is fully released again.



The “Retarder active” indication display on the display screen goes out.



M54.00-1780-71

- ▶ Press the upper section of switch (2).
Braking of the bus by the maximum retarder stage is disabled.

Refuelling (diesel fuel)

The vehicle has a two-tank system fitted to the front of the front axle. The fuel tanks are interconnected through their bases by a fuel line. The bus can be refuelled from either side. If the fuel tanks on your bus are interconnected, it is necessary to remove the fuel cap from each of the fuel tanks.

The addition of flow improvers is not permitted.

Switch off the engine and auxiliary heating before refuelling. Turn the ignition starter switch back to position 0. Park the bus on a level surface.

Cleanliness is of utmost importance when refuelling. Do not leave cotton rags or cloths in the vicinity of the open filler neck.

Close the fuel tank properly once filling is complete.

Refuelling (diesel fuel)



Caution:

Refuel using only commercially available, sulphur-free diesel fuel complying with European standard EN 590 as revised from 2010 onwards (max. 0.001 % sulphur by weight). Fuels containing more than 0.001 % sulphur by weight or other types of fuel such as marine diesel fuel, heating oils or fatty acid methyl ester FAME (biodiesel fuel) are not permitted. These types of fuel would cause irreversible damage to the engine and BlueTec®6 exhaust gas aftertreatment system and considerably reduce expected service life.



Danger.

Risk of injury and explosion. Fuel is highly flammable. Fire, naked flames and smoking are therefore prohibited when fuel is being handled.



Danger.

Before refuelling, switch off the auxiliary heating to prevent fuel vapours from igniting on the auxiliary heating exhaust system.



Danger.

Fuel is toxic and harmful to health. For this reason, make sure that the fuel does not come into contact with skin, eyes or clothing, that you do not inhale fuel vapours and that children are kept away from the fuel.



Danger.

If you or others have come into contact with fuel: In case of contact with the eyes, rinse them immediately and copiously with clean water and seek medical attention. Clean affected areas of skin immediately with soap and water. Immediately change out of clothing that has come into contact with fuel. If fuel has

been swallowed, seek medical attention immediately.



Environmental protection

If handled improperly, fuels constitute a hazard to health and the environment. Fuels must not be allowed to enter the sewerage system, surface water, ground-water or soil.

Service products

Service products are: fuels, lubricants (e.g. engine oils, transmission oils, greases), coolants, brake fluids, etc.

Structural parts and service products must be matched to each other. For this reason, only brands that have been approved by EvoBus are permitted to be used. These are stipulated in the EvoBus Specifications for Service Products.



Danger.

Risk of injury. Service products are harmful to health. Seek medical attention immediately if a service product has been swallowed. Avoid inhaling fumes where possible. Do not allow service products to come into contact with skin, eyes or clothing. Clean all affected areas of skin with water and soap. In case of contact with the eyes, rinse the eyes thoroughly with clean water. Change out of contaminated clothing immediately. Keep service products away from children.



Environmental protection

Incorrect handling of service products may endanger human life and the environment. Service products must not be allowed to enter the sewerage system, surface water, ground water or soil. Dispose of service products and containers and components that have come into contact with service products (e.g. filters) in an environmentally responsible manner. Comply with legal requirements.

AdBlue® service product

AdBlue® is a non-flammable, non-toxic, colourless, odourless, water-soluble liquid.



Caution:

Use only AdBlue® complying with DIN 70 070. Special additives are not permitted.



Caution:

If, during a top-up, AdBlue® comes into contact with painted or aluminium surfaces, rinse down these surfaces with water immediately.

Properties of AdBlue® at high temperatures



Note:

Ammonia vapours may be produced if the content of the AdBlue® tank is heated to over 50 °C for a lengthy period (e.g. as a consequence of direct sunlight).

AdBlue® service product



Note:

Ammonia vapours have an acrid odour. For this reason, you should avoid inhaling any ammonia vapours that may escape when you remove the AdBlue® filler cap. Ammonia vapours are neither toxic nor hazardous to health in this concentration.

Storage



Caution:

For the storage of AdBlue®, use only containers made from plastic, high-alloy CrNi steels or MoCrNi steels complying with DIN EN10088-1/2/3. Containers made of aluminium, copper, cupriferous alloys and non-alloyed or galvanised steels are not suitable for the storage of AdBlue®. If stored in such containers, AdBlue® could dissolve out constituents of these metals and destroy the exhaust gas cleaning system. The vehicle warranty will be invalidated if damage to the exhaust gas cleaning system is found to have been caused by constituents dissolved out of non-approved storage containers.

Properties of AdBlue® at low temperatures



Note:

AdBlue® freezes at a temperature of approximately -11 °C. The bus is equipped with an AdBlue® preheating system as standard. Winter operation is thus ensured, even at temperatures below -11 °C.

Disposal of AdBlue®



Environmental protection

Observe country-specific legislation and requirements governing the disposal of AdBlue®.

AdBlue® additives



Caution:

Do not add any additives to AdBlue®. Do not dilute AdBlue® with tap water. Doing so could destroy the exhaust gas cleaning system. Damage to the exhaust gas cleaning system caused by additives or tap water will invalidate the warranty.

AdBlue® purity



Note:

It is prohibited to return to the tank any AdBlue® that has been pumped out, e.g. during a repair, because the purity of the liquid would no longer be guaranteed.

Winter operation with diesel fuels for buses with fuel-lubricated injection systems

Winter operation with diesel fuels for buses with fuel-lubricated injection systems

WARNINGS:

**Danger.**

Risk of fire and explosion. Petrol must never be mixed with diesel fuel.

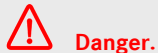
**Danger.**

Risk of fire and explosion. If paraffin has already separated and this has caused operational malfunctions, do not under any circumstances heat components using sources of heat, e.g. heaters, heat radiators, hot air blowers or blow torches. Risk of damage to components. Risk of fuel escaping.

**Note:**

Please observe the further notes in the text.

▷ Further notes on winter operation with diesel fuel can be found on Mercedes-Benz Specifications for Service Products sheet 137.0.

Low-temperature characteristics of diesel fuels

At subzero outside temperatures, the filterability or fluidity (low-temperature characteristics) of diesel fuel could deteriorate as a consequence of paraffin crystal separation.

On average, the temperature values for filterability (low-temperature characteristics) of diesel fuel are 0 °C in the summer, -20 °C in winter and -10 °C in the transition period. During particularly cold spells or if diesel fuel with inadequate low-temperature behaviour is used for refuelling, there is a risk of malfunctions occurring if no precautions are taken to prevent paraffin separation.

Diesel fuels available by region

Diesel fuels available by region

If a cold spell is encountered when driving from warmer to colder regions, it is essential to change over immediately to the diesel fuel conventionally used in the region.

Replacing the fuel filter

With the use of diesel fuels having a high water content, the fuel filter should be replaced with a new one before the onset of winter. This is a precautionary measure to prevent the fuel filter from icing up.

▷ For fuel filter instructions, refer to maintenance information.

Addition of flow improvers

In the case of winter-grade diesel fuels with an operating reliability of $-20\text{ }^{\circ}\text{C}$ and below, the addition of a flow improver does not promote any further improvement in low-temperature characteristics because these fuels are already saturated with flow improvers.

The following must be taken into account when flow improvers are used:

- Summer diesel fuel: should be added when the fuel temperature is at least $+8\text{ }^{\circ}\text{C}$.
- Winter diesel fuel: should be added when the fuel temperature is at least $0\text{ }^{\circ}\text{C}$.
- Since diesel fuels vary in their properties, it cannot be guaranteed that every diesel fuel will react positively to the addition of flow improvers. In the case of particularly cold-resistant winter-grade diesel fuels, there could even be a deterioration in low-temperature characteristics. The subsequent addition of flow improvers is not recommended in this instance.

Measures required in the event of pre-existing paraffin separation

Measures required in the event of pre-existing paraffin separation

The addition of flow improvers has no effect if paraffin separation has already occurred. Paraffin separation must first be reversed to remedy the situation. This is achieved by heating the entire fuel system.

The fuel system should be heated by parking the bus in a heated indoor facility for a long period. The covers, of the engine compartment for instance, should be opened to accelerate the process.



Danger.

Risk of fire and explosion. Do not under any circumstances heat components using artificial sources of heat, e.g. heaters, heat radiators, hot air blowers or blow torches. Risk of damage to components. Risk of fuel escaping. Risk of fire.

Opening/closing the fuel filler cap

▷ Observe the general information on refuelling.



M88_00-0067-01

▶ Open the flap (1)

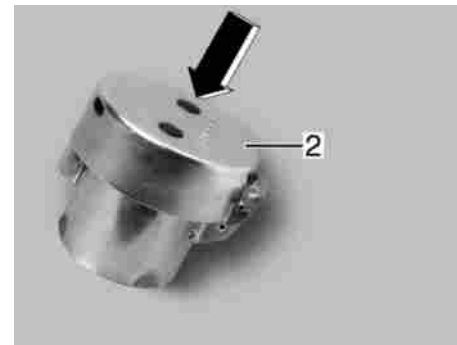

M47_00-0035-01

▶ Push fuel filler cap (2) downwards against the spring pressure.

Opening/closing the fuel filler cap

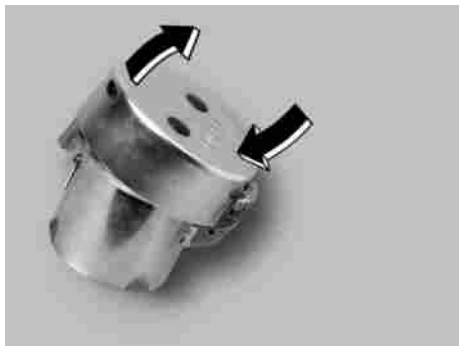

M47_00-0036-01

- ▶ Tilt the fuel filler cap.



M47_00-0037-01

- ▶ Open the fuel filler cap.

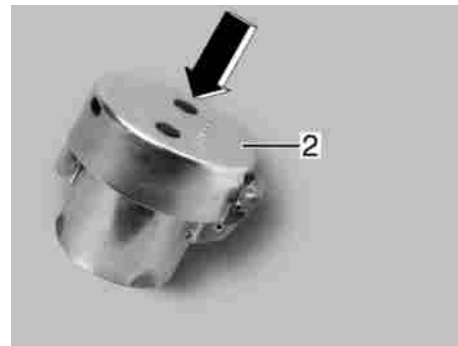

M47_00-0035-01

- ▶ Press fuel filler cap (2) downwards until the catch engages.

BlueTec® exhaust gas cleaning system

The BlueTec® exhaust gas cleaning system essentially comprises a supply tank, a catalytic converter and an AdBlue® metering system. It is monitored and controlled electronically. Pollutants in the exhaust gas are converted into environmentally friendly substances by the addition of AdBlue® and the catalytic converter integrated into the silencer.

To function correctly, the BlueTec® exhaust gas cleaning system requires the addition of a reducing agent (AdBlue®). The addition of AdBlue® does not form part of the routine scope of bus maintenance – it is the responsibility of the vehicle operators to ensure that the AdBlue® supply tank is regularly replenished. Filling and operating the bus with AdBlue® is mandatory for compliance with emission regulations and is thus one of the conditions for the road traffic approval of the bus. The road traffic approval of the bus will be invalidated if the bus is operated without AdBlue®. It

would then be against the law to operate the bus on public roads. In some countries, operation of the bus without AdBlue® may be considered to be a criminal offence or a violation of administrative law punishable by fine. Support in the purchase or operation of the bus, e.g. tax relief, road tax, may also be invalidated retrospectively. This may be the case both in the country in which the vehicle is registered and in other countries in which the vehicle is operated.



Danger.

It is essential that work relevant to safety or work on safety-related systems be carried out at a qualified specialist workshop.



Danger.

Always have maintenance work carried out at a qualified specialist workshop which has the necessary knowledge and tools.



Note:

AdBlue® freezes at a temperature of approximately -11 °C. The bus is equipped with an AdBlue® preheating system as standard. Winter operation is therefore guaranteed, even at temperatures of below -11 °C.



Environmental protection

AdBlue® is biologically degradable. Unless it is handled properly, however, AdBlue® constitutes an environmental hazard. Do not allow AdBlue® to enter the sewerage system, surface water, groundwater or soil in significant volumes.



Danger. Risk of poisoning and injury.

AdBlue® is not classified as a hazardous substance by German regulations governing hazardous substances. Nevertheless, certain points should be observed when handling AdBlue®.

The AdBlue® line system and the system components connected to it are pres-

AdBlue® service product

surised while the engine is warm. There is a risk of scalding from hot AdBlue® spraying out if the line system is suddenly opened. There is also the risk of skin irritation or damage to the eyes if AdBlue® comes into contact with the skin or eyes.

- Wear gloves
- Wear protective clothing
- Wear safety goggles
- Work on the exhaust gas aftertreatment system should not be commenced until approximately 4 minutes have passed as individual lines continue to be flushed even after the engine has been switched off.
- Switch the ignition starter switch to the "OFF" position and remove the key before work is carried out on the SCR system.
- Allow the AdBlue® line system to cool down
- Open line connections and system component covers/caps slowly.
- Capture any AdBlue® that escapes in a suitable container and dispose of it in an environmentally responsible manner.

- Do not pour AdBlue® into drinks containers.
- Wipe up any spilled AdBlue®, especially as there is a risk of slipping.
- AdBlue® collected in this way must not be poured back into the AdBlue® supply tank.
- Rinse affected areas of skin copiously with clean water.
- Quickly change out of clothing that has come into contact with the substance.
- In case of contact with the eyes, rinse them immediately and copiously with clean water and seek medical attention if necessary.
- If AdBlue® enters the mouth or is swallowed, rinse the mouth out with clean water and then drink plenty of water.
- Seek medical attention if symptoms persist.

AdBlue® service product

AdBlue® is a non-flammable, non-toxic, colourless, odourless, water-soluble liquid.



Caution:

Use only AdBlue® complying with DIN 70 070. Special additives are not permitted.



Caution:

If, during a top-up, AdBlue® comes into contact with painted or aluminium surfaces, rinse down these surfaces with water immediately.

Properties of AdBlue® at high temperatures



Note:

Ammonia vapours may be produced if the content of the AdBlue® tank is heated to over 50 °C for a lengthy period (e.g. as a consequence of direct sunlight).

**Note:**

Ammonia vapours have an acrid odour. For this reason, you should avoid inhaling any ammonia vapours that may escape when you remove the AdBlue® filler cap. Ammonia vapours are neither toxic nor hazardous to health in this concentration.

Storage

**Caution:**

For the storage of AdBlue®, use only containers made from plastic, high-alloy CrNi steels or MoCrNi steels complying with DIN EN 10088-1/2/3. Containers made of aluminium, copper, cupriferous alloys and non-alloyed or galvanised steels are not suitable for the storage of AdBlue®. If stored in such containers, AdBlue® could dissolve out constituents of these metals and destroy the exhaust gas cleaning system. The vehicle warranty will be invalidated if damage to the exhaust gas cleaning system is found to have been caused by constituents dissolved out of non-approved storage containers.

Properties of AdBlue® at low temperatures

**Note:**

AdBlue® freezes at a temperature of approximately -11 °C. The bus is equipped with an AdBlue® preheating system as standard. Winter operation is thus ensured, even at temperatures below -11 °C.

Disposal of AdBlue®

**Environmental protection**

Observe country-specific legislation and requirements governing the disposal of AdBlue®.

AdBlue® additives

**Caution:**

Do not add any additives to AdBlue®. Do not dilute AdBlue® with tap water. Doing so could destroy the exhaust gas cleaning system. Damage to the exhaust gas cleaning system caused by additives or tap water will invalidate the warranty.

AdBlue® purity

**Note:**

It is prohibited to return to the tank any AdBlue® that has been pumped out, e.g. during a repair, because the purity of the liquid would no longer be guaranteed.

AdBlue® supply tank installation location

AdBlue® supply tank installation location



Note:

The installation location may vary, depending on customer specification.



M54.00-2288-71

- ▶ AdBlue® supply tank (1), (Citaro rigid bus).



M00.00-0659-71

- ▶ AdBlue® supply tank (2), (Citaro G, Capa City).

Filling with AdBlue®



Note:

An accidental filling of the AdBlue® supply tank with diesel fuel and vice versa is prevented by various technical precautionary measures.



Note:

AdBlue® is consumed at a rate of approximately 2 % - 2.5 % of the rate of diesel fuel consumption. It is recommended that the AdBlue® supply tank also be refilled at every regular refuelling stop.



Caution:

Use only AdBlue® complying with DIN 70 070. Special additives are not permitted.



Caution:

If, during a top-up, AdBlue® comes into contact with painted or aluminium surfaces, rinse down these surfaces with water immediately.



Note:

AdBlue® freezes at a temperature of approximately -11 °C. The bus is equipped with an AdBlue® preheating system as standard. Winter operation is thus ensured, even at temperatures below -11 °C.



M54.00-2289-71

- Read AdBlue® fill level (1)



M54.00-2290-71

If the fill level in the AdBlue® supply tank falls to approximately 10 %, a yellow alert (1) appears on the display screen. The yellow alert displays “AdBlue®” icon (1.1) and the message “AdBlue® Vorrat zu gering” (AdBlue® level too low) (1.2). The driver can acknowledge yellow alert (1) at any time using main menu buttons (1.3) on the steering wheel. AdBlue® indicator (2) turns yellow and remains lit to remind the driver that an AdBlue® top-up is due. Yellow warning lamp (3) does not go out un-

Diesel particulate filter

til the vehicle has been refilled with AdBlue®.

The driver is informed by an icon on the display screen (1.1) in conjunction with a yellow alert if the AdBlue® supply tank runs empty or if there is a malfunction in the BlueTec exhaust gas cleaning system. In this event, it is necessary to top up the AdBlue® level without delay or to remedy the fault.

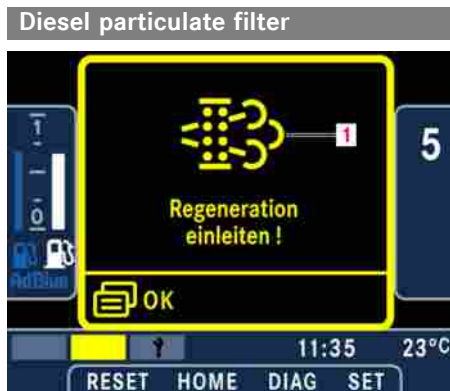

M54.00-2291-71

Under normal circumstances, automatic regeneration of the diesel particulate filter is sufficient to avoid heavy soot loading of the filter. However, if the bus is predominantly driven short distances or with the engine under low load, it might not be possible for automatic regeneration to finish successfully.

Before the diesel particulate filter load state becomes critical, pop-up window (1) appears on the display screen with the message “Regeneration einleiten!” (Initiate regeneration!).

If this yellow alert and its instruction are disregarded, there is a risk of engine power output being reduced and a need to exchange the diesel particulate filter prematurely.



Note:

As long as no flashing yellow or constant red malfunction alert appears, it can also be sufficient to alter the load profile (e.g. route with high proportion of continuous driving) in order to ensure that automatic regeneration of the diesel particulate filter finishes successfully.



Note:

In the event of a malfunction in the BlueTec® exhaust gas aftertreatment system, have the system checked and repaired at a qualified specialist workshop.

approximately 30 to no more than 60 minutes.

**Note:**

The time needed for manual regeneration is dependent on the temperature of the exhaust system.

**Note:**

If the yellow event window and its message are disregarded, there is a risk of engine power output being reduced and a need to exchange the diesel particulate filter prematurely.

**Danger.**

Exposure to diesel soot and soot particles through contact or inhalation is harmful to health and can lead to death. If you need to exchange a diesel particulate filter yourself due to technical problems, be sure to observe the information and instructions in the workshop information and all applicable occupational safety and accident-prevention regulations. Wear

**Danger.**

Exhaust fumes are produced during the manual regeneration process (parked regeneration). If you were to inhale these exhaust fumes, you could suffer harmful effects such as poisoning. For this reason, the bus should always be parked outdoors. If, however, the bus is parked in an enclosed room, adequate ventilation must be ensured.

**Danger.**

Very hot exhaust fumes are expelled from the exhaust tail pipe during the manual regeneration process (parked regeneration). Keep well clear of the exhaust tail pipe. Otherwise, you could be burned by the fumes. The use of an extraction system should be avoided because this will generally not have been designed to withstand the exhaust temperature levels that arise.

**Danger.**

Make sure that no highly flammable materials, e.g. dry grass or fuels, come into contact with the exhaust system during the manual regeneration process (parked regeneration). Do not leave the bus parked up at a filling station, on dry grass or on harvested crop fields. The hot exhaust system could otherwise cause the highly flammable material to ignite and set the bus on fire.

**Danger.**

The exhaust tail pipe has been designed in such a way that the exhaust gas temperature falls relatively quickly with increasing distance. For this reason, no other exhaust tail pipe may be fitted.

If the diesel particulate filter load state becomes critical, another pop-up window appears with the message “Regeneration sofort einleiten!” (Initiate regeneration immediately!). Initiate regeneration manually (parked regeneration). The manual regeneration process lasts

Diesel particulate filter regeneration

gloves and a dust mask. Seal and pack a particle-laden diesel particulate filter in the original packaging immediately after removal. A particle-laden diesel particulate filter must be labelled and must not under any circumstances be left uncovered indoors.

▷ For instructions on how to initiate diesel particulate filter regeneration manually (parked regeneration), refer to the “Starting regeneration of the diesel particulate filter manually” section.

Diesel particulate filter regeneration

Functions:

- Automatic regeneration of the diesel particulate filter
- Inhibiting automatic regeneration of the diesel particulate filter
- Catalytic converter protection function

Automatic regeneration of the diesel particulate filter

Whenever the green “Particulate filter” indicator lamp  in the instrument cluster lights up, this means that the diesel particulate filter is undergoing automatic regeneration.



Note:

Automatic regeneration does not start unless all necessary operating conditions have been fulfilled, e.g. engine oil or exhaust gas temperatures sufficiently high and engine running.



Note:

In addition, automatic regeneration is not possible with the engine idling or running at an elevated idling speed. It cannot finish without a good period of actual driving because this is the only time in which the necessary temperatures are reached in the exhaust gas aftertreatment system.



Note:

If regeneration is in progress and one of the operating conditions is subsequently no longer fulfilled, the green indicator lamp  goes out prematurely and regeneration is aborted.



Note:

It restarts automatically when all necessary operating conditions are fulfilled again. Interrupting the drive while the green “Particulate filter” indicator lamp  is lit will prolong the duration of regeneration.

Inhibiting automatic regeneration of the diesel particulate filter

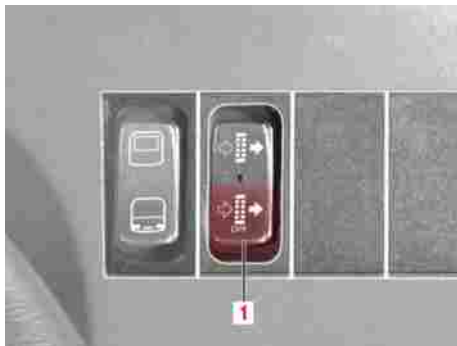

M54.00-2235-71

If the elevated exhaust gas temperatures associated with regeneration may present a danger, e.g. where the heat produced may jeopardise safety, it is possible to inhibit the regeneration process. Neither automatic nor manual regeneration can then be initiated and regeneration is stopped if it is already in progress.

Press the lower section of pushbutton (1).



Note:

The LED in the “Inhibit regeneration” pushbutton comes on and no regeneration can be started.



Caution:

Leave the regeneration inhibitor activated only for as long as the danger exists. Whenever you activate the regeneration inhibitor, regeneration will continue to be inhibited even after the next engine start. There would otherwise be a risk of rapid loading of the diesel particulate filter.

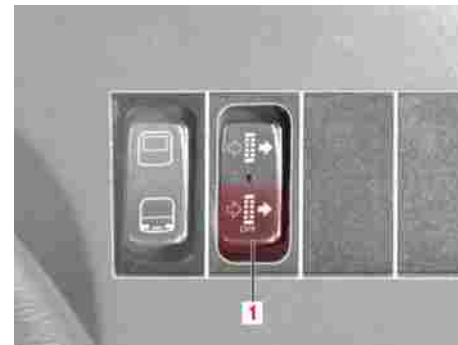

M54.00-2235-71

To deactivate, press the lower section of inhibit pushbutton (1) again.



Note:

The LED in the pushbutton goes out.

Catalytic converter protection function

In very rare cases (e.g. frequent low load operation with relatively low exhaust temperatures), there is a possibility of unburnt fuel collecting in the exhaust system. The exhaust system could suffer damage as a result.

Starting regeneration of the diesel particulate filter manually (parked regeneration)

To prevent this, the engine speed is automatically increased for approximately 20 to 30 minutes by the exhaust gas aftertreatment control module under specific circumstances. This raises the exhaust temperature and burns off the fuel.



Note:

This function cannot be started unless the vehicle is parked (parking brake applied) and the engine is idling.



Note:

A corresponding message appears on the display screen to indicate that the catalytic converter protection function is active.



Note:

It is possible to interrupt this function by switching off the engine, engaging a gear or releasing the parking brake.

Starting regeneration of the diesel particulate filter manually (parked regeneration)

- ▶ Pull over safely with regard for other traffic and leave the engine running. Park well clear of other vehicles, objects and all flammable materials.



Danger.

Very hot exhaust fumes are expelled from the exhaust tail pipe during the manual regeneration process (parked regeneration). Keep well clear of the exhaust tail pipe. Otherwise, you could be burned by the fumes.



Caution:

Manual regeneration must be carried out only in the open air or in rooms with good ventilation. The use of an extraction system should be avoided because this will generally not have been designed to withstand the exhaust temperature levels that arise.



Caution:

Make sure that no highly flammable materials, e.g. dry grass or fuels, come into contact with the exhaust system during the manual regeneration process (parked regeneration). Do not leave the bus parked up at a filling station, on dry grass or on harvested crop fields. The hot exhaust system could otherwise cause the highly flammable material to ignite and set the bus on fire.



Note:

Under normal circumstances, automatic regeneration of the diesel particulate filter is sufficient to avoid heavy soot loading of the filter. However, if the bus is predominantly driven short distances or with the engine under low load, it might not be possible for automatic regeneration to finish successfully.

Starting regeneration of the diesel particulate filter manually (parked regeneration)



Note:

If the diesel particulate filter load state becomes critical, a yellow indicator lamp  lights up in the instrument cluster. A pop-up window appears on the display screen prompting you to start regeneration of the diesel particulate filter. The manual regeneration process lasts approximately 30 to no more than 60 minutes.

- ▶ Apply the parking brake.
- ▶ Shift the transmission to neutral N.
- ▶ Take your foot off the accelerator pedal.
- ▶ If active, deactivate the regeneration inhibitor.



Note:

refer to “Inhibiting automatic regeneration of the diesel particulate filter”.

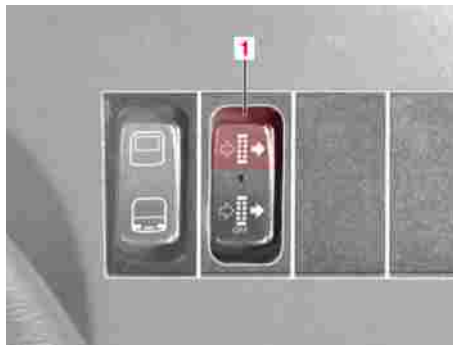

M54.00-2234-71

- ▶ Press and hold the upper section of “Manual regeneration” pushbutton (1) for approximately 3 seconds.



Note:

Manual regeneration cannot be started unless the engine oil and exhaust gas temperatures are sufficiently high, the AdBlue® is not frozen and the system is functioning normally.

The green indicator lamp  in the instrument cluster comes on and engine speed is increased.

When regeneration has finished, the green indicator lamp  in the instrument cluster goes out and engine speed drops to idling speed.



Note:

Regeneration will be aborted automatically if you deselect transmission neutral position, release the parking brake or activate the regeneration inhibitor by pressing the lower section of the “Regeneration inhibitor” pushbutton.



Note:

Engine speed drops to idling speed if the process is aborted.



Note:

Regeneration cannot be started unless all necessary operating conditions have been fulfilled, e.g. engine oil or exhaust gas temperatures sufficiently high. If the on-board computer prompts manual regeneration at low outside temperatures, start the regeneration process before the

Operating/malfunction displays: fuel system/exhaust gas cleaning system

vehicle is parked. If you were to park the vehicle without initiating regeneration, you would not be able to start the regeneration process manually until after a subsequent engine warm-up phase. If you were to park the vehicle without initiating regeneration and the AdBlue® were frozen, you would not be able to start the regeneration process manually until after a thawing period of up to 60 minutes.

Operating/malfunction displays: fuel system/exhaust gas cleaning system

Fuel reserve



Fuel level has reached the reserve level.

AdBlue® level



If the level in the AdBlue® supply tank falls to the reserve level, this icon appears on the screen and a yellow warning level malfunction alert is displayed to remind the driver that an AdBlue® top-up is due.

Exhaust cleaning malfunction / fault in the exhaust gas cleaning system



The MIL (malfunction indicator lamp) lights up in the event of a malfunction in the exhaust gas cleaning system (SCR system). The MIL flashes in the event of a fault in the exhaust gas cleaning system (display if permissible NOx values exceeded) or if the AdBlue® supply tank runs empty. If the malfunction alert was triggered by the AdBlue® supply tank running empty, it is necessary to top up the AdBlue® level immediately. If the AdBlue® supply tank has run empty, the driver must have actively acknowledged the AdBlue® level operating display (see left) at some time previously.

Operating/malfunction displays: fuel system/exhaust gas cleaning system



Note:

The indicator lamp is located in the instrument cluster.



Danger.

Have a malfunction/NOx fault rectified immediately by an OMNIplus Service Partner.

Engine power output reduction



In the event of a NOx fault (display if permissible NOx concentration exceeded), engine torque will be reduced the next time the bus moves off from stationary. In this situation, a fault is also present in the exhaust gas cleaning system, i.e. the MIL flashes. If the fault was caused by the AdBlue® supply tank running empty, the AdBlue® level operating display is also displayed. The

AdBlue® supply tank must be filled immediately.



Danger.

Have NOx faults rectified immediately by an OMNIplus Service Partner.

Automatic increase in idling speed



To avoid a power shortage in the on-board power supply/network, 3 measures are successively implemented, 1. Increase in idling speed, 2. Power reduction of individual consumers, 3. Deactivation of consumers.

Diesel particulate filter (DPF) operating notifications



Displayed if the exhaust counterpressure of the diesel particulate filter (DPF) exceeds a defined limit value.



Note:

The icon is accompanied by the message “Werkstatt aufsuchen” (Visit workshop) in the form of a yellow warning level malfunction display.

Operating 230/400 V systems (option)

Operating 230/400 V systems (option)

Special safety precautions must be taken when operating 230/400 V systems; these will be described below:



Danger.

Maintenance and repair work may only be carried out by personnel who have undergone the appropriate special training.

▷ The system manufacturer's safety and operating information must be observed without fail.



Danger.

Residual current devices fitted in the bus must be function-tested at regular intervals.

The following safety precautions are an absolute requirement if the 230/400 V system is to be supplied by an outside feed:



Note:

Check any extension lead used for damage before plugging it in.



Note:

The networks to which the 230/400 V system is connected must have protection in the form of a residual current device. Otherwise, plug in an external RCD as an adapter.



Note:

Check the correct operation of this RCD by pressing the test button. Only then should you connect the 230/400 V system of the bus to the mains supply.

Function description: accident data recorder (ADR) (option)



Note:

The accident data recorder (ADR) is a system for detecting and recording accidents and driving events, e.g. pulling away against a kerb or sudden braking.



Note:

The accident data recorder (ADR) is activated automatically when the ignition is switched on.



Note:

The accident data recorder (ADR) remains active for 3 days after the ignition has been switched off and continues to register all vehicle movements (e.g. parking collisions).

Function description: accident data recorder (ADR) (option)



M54_00-1502-71

- ▶ Switch on the ignition.

The accident data recorder (ADR) carries out a self-test and provides audible notification of the current operating status or the presence of a hardware fault.

i **Note:**

A brief, one-off audible signal (buzzer in the control panel) (4) indicates that the accident data recorder (ADR) is ready for operation.

i **Note:**

Indicator lamp (2) lighting up and a brief, one-off buzzing sound means that at least one event is stored.

i **Note:**

A sequence of four long buzzes indicates that the accident data recorder (ADR) has detected a parking collision. Check your vehicle for damage.

i **Note:**

Eight short buzzes mean that the memory of the accident data recorder (ADR) is almost full to capacity. Export the events and have the memory cleared.

i **Note:**

Ten short buzzes mean that the accident data recorder (ADR) has malfunctioned. Similarly, a malfunction is present if no signal sounds.

- ▶ Following any critical traffic or accident situation, it is possible to record an entry manually.

i **Note:**

When pushbutton (1) is pressed following an accident, the event (approximately 43 seconds before, during and after the accident) is stored and remains write-protected for an extended period.

Anti-jackknifing protection during forward travel

Anti-jackknifing protection during forward travel

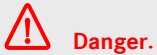

Risk of accident. If the rear car begins to swing from side to side, the bus must be stabilised by braking. If a malfunction occurs in the anti-jackknifing protection system (red warning lamp in conjunction with the “Anti-jackknifing protection” symbol), it is permissible to drive the bus as far as the nearest workshop but only in exceptional cases, in favourable weather conditions (non-skid road surface) and at a speed of no more than 12 mph (20 km/h). In all other cases the bus must be towed.



If a malfunction occurs in the anti-jackknifing system, indicated by the red warning lamp in conjunction with the “Anti-jackknifing system malfunction” malfunction display, the vehicle will be braked automatically down to a speed of 30 mph (50 km/h).

- ▶ If the bus articulation angle and steering angle are divergent during forward travel, the anti-jackknifing protection responds as follows.

The buzzer sounds.

Anti-jackknifing protection is activated.

- ▶ If the driver countersteers in this situation, the anti-jackknifing protection responds as follows:

Anti-jackknifing protection is deactivated.

The following indication display on the display screen goes out: “Anti-jackknifing protection active” (A).



M54.00-2292-71

The following appears on the display screen: “Anti-jackknifing protection active” (A).

Anti-jackknifing protection during reverse travel

Anti-jackknifing protection during reverse travel

- ▶ If the bus articulation turns to a specific angle and reaches a specific speed during reverse travel, the anti-jackknifing protection responds as follows:

The buzzer sounds.

The accelerator pedal is locked.

Anti-jackknifing protection is activated.

The bus stop brake is activated.



M54.00-2292-71

The following appears on the display screen: “Anti-jackknifing protection active” (A) “Bus stop brake active” (B).

- ▶ If, in this situation, the driver countersteers or selects a transmission drive range from “1” to “D”, the anti-jackknifing protection responds as follows:

Anti-jackknifing protection is deactivated.

The following indication display on the display screen goes out: “Anti-

jackknifing protection active” (A), “Bus stop brake active” (B).

The bus can now be moved forwards again.

i Note:

If a speed of approximately 6 mph (10 km/h) is exceeded when the bus is being reversed in a straight line, operation of the accelerator pedal will be restricted automatically. This prevents further acceleration. If a higher speed is reached despite this measure, the bus stop brake will be activated. As soon as the speed of travel falls below 5 mph (9 km/h), the bus stop brake will be released and accelerator pedal operation will no longer be restricted.

Passenger stop request

Passenger stop request



Note:

Precondition: Electrical system on, doors closed.



M72_00-0037-01

- ▶ Passenger stop request: Press push-button (1).

A signal sounds.



M82_00-0005-01

“Bus stopping” or “Stop” (2) on the passenger information screen lights up.



The following appears on the display screen: “Stop request”.



Note:

The “Bus stopping” or “Stop” passenger information and the “Stop request” indication display on the display screen go out when a door is opened.

Ramp request



Note:

Precondition: Electrical system on.



M72_00-0038-01

- ▶ Passenger: Press pushbutton (1).
A signal sounds.



M82_00-0005-01

“Bus stopping” or “Stop” (2) on the passenger information screen lights up.

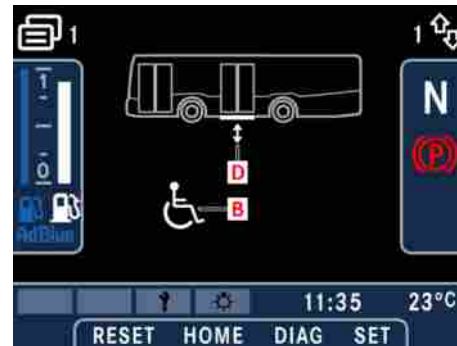

M54.00-2296-71

“Wheelchair” symbol (B) is displayed on the display screen.



Note:

The “Bus stopping” or “Stop” passenger information goes out when a door is opened.

Safety instructions for the operation of mechanically folding/electric ramps (options)



Note:

If a ramp is fitted, the “Wheelchair” symbol goes out after the door with the ramp has closed.

Safety instructions for the operation of mechanically folding/electric ramps (options)



Danger.

Park the bus in such a way that there can be no possible risk to the person being transported, to the operator or to other road users while the ramp is in operation.



Danger.

The parking brake must be applied.



Danger.

Do not exceed the maximum permissible height span.



Danger.

Do not fold the ramp out or in (extend or retract it) if anyone is within the ramp's range of movement. Do not subject the ramp to load while it is in motion.



Danger.

Observe the maximum payload.



Note:

Before the ramp is used, it must be checked to ensure that it is fit for use, serviceable and undamaged.



Note:

In the front doorway of buses equipped with a lift, no passengers are permitted to remain in the area up to the hinged barrier while the vehicle is in motion.

▷ For notes on safety and operation, also refer to the manufacturer's operating instructions.

Folding the ramp in/out



Note:

Precondition: Bus stationary, parking brake applied, door open.



Caution:

Observe operating notices and load-bearing capacity plates (max. 350 kg).

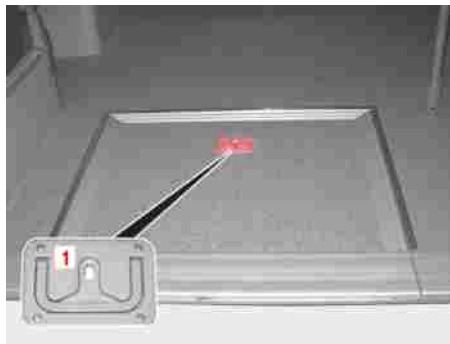

M72.00-0516-71

- ▶ Lift the ramp from outside by handle (1).



Note:

It is no longer possible to operate the door with the ramp folded out.



Danger.

The bus must not be moved while the ramp is in the folded-out position.

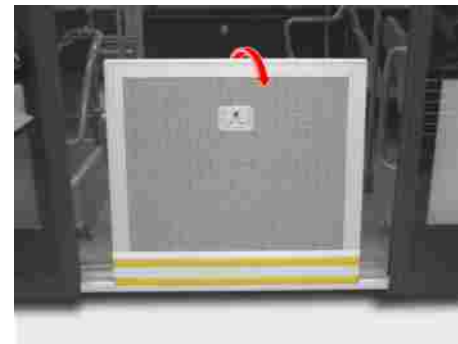

M72.00-0517-71

- ▶ Fold the ramp upwards and hold it.



Caution:

The ramp plate could tip.



Caution:

Risk of entrapment for fingers and hands.

Folding the ramp in/out



M72.00-0518-71

- ▶ Lower the ramp until it is resting on the ground.



Note:

The ramp must be resting flat on the ground and parallel with the bus.



M54.00-2293-71

“Ramp folded out” (C) appears on the display screen.



In addition, a red indicator lamp lights up in the instrument cluster.

- ▶ The ramp is folded back in in reverse order.

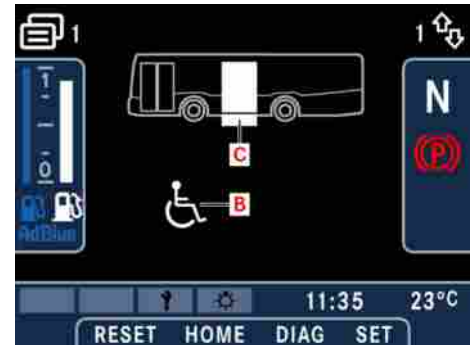

M54.00-2293-71

“Ramp folded out” indication display (C) goes out.



Note:

“Wheelchair” symbol (B) goes out after the door with the ramp has closed.



The red indicator lamp in the instrument cluster goes out.

Retracting/extending the electric ramp (option)

- ▶ Ramp malfunction.

i **Note:**

A malfunction is displayed on the display screen if the ramp has not been folded in fully but the door is closed.



M54.00-2294-71

Malfunction display (S).

Retracting/extending the electric ramp (option)

i **Note:**

Precondition: Bus stationary, door closed, bus stop brake active.

i **Note:**

Observe operating notices and load-bearing capacity plates (max. 350 kg).



M54.00-2270-71

- ▶ Ignition starter switch to position 2

Retracting/extending the electric ramp (option)



M54.00-2369-71

- ▶ Press and hold the lower section of pushbutton (1).



Note:

Door operation is disabled while the ramp is being retracted/extended.



Danger.

The bus must not be moved while the ramp is in the extended position.

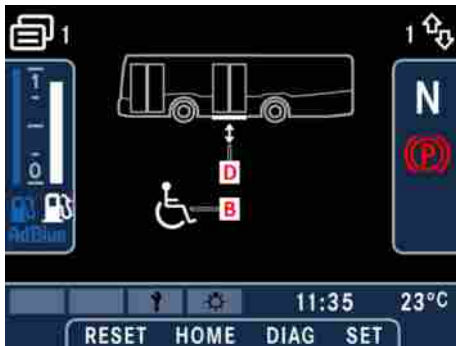

M54.00-2296-71

The display screen shows (D) “Ramp in use”, and flashing arrows signal that the ramp is in motion.



Note:

“Wheelchair” symbol (B) is displayed when the ramp has been requested.



Caution:

It must be ensured that there is no possibility of persons being injured and of objects being damaged while the ramp is retracting/extending.

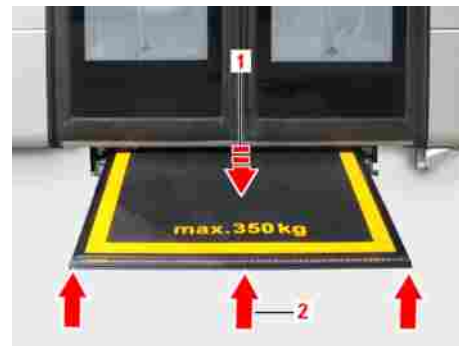

M54.00-2370-71

- ▶ Tread sensor (1): If the tread plate is subjected to a load of more than 15 kg while retracting/extending is in progress, the tread plate will stop moving. The respective movement will be resumed as soon as the tread plate is relieved of this load.

Retracting/extending the electric ramp (option)



Note:

The ramp also features an audible and visual warning function.

Impact edge sensor (2): If the tread plate strikes an obstacle while it is extending, it will stop moving and retract.



Danger.

The ramp must not be used if there is a technical defect.



Note:

To extend the ramp, it is necessary to press pushbutton (1) again.



M54.00-2295-71

Screen display for ramp (C) fully extended.



Note:

The door can be opened.



In addition, a red indicator lamp lights up in the instrument cluster.

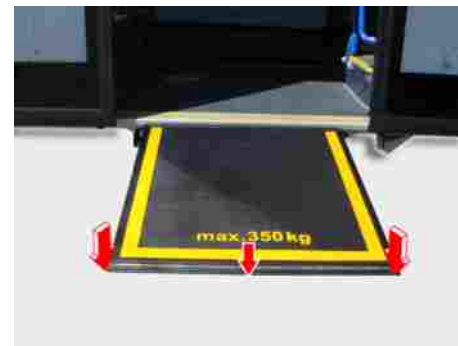

M54.00-2371-71



Note:

The tread plate must be resting flat on the ground and parallel with the bus.

► Retract the ramp.



Note:

The way in which the ramp is operated may vary, depending on the customer's specification.

Press the “Close door” door pushbutton (ramp retracts).

Retracting/extending the electric ramp (option)



M54.00-2296-71

The display screen shows “Ramp in use” (D), and flashing arrows signal that the ramp is in motion.



Note:

“Wheelchair” indication display (B) goes out after the ramp has been retracted.



M54.00-2293-71

“Ramp extended” indication display (C) goes out.



The red indicator lamp in the instrument cluster goes out.



M54.00-2369-71



Note:

With the door closed and the ramp extended, it is possible to retract the ramp by briefly pressing the upper section of pushbutton (1).

Opening the hinged window

► Ramp malfunction



Note:

A malfunction is displayed on the display screen if the ramp has not been extended/retracted fully but the door is closed.



M54.00-2294-71

Malfunction display (S).



Note:

In an emergency, the tread plate can be pushed in/out manually. However, this task must be carried out only by qualified, expert personnel.



Caution:

Risk of entrapment for fingers and hands.

Opening the hinged window



M67_00-0012-01

- Open the window inwards using the handle.

Air circulates in the passenger compartment without the need for a fan when the hinged windows and roof hatches are open.

Care and cleaning

Care and cleaning



Note:

Observe the laws and regulations in all countries concerned.



Danger.

Risk of injury. Whenever work is carried out on the bus, all applicable safety regulations must be observed (e.g. operating instructions, environmental laws and regulations, occupational safety and accident prevention regulations, etc.).



Danger.

Risk of poisoning. Observe the instructions for use of the care and cleaning products.



Danger.

Risk of poisoning. Always keep care and cleaning products sealed and out of the reach of children.



Danger.

Risk of poisoning. Diesel, regular and premium-grade fuels are harmful to health. They should not be used as a cleaning product.



Danger.

Risk of fire. Diesel, regular and premium-grade fuels are highly flammable. They should not be used as a cleaning product.



Danger.

Do not use round-spray jets to clean tyres or suspension air bags. The pulsating jet of water could cause concealed damage to the tyre substructure or suspension air bags. This damage would not become

apparent until much later and could cause the tyre or suspension air bag to burst. You could then lose control of your bus and cause an accident, which could result in injury to yourself and others.



Caution:

Do not work with high-pressure cleaners or steam cleaners in the region of axle seals (e.g. hubs, drive flange) and axle breathers. In automatic vehicle washes, make sure that these areas will not be severely subjected to jets of water.



Caution:

We recommend that only tested and approved care products should be used. Information about acceptable care products can be obtained from your OMNIplus Service Partner.



Caution:

For cleaning work in the engine compartment, the use of cleaning agents containing acetone or chloroethylene is prohibited.



Caution:

If you are using a steam cleaner to perform cleaning work in the engine compartment, do not aim the jet directly at belt tensioners or idler pulleys.



Caution:

Stone chips and impurities, especially insect remains, bird droppings, tree resins, oils and greases, fuels and tar stains, should be remedied immediately with the use of approved care products.



Caution:

The bus must be cleaned more frequently in winter to remove salt residues from road gritting.



Environmental protection

Dispose of empty containers, cleaning cloths and polishing wads in an environmentally responsible manner.

Tilting a rear seat



Note:

The rear seats can be tilted forwards to permit cleaning of the rear area.



M54.00-2285-71

- ▶ Push back (1).
- ▶ Disengage clasp (2) by hand.

Tilting the seat row on the transmission cover

- ▶ Tilt seat (3) forwards.



Caution:

Risk of entrapment for fingers and hands.



Note:

After cleaning, fold the seat back and engage it.

Tilting the seat row on the transmission cover

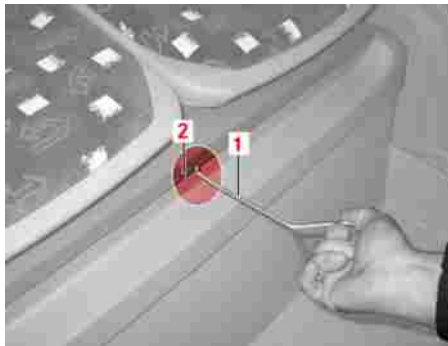

M00.01-0012-71

- ▶ Insert hook spanner (1) into opening (2).

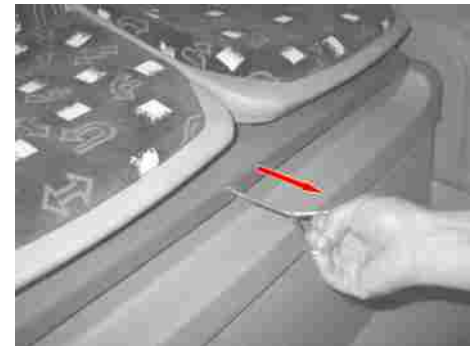

M00.01-0014-71

- ▶ Engage the hook spanner in the locking mechanism.
- ▶ Pull the hook spanner in the direction of the arrow.

Care and cleaning of covers and upholstery



M00.01-0013-71

- ▶ Fold the seat row forwards.



Caution:

Risk of entrapment for fingers and hands.

Care and cleaning of covers and upholstery

Special notes on care and cleaning of covers and upholstery



Note:

Observe the instructions on your upholstery fittings and covers in the detailed description of the bus.



Caution:

Do not use cleaning products containing solvents (e.g. cleaning benzine, acetone, alcohol, etc.). This would damage covers and equipment parts made of plastic or foam beyond repair.



Caution:

Only use pH neutral care and cleaning agents to avoid bleaching out the colours.



Care/cleaning of fabric covers



Danger.

Observe the general information/safety precautions in this section.



Note:

Regular care and basic cleaning help to maintain the value and high-quality appearance of fabric covers. For this reason, carry out basic cleaning regularly. Carry out basic cleaning more regularly if necessary, depending on use and the level of dirt.

Basic cleaning - weekly

- ▶ Vacuum the covers thoroughly along the nap of the fabric.

Care/cleaning of fabric covers



Caution:

Do not use rubber vacuum nozzles or rubber attachments. These could pull threads out of the upholstered covers.

- ▶ Using a soft brush, brush the fabric along the nap.

Basic cleaning - every six months

- ▶ First carry out the weekly basic cleaning.
- ▶ Work up a foam from a mild, luke-warm soap solution (e.g. from a mild-action detergent).
- ▶ Apply the foam evenly over all the covers using a soft, slightly damp sponge.
- ▶ Wait until the freshly cleaned covers are completely dry.



Caution:

The covers must be completely dry before they are sat on again. Permanent pressure marks could otherwise form.

- ▶ Brush along the nap of the fabric using a soft brush, without applying pressure.

Removing stains



Caution:

Remove dirt as soon as possible to prevent permanent stains or damage to the covers.

- ▶ Remove as much dirt as possible using a lint-free cloth.
- ▶ Using a soft sponge, work a mild, lukewarm soap solution into the dirt in circular movements from the outside in. Apply light pressure when doing this.



Note:

Always clean up the dirt from the outside in to prevent it from being dispersed in the fabric.

- ▶ Mop up the soap solution using a clean, soft sponge.
- ▶ Wait until the freshly cleaned areas are completely dry.



Caution:

The covers must be completely dry before they are sat on again. Permanent pressure marks could otherwise form.

- ▶ Finally, brush the cover and the cleaned areas using a soft brush along the nap of the fabric.

Malfunction displays: Yellow warning level - description



Caution:

If in any doubt, use a professional textile cleaning company.

Malfunction displays: Yellow warning level - description



M54.00-2290-71

Yellow warning level malfunctions appear on the display screen as status indicator (3).



Caution:

In the event of a yellow warning level malfunction, it is permissible to drive on carefully but the bus should be checked by an OMNIplus Service Partner at the earliest opportunity.

Screen sequence

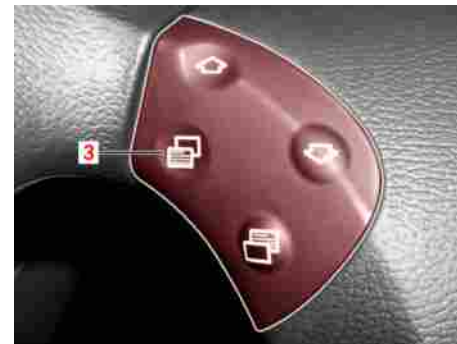

M68.00-0430-71

Yellow warning level malfunction displays have to be acknowledged by the driver pressing pushbutton (3).

Malfunction display: Red warning level

Screen sequence



M54.00-2297-71

When the malfunction is acknowledged, the pop-up window with the yellow alert closes and the “Message available” symbol (1) appears on the display screen



Note:

“Message available” symbol (1) on the display screen indicates that it is possible to call up a message (malfunction, maintenance due) from a system.



Caution:

In the event of a yellow warning level malfunction, it is permissible to drive on carefully but the bus should be checked by an OMNIplus Service Partner at the earliest opportunity.

Malfunction display: Red warning level



M54.00-2298-71

Red warning level malfunctions are indicated instantly as they occur by an audible warning signal and red status indication (1) on the display screen. A pop-up window also appears. The display remains active until the malfunction has been rectified. It is not possible to clear the malfunction display or switch to a different display mode.

Malfunction display: Red warning level

**Danger.**

Risk of accident. In the event of a red warning level malfunction, the operating safety or roadworthiness of the bus is at risk. The driving and braking characteristics of the bus may change. The bus must be stopped immediately (traffic conditions permitting) and an OMNIplus Service Partner must be notified.

▷ For further information about red warning level malfunctions, please refer to the Operating Instructions.

Triggering of the fire extinguishing system



M54.00-2299-71

The triggering of the fire extinguishing system (e.g. due to a fire in the engine compartment) is indicated by a symbol (1) in conjunction with the malfunction text “Feuer Motorraum” (Engine compartment fire) on the display screen.

**Danger.**

Risk of accident. If this alert is displayed, bring the vehicle to an immediate halt (road and traffic conditions permitting), open all the doors and urge the passengers to disembark. Then operate the master safety switch and apply the parking brake (refer to Operating Instructions). Disembark and implement or arrange further measures as necessary.

**Danger.**

Keep the engine compartment flap closed for at least 5 minutes after a triggering of the fire extinguishing system.

**Note:**

This malfunction triggers a “red warning level” malfunction display.

Overview of vehicle key	86
Driver's area overview	88
Switches on the left section of the instrument panel	89
Switches on the right section of the instrument panel	91
Driver's area side compartment	94
Instrument cluster	98
MTCO tachograph	102
DTCO tachograph	104
Tachograph	105
Tachograph approval seal	106
Location of emergency equipment	106
Windscreen washer fluid reservoir installation location	108

Overview of vehicle key

Overview of vehicle key



- 1 Key for the ignition switch
- 2 Key for: Doors, interior and exterior flaps
- 3 Key for (option): Doors, interior and exterior flaps
- 4 Key for key switch: Lowering system, ramp, disabled passengers' lift

Driver's area overview

Driver's area overview

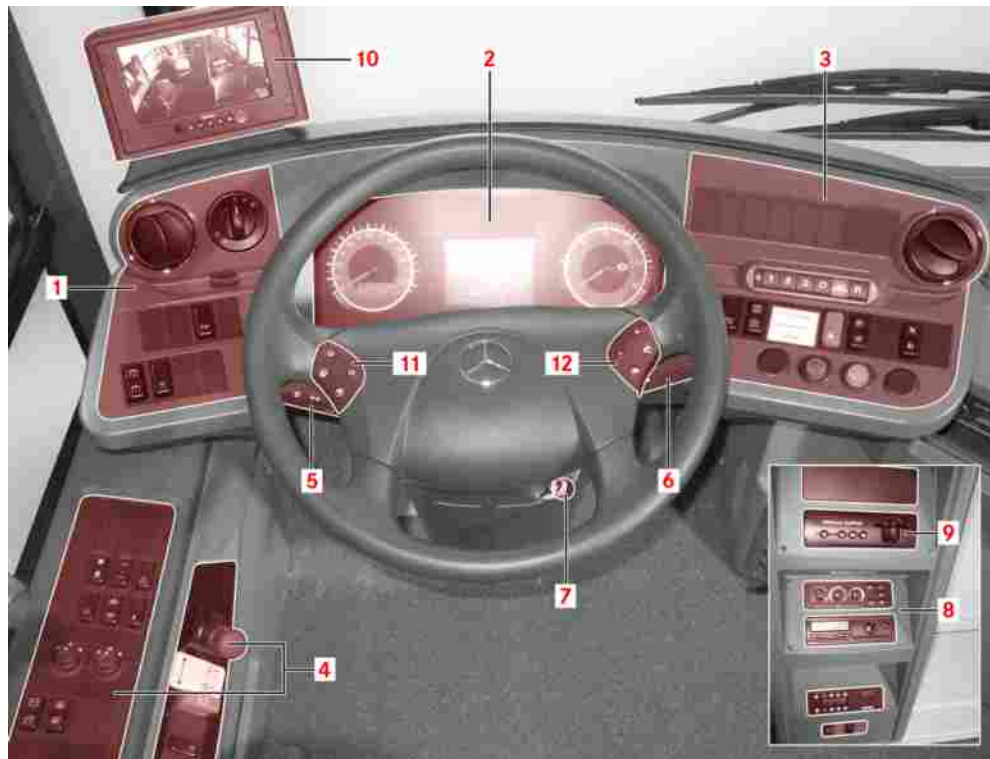

Switches on the left section of the instrument panel

No.	Description	Page
1	Switches on the left section of the instrument panel	89
2	Instrument cluster	98
3	Switches on the right section of the instrument panel	91
4	Driver's area side compartment	94
5	Steering column switch for light and wiper functions	
6	Combination switch for retarder and cruise control (option)	114
7	Ignition starter switch	118
8	DTCO tachograph	104

No.	Description	Page
8	MTCO tachograph	102
9	Driver's area/passenger compartment audio system control panel	
10	Driver's area (option)	
11	Left-hand steering wheel buttons	
12	Right-hand steering wheel buttons	

Switches on the left section of the instrument panel

**Note:**

The overview shows the maximum utilisation of the instrument panel with switches and instruments in their designated position. To accommodate the customisation requirements of the customer, the switches may have been assigned to different positions on the instrument panel.

Switches on the left section of the instrument panel



Switches on the right section of the instrument panel

No.	Description	Page
1	Driver's area (option)	
2	Rotary light switch	112
3	Switch for deactivating pedal-activated continuous braking	
4	Direct retarder on/off switch	
5	ESP OFF pushbutton (Electronic Stability Program)	
5	ASR (acceleration skid control) OFF pushbutton	
6	Bus stop steering limiter pushbutton	
7	Passenger-compartment lighting switch positions I+II	

No.	Description	Page
8	Payment tray lighting switch	
9	Overhead lighting dimmer switch	
10	Passenger compartment night lighting switch	
10	Pushbutton for raising the bus above normal level	

Switches on the right section of the instrument panel

**Note:**

The overview shows the maximum utilisation of the instrument panel with switches and instruments in their designated position. To accommodate the customisation requirements of the customer, the switches may have been assigned to different positions on the instrument panel.

Switches on the right section of the instrument panel

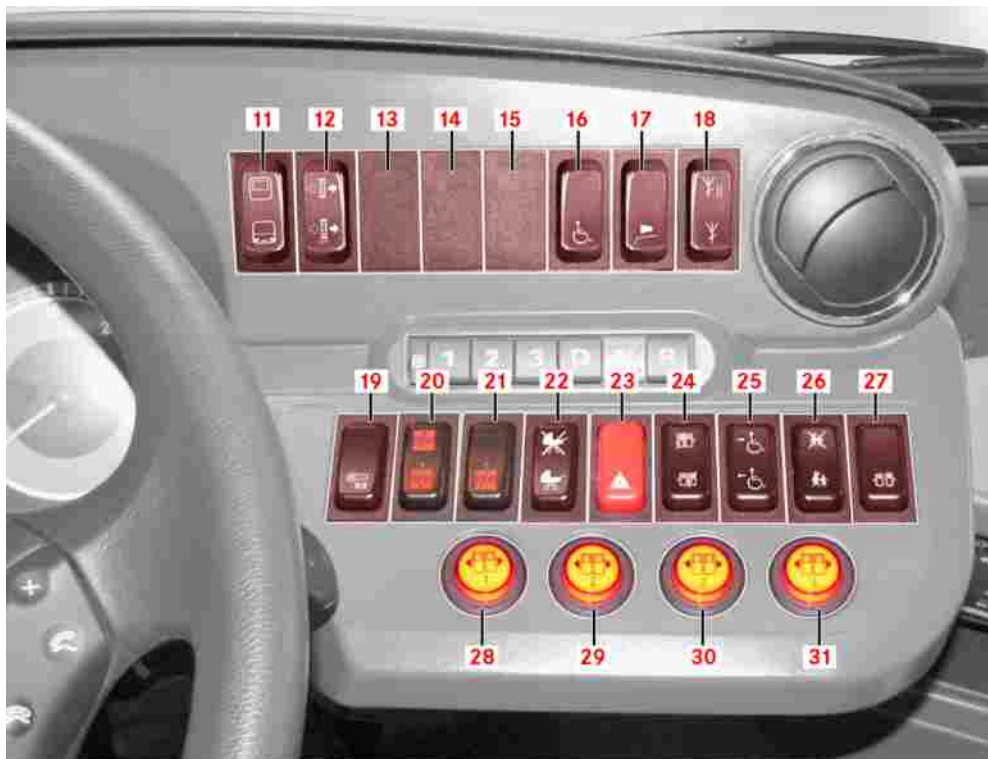

Switches on the right section of the instrument panel

No.	Description	Page
11	Display pushbutton - to browse the upper and lower areas of the display screen separately	
12	DPF cleaning switch (diesel particulate filter)	
13	Not assigned	
14	Not assigned	
15	Not assigned	
16	Ramp enabling switch	
17	Exterior loud-speaker on/off switch	
18	Communications radio 1/2 switch	
19	Bus stop brake pushbutton	

No.	Description	Page
20	Pushbutton for lowering the bus on the entry side	
21	Raise bus pushbutton	
22	Switch for holding the automatic doors open for pushchairs	
23	Hazard warning lamps switch	
24	Pushbutton for disabling the door leaves at all doors	
24	Switch for disabling the rear door leaf at door 1	
25	Mobility lift up/down pushbutton	

No.	Description	Page
26	School bus mode switch	
27	Door enabling switch	
28	Pushbutton for opening/closing the doors from the inside	
29	Pushbutton for opening/closing door 1	
30	Pushbutton for opening/closing door 2	
31	Pushbutton for opening/closing door 3	

Driver's area side compartment

Driver's area side compartment



Note:

The arrangement of the switches and other controls may differ, depending on customer specifications.

Driver's area side compartment



Driver's area side compartment

No.	Description	Page
1	Driver's window open/close pushbutton	
2	Roller sunblind up/down pushbutton	
3	Not assigned	
4	Cool box pushbutton	
5	Exterior mirror adjustment rotary switch	
6	Rear-view mirror adjustment rotary switch	
7	Speed limiter switch	
8	Driver's window heating/mirror heating pushbutton	

No.	Description	Page
9	Monitoring system switch	
9	Pushbutton for raising the bus above normal level	
10	Camera switching pushbutton	
10	Driving ride height 2 pushbutton	
11	"Pull-away aid on/off" switch	
12	Pushbutton for manual/automatic fans	
13	Pushbutton for roof hatches in air-out position, open/close	
14	Emergency valve reset pushbutton (rapid air charging)	

No.	Description	Page
15	"Centre trailing axle" switch	
16	Air horn switch	
17	Exterior loud-speaker on/off switch	
17	Electrical system on/off switch	
18	Engine start/stop pushbutton	
19	Heating/ventilation/air-conditioning control panel - driver's area	196
20	Auxiliary heating preset timer (option)	
21	Ignition starter switch	118
22	Bus lowering key switch	

Instrument cluster

No.	Description	Page
23	Master safety switch (emergency-off switch)	119
24	Failsafe mode emergency switch (Voith transmission only)	
25	Steering column adjustment switch	
26	Master safety switch	
26	Accident data recorder (ADR) switch	
27	Drive-off lock emergency release switch	
28	Parking brake operating lever	

Instrument cluster



Note:

The symbol displays in the instrument cluster may differ, depending on the customer's specification.



Danger.

Risk of accident. Stop immediately (traffic conditions permitting) if red warning lamp (5) lights up. The driving and braking characteristics of the bus may change. Notify an OMNIplus Service Partner.



Caution:

If yellow warning lamp (6) lights up, it is permissible to drive on carefully but the bus should be checked by an OMNIplus Service Partner at the earliest opportunity.



Note:

If a malfunction occurs in the anti-jackknifing system, indicated by the red warning lamp in conjunction with the "Anti-jackknifing system malfunction" malfunction display, the vehicle will be braked automatically down to a speed of 50 km/h.



No.	Description	Page
1	Indicator lamp for the left-hand turn signals	
2	Flaps indicator lamp	
3	Communications radio indicator lamp	
4	Headlamp flasher/main-beam indicator lamp	
5	Dipped-beam indicator lamp	
6	Not assigned	
7	Not assigned	
8	Stop request	
9	Stop request operated	
10	Door position indicator lamp	

No.	Description	Page
11	Stop request	
12	Indicator lamp for the right-hand turn signals	
13	Tyre pressure indicator lamp	
14	Ticket-cancelling machine indicator lamp	
15	DPF regeneration indicator lamp	
16	Level control indicator	
17	Bus stop brake indicator	
18	ESP indicator lamp	
19	Brake system malfunction indicator lamp	

No.	Description	Page
20	Ramp indicator lamp	
21	Ramp request indicator	
22	Stop request	
23	Screen (display)	
24	Tachograph warning lamp	
25	Emission-relevant fault malfunction display (MIL)	
26	Exhaust gas cleaning system (SCR system) malfunction display	
27	To reset the trip meter	
28	Dimmer button	
29	Button functions vary with screen display	

MTCO tachograph

MTCO tachograph

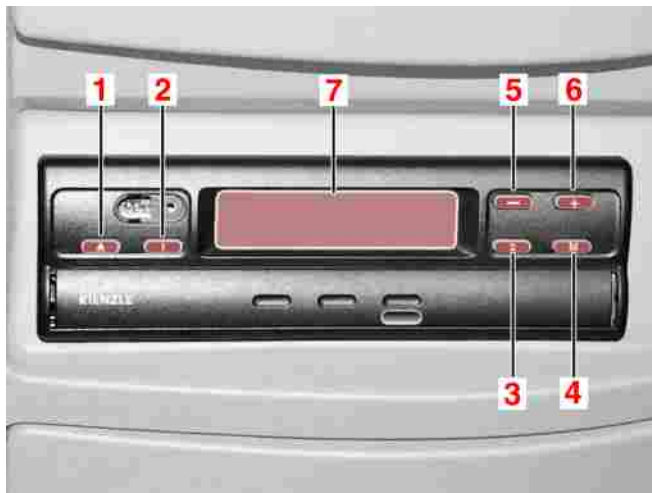

- 1 Button for opening the recording sheet tray: Driver 1 inserts his labelled recording sheet into the recording sheet tray and on top of the partition plate with the front side of the sheet facing upwards. Driver 2 inserts his labelled recording sheet into the recording sheet tray and underneath the partition plate with the front side of the sheet facing upwards. The recording sheets must be swapped over whenever the drivers change over.
- 2 Button for setting the required time group for driver 1: Press and hold the button until the required time group appears on the display screen.
- 3 Button for setting the required time group for driver 2: Press and hold the button until the required time group appears on the display screen.
- 4 Menu selection button (clock adjustment, fault indication, etc.): The time can be changed as desired. Summer and winter time has been programmed for several years in advance and the changeover takes place automatically.
- 5 Button (-): : Moving back within the menu
- 6 Button (+): : Moving forwards within the menu
- 7 Display screen (illuminated when ignition starter switch ON): The basic display (date, time and total distance) appears if there are no fault alerts. Flashing display screen = the time on the recording sheet tray does not correspond to the time on the display screen (e.g. after a voltage supply interruption or changeover from summer to winter time). The time is set automatically: remove the recording sheets and close the recording sheet tray without the recording sheets in it.
 - ▷ Observe the manufacturer's operating instructions.

DTCO tachograph

DTCO tachograph

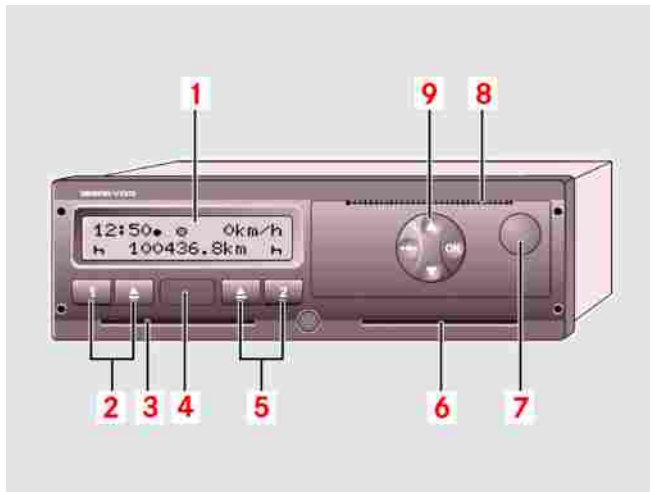

1 Display screen: Screen displays vary according to the operating state of the bus.

▷ refer to “Display variants” in the manufacturer's operating instructions.

2 Key panel, driver 1



Note:

Activity button, driver 1/card slot ejector button, driver 1

3 Card slot, driver 1: Driver 1, the current driver of the bus, inserts his driver card into card slot 1.

4 Download/calibration interface: There is an interface under the cover. This interface cannot be enabled without an inserted company card, control card or workshop card.

▷ For details, refer to “Access rights for tachograph cards” in the manufacturer's operating instructions.

5 Key panel, driver 2



Note:

Activity button, driver 2/card slot ejector button, driver 2

6 Card slot, driver 2: Driver 2, who is not currently driving the bus, inserts his driver card into card slot 2.

7 Printer drawer release button: This button is used to release the printer drawer, for example, for inserting a new roll of paper.

8 Tear-off edge

9 Menu buttons: Buttons for entering, displaying or printing data.

▷ Refer to “Calling up menu functions” in the manufacturer's operating instructions.

Tachograph

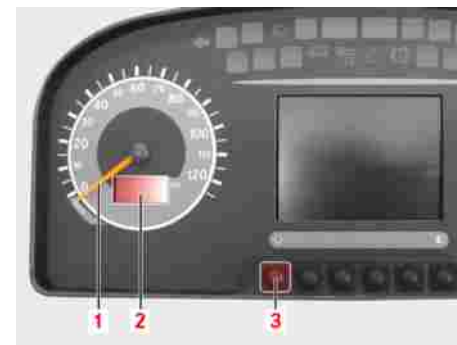

M54.00-1793-71

1 Speed display

2 Display field for total distance recorder/trip meter

3 To reset the trip meter

Press and hold to reset the trip meter to 0.

Tachograph approval seal



M00.01-0010-71

1 Tachograph approval seal (country-specific)

Statement on the compliant installation, condition, accuracy and operating principle of the tachograph.

Location of emergency equipment



Note:

The laws and regulations of the country in which the bus is operated must be observed.



Note:

The equipment is marked in the specified language.



Note:

The markings may differ in colour, design and content, depending on the legislation and specification in the countries concerned.



M86.00-0434-71

- ▶ In an emergency: Break open the flap upwards.

The emergency equipment compartment to the right of the driver contains: 2 first-aid kits, 1 warning triangle, 1 warning lamp, 1 high-visibility jacket, 1 torch.

Location of emergency equipment

**Note:**

Use the key to open emergency equipment compartment (1) in normal circumstances (e.g. to inspect and correct the contents).

**Note:**

The laws and regulations of the country in which the bus is operated must be observed.

- Fire extinguisher (1) is protected by a cover. Pull this off in an emergency.



M86_00-0046-01

- Open snap lock (2) and lift out fire extinguisher (1).

Fire extinguisher (1) is ready for operation (observe operating instructions on the fire extinguisher).

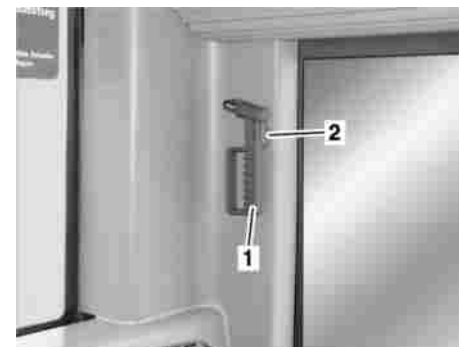

M86_00-0047-01

- Release emergency hammer (1) (tamper-evident seal) and remove it from bracket (2).

The emergency hammer is ready for use.

Windscreen washer fluid reservoir installation location

Windscreen washer fluid reservoir installation location

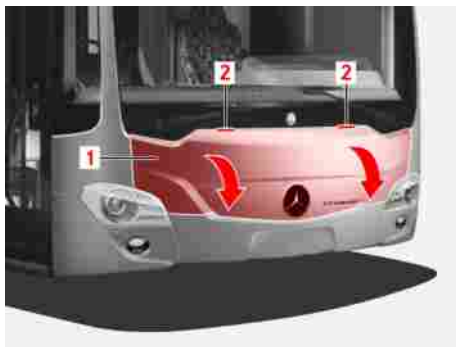

M88.00-0100-71

- ▶ Open the front flap (to open front flap (1), hold it by handle recesses (2) with both hands and pull).

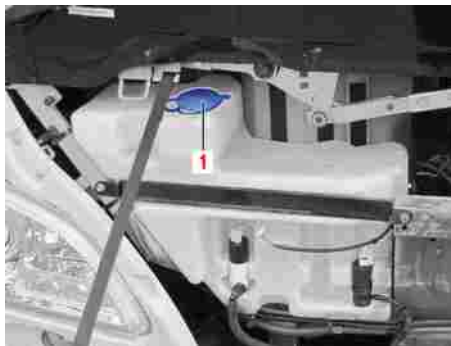

M86.00-0435-71

Windscreen washer fluid reservoir (1) is located near the headlamp on the right-hand side.

Rotary light switch	112
Left steering column switch: Light and signal functions	113
Left steering column switch: Wiper and wash functions	113
Combination switch for retarder and cruise control (option)	114
Ignition starter switch	118
Parking brake	118
Master safety switch (emergency-off switch)	119
Overview of steering wheel buttons and display screen	122
Display screen	124
Display screen (description)	125
Permanent displays	126
Trailer turn signals	127
Overview of main menus and submenus	128
Menu structure	129
Display screen menu control logic	136
Event notifications	138

Table of contents

Overview of the operating, function and malfunction display screen	140
Instrument cluster "button assignment"	146
Resetting the trip meter	147
Trip computer data manual reset	148
HOME button	149
Menu button	150
DIAG button (on-board diagnostics)	150
SET button	151
Setting the language	152
Adjusting the volume of the turn signal buzzer	154
Adjusting the display brightness (daytime brightness)	155
Adjusting the display brightness (night brightness)	156
Right-hand steering wheel buttons	158
Left-hand steering wheel buttons	160
Vehicle manoeuvrability with the air suspension depressurised	161
Lowering/raising the bus on the boarding side	162

Raising the bus above normal level	164
Activating/deactivating the pull-away aid	166
Applying the parking brake	167
Releasing the parking brake	168
Emergency braking in the event of failure of both brake circuits	169
Activating/deactivating the bus stop brake	170
Drive-off lock	171
Important information on the steering system	172
Adjusting the steering wheel	173
Turning the steering wheel when the bus is stationary	174
Opening/closing the driver's window	175
Switching the mirror and window heating on and off	176

Rotary light switch

Rotary light switch

combines the following functions:

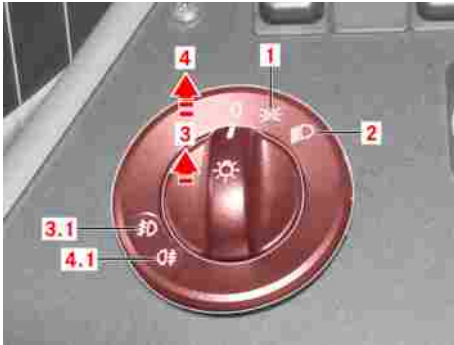

M54_00-1248-71

- 0 Switched off.
- 1 Side lamps.
- 2 Headlamps: Dipped-beam headlamps/main-beam headlamps (depending on the steering column switch position) with the ignition starter switch in position 2 (drive position).



Note:

In countries where traffic drives on the other side of the road to that in the country where the vehicle was registered, there is a risk of oncoming traffic being dazzled by the asymmetrical dipped-beam headlamps. Observe local rules and regulations when driving in these countries (mask headlamps if necessary).

- 3 Front foglamps (pull switch, first position). In addition to the side lamps, dipped-beam headlamps or main-beam headlamps if the ignition starter switch has been switched to ON. Indicator lamp (3.1) in the rotary light switch lights up.
- 4 Rear foglamp (pull switch, second position). In addition to the front foglamps. Indicator lamp (4.1) in the rotary light switch lights up. When a trailer or skibox is connected, the rear foglamp on the towing vehicle is disabled and only the rear foglamp connected via the trailer socket is enabled.

Left steering column switch: Light and signal functions

Left steering column switch: Light and signal functions



M54_00-1326-71

- 1 Horn: Press button.
- 2 Indicate left and right with automatic reset: Push the switch stalk beyond the pressure point until it clicks into position.
- 3 Lane change: Push the switch stalk to the pressure point, hold it there and release it - the switch stalk returns to the centre position.

- 4 Headlamp flasher: Pull the switch stalk towards the steering wheel as far as the pressure point.
- 5 Main-beam and dipped-beam headlamps: Switch stalk in basic position = dipped-beam headlamps / pull the switch stalk towards the steering wheel beyond the pressure point = main-beam headlamps.

Left steering column switch: Wiper and wash functions



M54_00-1327-71

- 6 Windscreen wipers: Turn the sleeve on the switch stalk: speed 0 = off, speed INT = intermittent, speed I = normal, speed II = rapid.



Note:

The roof hatches close automatically when the windscreen wipers are switched on.

Combination switch for retarder and cruise control (option)

- 7 Wipe and wash: Press the sleeve on the steering column switch towards the steering column: With windscreen wipers switched off = windscreen wipe and wash.

Combination switch for retarder and cruise control (option)

Drive cruise control

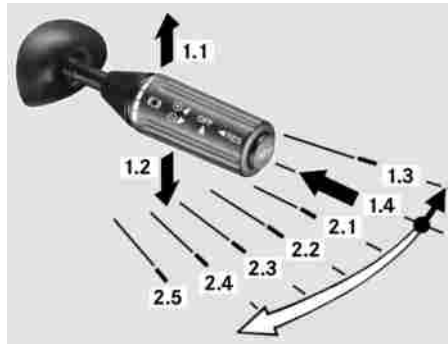

M54_00-0976-01

To activate drive cruise control: Pre-condition: Bus travelling faster than 15 km/h. The service brake pedal must be fully released and the continuous brakes must not be active.

- 1.1 Tap briefly (< 0.5 seconds) = current driving speed is set and appears on the display screen. Tap briefly again (< 0.5 seconds) = set speed increased in increments of 0.5 km/h. Press and hold (> 0.5 seconds) = bus speed increased until switch released. When the combination switch is released, the current speed is set as the new value.
- 1.2 Tap briefly (< 0.5 seconds) = current driving speed is set and appears on the display screen, or resumption of last stored speed. Tap briefly again (< 0.5 seconds) = set speed reduced in increments of 0.5 km/h. Press and hold (> 0.5 seconds) = bus speed reduced until switch released. When the combination switch is released, the current speed is set as the new value.

Combination switch for retarder and cruise control (option)

- 1.3 Cruise control is deactivated and the last stored speed is retained by the control unit.



Note:

Drive cruise control is deactivated automatically as soon as the service brakes or continuous brakes are operated or the neutral button is pressed.



Danger.

Do not use cruise control on a slippery road surface - there is a risk of skidding. Do not use cruise control unless road and traffic conditions permit a constant speed to be maintained.



Note:

On steep uphill or downhill gradients, it may not be possible for a constant speed to be maintained.

Variable speed limiter

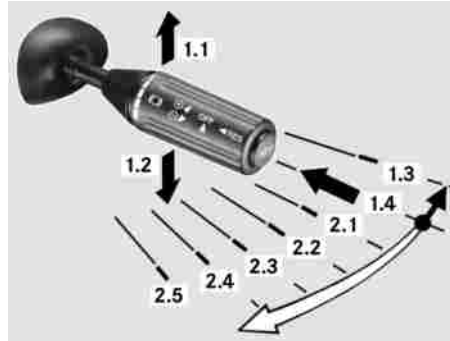

M54_00-0976-01

- 1.4 Tap briefly = speed limiter (LIM): The current speed is set as the maximum speed. The set speed is shown on the display screen. The driver has to continue to use the accelerator pedal. Press and hold: The set limit speed will continue to be increased until the control is released. To deactivate: Move combination switch to position 1.3 or activate cruise control.



Note:

The speed limiter can be activated at speeds above 10 km/h; between 10 km/h and 15 km/h it is always limited to 15 km/h. It is possible to override the set speed temporarily by depressing the accelerator pedal beyond the stop (kickdown).

Continuous brakes

To activate the continuous brakes:

- 2.1- Retarder stage 1 - 5 active
- 2.5



Danger.

Do not activate the continuous brake (retarder) on a slippery road surface. The wheels could lock - risk of skidding.

Combination switch for retarder and cruise control (option)



Danger.

If the accelerator pedal is operated while the continuous brakes are active, the continuous brakes will be deactivated and the braking effect will be cancelled.



Caution:

Only ever move the combination switch through one stage at a time when attempting to achieve the necessary braking torque (do not jerk it directly to the required position). Except in an emergency, it is prohibited to force the combination switch directly to the required position in one action. However, it is acceptable to skip several stages at once if you are reducing the braking torque. For the optimum braking torque to be achieved, the engine should be turning within its upper speed range so that the coolant does not overheat.

Brake cruise control

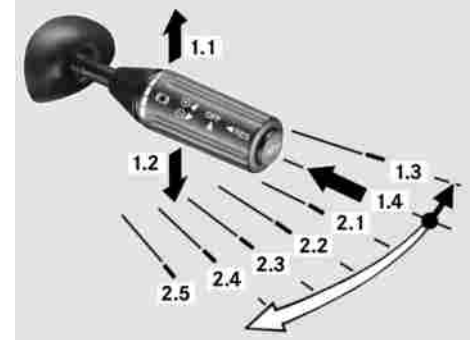

M54_00-0976-01

The retarder maintains the speed of the bus at the set cruising speed to the extent that the retarder's maximum braking torque is sufficient for this to remain possible. To activate brake cruise control: Precondition: Retarder stage 1 - 5 (position 2.1 - 2.5) activated. Accelerator pedal and brake pedal fully released.

Combination switch for retarder and cruise control (option)

- 1.1 Tap briefly (< 0.5 seconds) = current driving speed is set and appears on the display screen. Tap briefly again (< 0.5 seconds) = set speed increased in increments of 0.5 km/h. Press and hold (> 0.5 seconds) = set speed increased until switch released. When the combination switch is released, the current speed is set as the new value.
- 1.2 Tap briefly (< 0.5 seconds) = current driving speed is set and appears on the display screen. Tap briefly again (< 0.5 seconds) = set speed reduced in increments of 0.5 km/h. Press and hold (> 0.5 seconds) = set speed reduced until switch released. When the combination switch is released, the current speed is set as the new value.

Combined cruise control

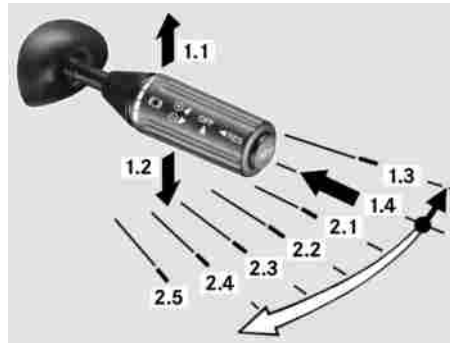

M54_00-0976-01

To activate combined cruise control: Set drive cruise control and press in button 1.4 on the combination switch at the same time: The current speed (e.g. 88 km/h) is set as the cruising speed and shown on the display screen, and brake cruise control is automatically set to a value that is 4 km/h higher than the cruising speed (i.e. 92 km/h). The system switches between modes of operation automatically as required. The display on the display screen changes to one value or the other depending

on the mode of operation. Alternatively: Set brake cruise control and press knob 1.4 on the combination switch in at the same time: The current speed (e.g. 100 km/h) is set as the limit speed and shown on the display screen, and drive cruise control is automatically set to a value that is 4 km/h lower than the limit speed (i.e. 96 km/h). The system switches between modes of operation automatically as required. The display on the display screen changes to one value or the other depending on the mode of operation.

Engine speed increase

Precondition: Bus stationary, engine running.

- 1.1 The engine speed can be increased up to a maximum of 750 rpm.
- 1.3 Engine speed increase off, normal idling speed

Ignition starter switch

Ignition starter switch

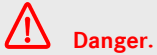

Danger.

Never lock the steering while the bus is in motion. Whenever you disembark, even for a short time, always remove the key so that the bus cannot be started by children or other unauthorised persons.

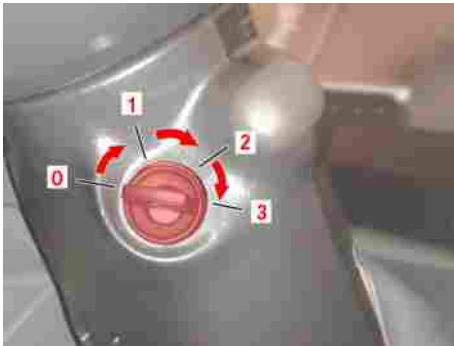

M54.00-2270-71

- 0 Rest position: Insert or remove the key in this position; the side lamps can be switched on.

- 1 Steering unlocked: All consumers can be switched on.
- 2 Drive position.
- 3 Start position.

Parking brake

Parking brake valve.



Caution:

The parking brake spring brake cylinders require a release pressure of 5.8 to 6.4 bar. At low supply pressures, there is a risk that the brake may not be fully released, that the friction pads may make slight contact while the bus is in motion and that the brake may be subjected to unnecessarily high thermal loads. When the parking brake is released, the corresponding icon on the screen must go out. If the compressed-air system for the parking brake is damaged, it is possible to release the parking brake using the emergency release device.



Caution:

Do not apply the parking brake unless the bus is stationary.

Master safety switch (emergency-off switch)



Danger.

Always apply the parking brake before you leave the driver's area.



Danger.

Check the hand lever for full engagement.

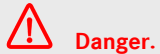

Danger.

With the parking brake applied, ABS can no longer perform its intended function.

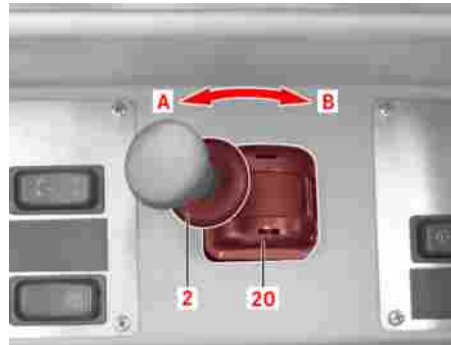

M42_00-0657-71

▷ For notes on safety and operation, refer to the “Driver's area controls” section of the Operating Instructions.

Master safety switch (emergency-off switch)

When master safety switch (1) is operated, the engine is switched off if running and the power supply to the vehicle electrical system is interrupted. The hazard warning lamps remain functional. The emergency-off switch is operated by opening the cover and pulling out the yellow knob.



Danger.

Risk of accident. The emergency-off switch should not be operated except in an emergency and only with the bus stationary - never while the bus is in motion. Operating the emergency-off switch causes the engine to switch off automatically. The power steering would consequently be disabled if the bus were in motion. Additional effort would then be required in order to steer. Furthermore, the power supply to all important electrical consumers (e.g. bus lighting, ABS, electronic transmission shift system, etc.) would be interrupted. The roadworthiness of the bus is at risk.

Master safety switch (emergency-off switch)



Note:

Additional functions may be available, depending on the national variant.



Note:

In Poland, the hazard warning lamps are switched on automatically.



Note:

In Finland, Greece, Spain and Italy, the hazard warning lamps and interior lighting are switched on automatically. The central locking is enabled (ECE-R 36).



Note:

In Austria, operating the emergency-off switch switches off the engine and interrupts the supply of power to the entire electrical system.



Note:

In France, the hazard warning lamps are enabled.



Note:

In Norway, the hazard warning lamps, interior lighting, auxiliary heating and horn are ready for operation.



M54_00-1309-71

Driver's area controls

Overview of steering wheel buttons and display screen

Overview of steering wheel buttons and display screen

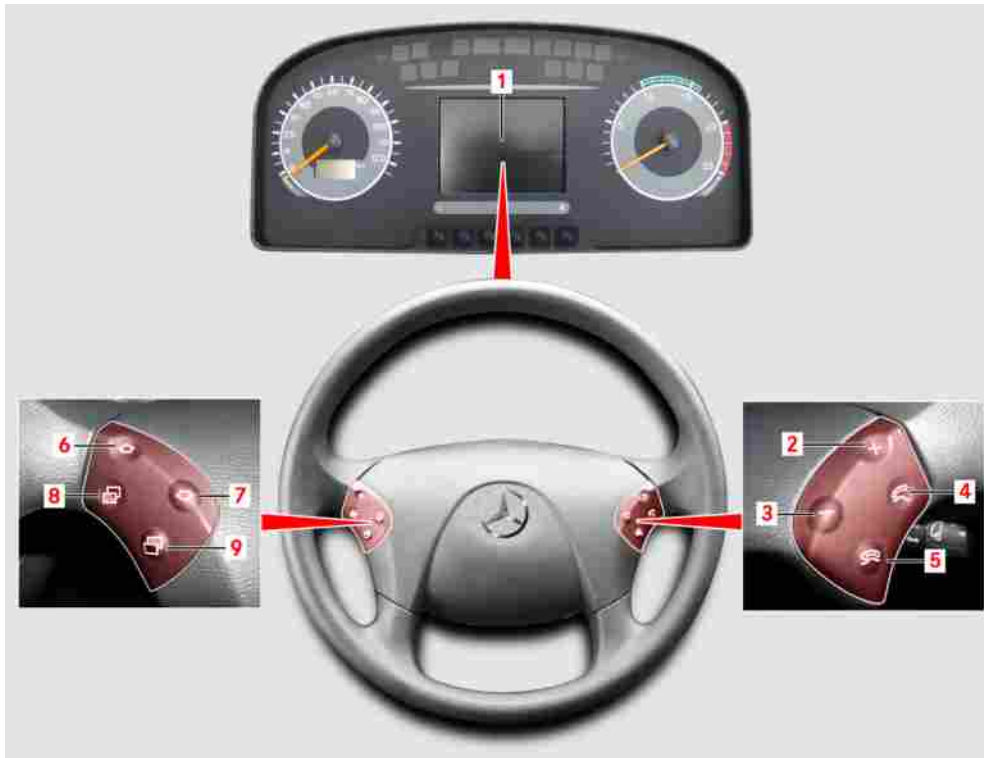

Overview of steering wheel buttons and display screen

1	Display screen		<i>To go to the next main menu</i>
2	Plus key		<i>up</i>
	<i>To adjust the volume of the turn signal buzzer</i>		<i>To close a pop-up window</i>
	<i>To adjust the display brightness</i>	9	Back main menu button
			<i>To go to the next main menu down</i>
3	Minus key		<i>To close a pop-up window</i>
	<i>To adjust the volume of the turn signal buzzer</i>		
	<i>To adjust the display brightness</i>		
4	To pick up the telephone		
	<i>Not assigned</i>		
5	To hang up the telephone		
	<i>Not assigned</i>		
6	Next arrow button		
	<i>To go to the next submenu up</i>		
	<i>To move up a line in a list</i>		
7	Back arrow button		
	<i>To go to the next submenu down</i>		
	<i>To move down a line in a list</i>		
8	Next main menu button		

Display screen

Display screen

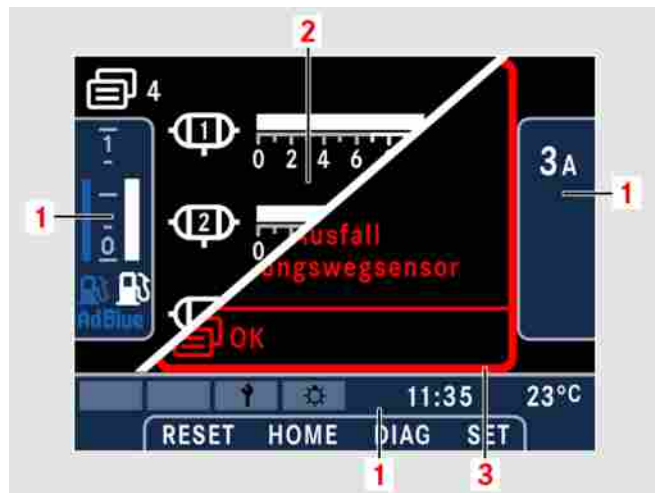

The display screen comprises three basic elements:

1

Permanent display fields



Note:

The permanent display fields contain important operating displays and status information for the driver. The display field at the lower edge of the display screen is visible at all times, while the display fields on the left- and right-hand side are hidden when the image from the reversing camera is displayed.

2

Menu system



Note:

The menu system is designed exclusively for viewing information.

3

Pop-up windows



Note:

Pop-up windows are used for changing settings, for displaying events and driver input feedback and for carrying out on-board diagnostics.

Display screen (description)

The display screen is active at all times while the ignition starter switch is switched to ON. The display screen is also activated when the following functions are used: side lamps/hazard warning lamps/interior lighting/door opened from outside. The display screen is a status indicator for showing operating and malfunction information. Additionally, it can be used to display on-board diagnostics information.



Note:

If a malfunction occurs, it will be displayed only if the ignition starter switch is in position 2.

Permanent displays

Permanent displays

Permanent display, left-hand side



M54.00-2301-71

The permanent display field on the left-hand side contains the fuel gauge. The fuel gauge comprises two vertical bar graphs. Left bar graph (2) shows the fill level in the AdBlue® tank, right bar graph (1) shows the fill level in the diesel tank.

Permanent display, right-hand side



M54.00-2302-71

The permanent display field on the right-hand side contains gear indicator (1), brake indicator (2) and driving characteristics (3): Gear indicator (1) shows the selected gear. Brake indicator (2) represents the braking functions of the bus. As different functions compete for the same symbol position, only the most important braking function is displayed at any one time. A white symbol indicates active braking, grey is used for an inactive or preselected brake (example: retarder preselected). Field (3) represents

conditions that may affect the driving characteristics of the bus. As different functions compete for the same symbol position, only the most important function is displayed at any one time.

Permanent display, lower



M54.00-2303-71

The upper area of the lower permanent display is used to display various status indicators (red alert, yellow alert, service notification) (2). The time (3) and outside temperature (4) in °C are also shown in this field. - °C is displayed if an error occurs in the transmission of data to the temperature display. The

lower area of lower permanent display field (1) shows the current function of the buttons in the instrument cluster.

**Note:**

The lower permanent display field may vary, depending on the customer's specification



M54.00-2304-71

Trailer turn signals (1) on the display screen flash at the same frequency as the turn signals.

Overview of main menus and submenus

Overview of main menus and submenus

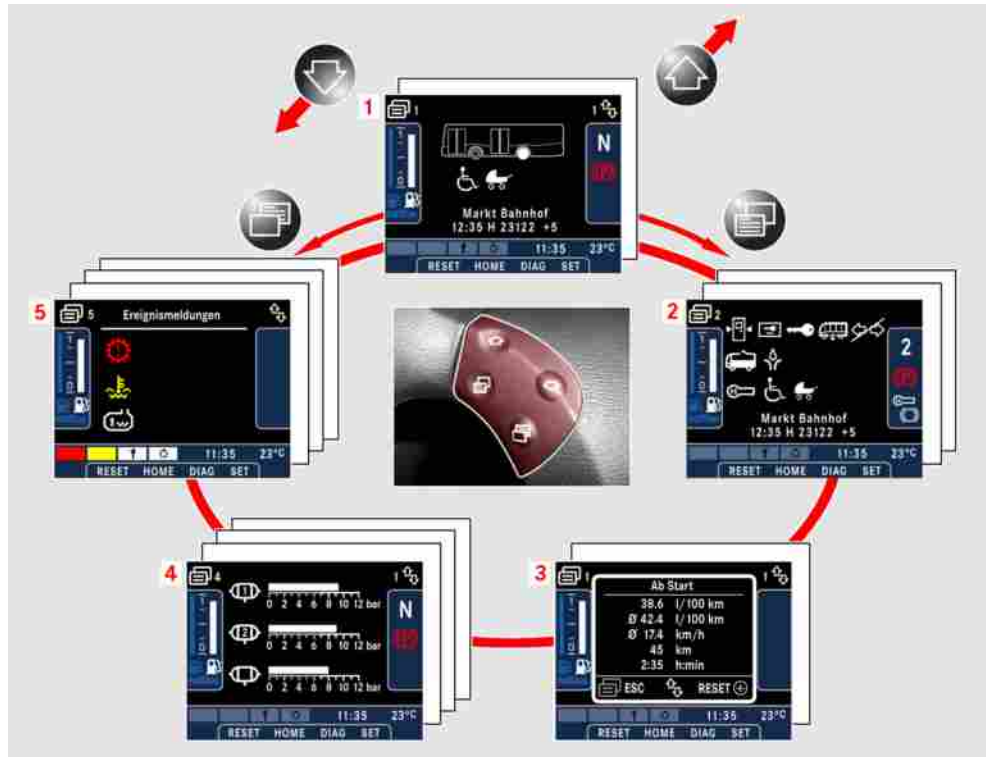

- 1 "Fahrzeug" (Vehicle) main menu
 - 1.1 *Doors and flaps*
 - 1.2 *Reversing camera/door camera/interior camera*
 - 1.3 *Door camera/interior camera*
 - 1.4 *Door camera/interior camera*
- 2 "Assistenz" (Assistance) main menu
 - 2.1 *Operating notifications*
 - 2.2 *Driver assistance menu (customer specification)*
- 3 "Reiserechner" (Trip computer) main menu
 - 3.1 *After start*
 - 3.2 *After reset*
- 4 "Kontrolle" (Monitoring) main menu
 - 4.1 *Pressures*
 - 4.2 *Oil*
 - 4.3 *Temperature*
 - 4.4 *Voltage*
- 5 "Ereignisse" (Events) main menu
 - 5.1 *Overview*

5.2 *Individual events*



Note:

This overview takes all possible items of optional equipment into account. Bus-specific menu structures may differ from bus to bus.

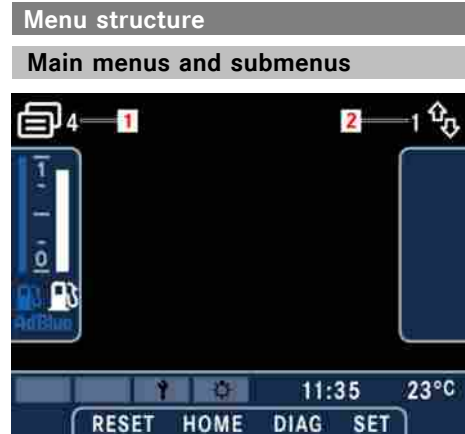

M54.00-2306-71

The menu system comprises five main menus arranged in a loop. The driver is able to browse from menu to menu using the main menu buttons on the steering wheel. For orientation purposes, the number (1) of the current main menu is displayed at the top left of the display window. Each main menu contains a series of submenus, which are also arranged in a loop. The number (2) identifying the submenu concerned is shown in the top right of the display. The only

Menu structure

menu in which this principle does not apply is the “Ereignisse” (Events) main menu, where the submenus are not numbered because the quantity of event notifications is continually changing.



Note:

When the “Next” main menu button is pressed briefly, the display advances to the next higher main menu. If the screen is showing the main menu with the highest number when the button is pressed, the display will return to the main menu with the lowest number (looped main menu structure).



Note:

When the “Back” main menu button is pressed briefly, the display goes back to the previous main menu. If the screen is showing the main menu with the lowest number when the button is pressed, the display will return to the main menu with the highest number.



Note:

When the “Next” arrow button is pressed briefly, the display advances to the next higher submenu. If the screen is showing the submenu with the highest number when the button is pressed, the display will return to the submenu with the lowest number (looped submenu structure).



Note:

When the “Back” main menu button is pressed briefly, the display goes back to the previous submenu. If the screen is showing the submenu with the lowest number when the button is pressed, the display will return to the submenu with the highest number.



Note:

After an ignition power cycle, the first submenu in the sequence will be displayed the first time a main menu is called up. As soon as the driver selects a different submenu, this submenu will be remembered by the system if the driver

changes to a different main menu, i.e. the submenu last viewed in a particular main menu will be displayed immediately the next time the driver changes back to this main menu. In this way, the driver could select one submenu within each main menu to be a favourite so that, whenever the main menu buttons are pressed, the display would change from one favourite to another.

1. “Fahrzeug” (Vehicle) main menu

The “Fahrzeug” (Vehicle) main menu displays the status of all doors, flaps and roof hatches. It also enables the driver to view the images transmitted by any cameras fitted in bus.

“Türen und Klappen” (Doors and flaps) submenu



M54.00-2307-71

Closed doors, flaps and ramps are greyed out, while opened ones appear in white. The statuses of the engine compartment flap and roof hatches are also displayed. If the parking brake is applied, the wheel on the driven axle appears in white.



Note:

For operating/malfunction displays, refer to the “Opening/locking” section.

“Kamera” (Camera) submenu



M54.00-2308-71

The bus may be fitted with cameras that enable the driver to monitor door 2 and the area behind the bus. The images from each of these cameras are displayed in their own submenu.



Note:

If a reversing camera is installed, the image from the reversing camera appears on the display screen automatically when the driver engages reverse gear. The permanent display fields on the left- and right-hand sides of the screen are hidden by the camera image. Only the lower permanent display field remains visible.



Note:

The image from the door 2 camera appears on the display screen only when the driver opens door 2.

“Assistenz” (Assistance) main menu

In the “Assistenz” (Assistance) main menu, the driver can view all available information relating to operating notifications and driving systems (customer specification).

Menu structure

“Betriebsmeldungen” (Operating notifications) submenu



M54.00-2309-71

Selected, important operating notifications are displayed in their own submenu rather than in the lower permanent display field. These notifications do not necessarily need to be brought to the driver's attention. If, however, the driver would like to view information about the condition of a specific vehicle system, it is possible for the driver to call up these operating notifications by selecting this menu.



Note:

The majority of the operating notifications in this submenu relate to the heating, ventilation and air-conditioning system.

3. “Reiserechner” (Trip computer) main menu

The trip computer calculates the driving time, distance covered, average speed and average fuel consumption.

“Ab Start” (After start) submenu

The “Ab Start” (After start) trip computer data are reset automatically whenever the ignition remains switched off for longer than four hours.



Note:

A manual reset is also possible, refer to the “Driver's area controls” section of the Operating Instructions: “RESET button - resetting trip computer data”.

“Ab Reset” (After reset) submenu

The “Ab Reset” (After reset) trip computer data continue to be incremented until they are reset manually by the driver.



Note:

Refer to the “Driver's area controls” section of the Operating Instructions: “RESET button - resetting trip computer data”.

4. “Kontrolle” (Monitoring) main menu

In the “Kontrolle” (Monitoring) main menu, the driver can view information about pressures, fill levels, temperatures, etc., supplied by various systems of the vehicle. Selected, important operating notifications are also displayed in this menu.

"Drücke" (Pressures) submenu



M54.00-2361-71

The respective supply pressure (0 to 12.0 bar) for circuit 1 (driven axle) circuit 2 (front axle) and circuit 3 auxiliary consumers (0-9.0 bar) are displayed. The white areas of the scales highlight the acceptable pressure range during normal vehicle operation. The grey areas of the scales indicate critical pressure values of below 6.8 bar for circuits 1 and 2 and below 5.5 bar for circuit 3. A malfunction alert is issued whenever a pressure reaches a critical value. The pressure value can be viewed in the monitoring menu after the malfunction alert has

been acknowledged. The symbol and the bar graph for the compressed-air circuit concerned are coloured yellow or red, depending on how critical the malfunction alert is.

**Danger.**

In the event of a red warning level malfunction, the bus must be stopped immediately (traffic conditions permitting) and an OMNIplus Service Partner must be notified.

**Caution:**

In the event of a yellow warning level malfunction, it is permissible to drive on carefully but the bus should be checked by an OMNIplus Service Partner at the earliest opportunity.

"Öl" (Oil) submenu (option)



M54.00-2311-71

The "Öl" (Oil) submenu displays engine oil level (1). If a critical value is reached, the symbol turns yellow or red.

**Danger.**

In the event of a red warning level malfunction, the bus must be stopped immediately (traffic conditions permitting) and an OMNIplus Service Partner must be notified.

Menu structure



Caution:

In the event of a yellow warning level malfunction, it is permissible to drive on carefully but the bus should be checked by an OMNIplus Service Partner at the earliest opportunity.



Note:

A negative value (-) for the engine oil level indicates that the oil level needs to be topped up (refer to the "Practical advice" section of the Operating Instructions - Engine oil level display)

"Temperatur" (Temperature) submenu

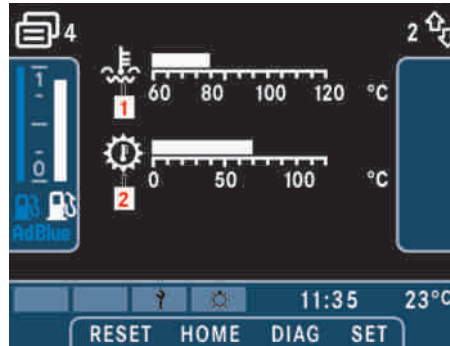

M54.00-2312-71

The "Temperatur" (Temperature) submenu displays coolant temperature (1) and transmission oil temperature (2). The white areas of the scales indicate the values to be expected during normal operation. If a critical value is reached, the associated symbol and bar graph turn yellow or red.



Danger.

In the event of a red warning level malfunction, the bus must be stopped immediately (traffic conditions permitting) and an OMNIplus Service Partner must be notified.



Caution:

In the event of a yellow warning level malfunction, it is permissible to drive on carefully but the bus should be checked by an OMNIplus Service Partner at the earliest opportunity.



Note:

The coolant temperature should be approximately 85 °C when the engine has warmed up to normal operating temperature.

“Spannung” (Voltage) submenu



M54.00-2313-71

The on-board voltage is displayed in this separate submenu.



Note:

The battery voltage display should show 25 - 28 V when the engine is running. If this is not the case, you should visit an OMNIplus Service Partner as a matter of urgency.

“Reifen” (Tyres) submenu (option)



M54.00-2314-71

The “Reifen” (Tyres) submenu displays the pressure of each tyre (2) and the battery charge of each sensor (1).



Note:

If the pressure in a tyre is too low or the temperature is too high, the colour of the display changes from white to yellow or red.



Note:

As a consequence of tolerances and temperature compensation, tyres with the same inflation pressure may be displayed with different colours (white, yellow or red).

5. “Ereignisse” (Events) main menu

In the “Ereignisse” (Events) main menu, the driver is able to view the event notifications that are currently present. As each event notification constitutes a separate submenu and the quantity of event notifications is ever changing, the submenus in this main menu are not individually numbered.

Display screen menu control logic

“Übersicht” (Overview) submenu



M54.00-2315-71

The overview presents a collection of symbols, one for each event notification. The symbol colour indicates the urgency of the notifications, i.e. red alerts (1) are represented by red symbols and yellow alerts (2) by yellow symbols. Other event notifications (3) are represented by white symbols. Each notification category is designated one line containing a total of four symbol positions.

“Ereignismeldungen” (Event notifications) submenu



M54.00-2316-71

Each event notification has its own submenu in which the notification is explained in more detail. In these submenus, symbol (1) is supplemented by two lines of text (2). The display layout is the same regardless of the notification category.

Display screen menu control logic

Display screen sequence at start-up



M54.00-2361-71

After the ignition starter switch has been switched to ON, the first display to appear on the display screen is the standby screen with the marquee logo. If a fault occurs at this point, a corresponding fault alert will be displayed. If no fault occurs, the system checks whether there are any event notifications present. If there are, the associated pop-up window opens and the driver has to acknowledge the event notifications in

order of their urgency. The system then verifies whether the supply pressures for the various compressed-air circuits are at acceptable levels. If so, the bus graphic in the “Fahrzeug” (Vehicle) main menu is then displayed. However, if a supply pressure is too low, which may be the case if the vehicle has been parked up for a long period, a pop-up window displaying the supply pressures for the various compressed-air circuits opens (see illustration). The pop-up window closes automatically as soon as the necessary operating pressure is reached. If the driver acknowledges the pop-up window using the main menu buttons on the steering wheel before the correct pressure has been reached, another pop-up window opens and displays a red alert informing the driver once more that the operating pressure is still too low. If the necessary operating pressure is now reached, or if the driver acknowledges the red alert, the bus graphic in the “Fahrzeug” (Vehicle) main menu will be displayed.

**Note:**

The operating pressure can be viewed in main menu 4, submenu 1.

Menu selection

The driver can select menus manually using the buttons on the steering wheel. In addition, provided specific conditions are fulfilled, the menus alternate between the “Türen und Klappen” (Doors and flaps) submenu and the “Splitscreen Fahrerassistenzsysteme und Navigation” (Driver assistance systems and navigation splitscreen) or “Fahrerassistenzsystem” (Driver assistance system) submenu automatically so that the driver is always provided with all the necessary information while the bus is stationary or in motion without the driver having to select these menus manually.

Screen display with bus stationary

M54.00-2307-71

The driver is shown the “Türen und Klappen” (Doors and flaps) submenu if any of the doors or flaps are open. The submenu is also displayed immediately after the ignition is switched on. If the driver changes menu manually, the “Splitscreen Fahrerassistenzsysteme und Navigation” (Driver assistance systems and navigation splitscreen) submenu will no longer appear automatically while the vehicle is in motion.

Event notifications



Note:

The “Türen und Klappen” (Doors and flaps) submenu continues to be displayed during slow-speed manoeuvres if luggage compartment flaps are still open.

Screen display while the bus is in motion



M54.00-2318-71

As soon as all doors and flaps are closed and the bus travels faster than a defined minimum speed, the view changes automatically to the driving mode screen display. This screen displays operating notifications (if present) and IBIS inform-

ation. The view reverts to the “Türen und Klappen” (Doors and flaps) submenu as soon as one of the doors is opened.



Note:

If the driver had selected a different menu before this menu change (e.g. “Splitscreen Fahrerassistenzsysteme und Navigation” (Driver assistance systems and navigation splitscreen)), the view changes from the “Türen und Klappen” (Doors and flaps) submenu to the menu that the driver had selected.

Event notifications

Red alert



M54.00-2352-71

In the event of a red alert, a symbol (2) for the affected vehicle system appears in the pop-up window with explanatory text (3) below. A signal also sounds. In addition, red status indicator (4) appears on the display screen. The driver is able to acknowledge red alerts using the main menu buttons on the steering wheel but not until the vehicle has been brought to a halt and the parking brake has been applied. Acknowledging the alert simply closes the pop-up window. For as long

as the alert remains active, it continues to be displayed in the “Ereignisse” (Events) menu.



In the event of a red warning level malfunction, the bus must be stopped immediately (traffic conditions permitting) and an OMNIplus Service Partner must be notified.

Yellow alert



M54.00-2320-71

In the event of a yellow alert, a pop-up window (1) appears. The pop-up window displays a symbol (2) for the vehicle

system concerned and two lines of explanatory text (3) below it. In addition, yellow status indicator (4) lights up on the display screen. Each yellow alert has to be acknowledged by the driver manually using main menu buttons (5) on the steering wheel. Pop-up window (1) closes when the alert is acknowledged. For as long as the alert remains active, it continues to be displayed in the “Ereignisse” (Events) menu.



Caution:

In the event of a yellow warning level malfunction, it is permissible to drive on carefully but the bus should be checked by an OMNIplus Service Partner at the earliest opportunity.

Service notification



M54.00-2321-71

Service notifications generally inform the driver that service products need to be replenished or wear parts need to be replaced. In the event of a service notification, status indicator (1) on the display screen lights up. To view all service notifications, the driver has to go to main menu 5 (2). An overview of any events that are present is displayed first. Each event notification has its own submenu, which the driver can open using arrow buttons (3) on the steering wheel. A service notification displays symbol (4) for

Overview of the operating, function and malfunction display screen

the vehicle system concerned and two lines of explanatory text (5) below it. The event notification is not cleared until the fault has been rectified.

Overview of the operating, function and malfunction display screen









M68.00-0426-71

Display screen (1) is a status indicator that displays operating, function and malfunction information (icons). Additionally, it can be used to display on-board diagnostics information.











Note:







The following icons can be displayed on the display screen:

Symbol	Description
	Alternator malfunction
	Alternator 1 malfunction
	Alternator 2 malfunction
	Alternator 3 malfunction
	Automatic increase in idling speed
	Battery undervoltage
	Battery overvoltage

Overview of the operating, function and malfunction display screen























Symbol	Description
	Economy stage 3 (displayed automatically with ignition ON and engine OFF). With the engine running, most of the available electrical consumers are switched off in economy stage 3 (e.g.: refrigerator, on-board kitchenette, ceiling blowers, etc.)
	Economy stage 2 (consumers switched off in addition to those of economy stage 1. Example: auxiliary heating, etc.). This economy stage is displayed only while the engine is running.

Symbol	Description
	Economy stage 1 (individual, non-essential consumers switched off. Example: ceiling blowers, etc.). This economy stage is displayed only while the engine is running.
	FPS 1 malfunction
	FPS 2 malfunction
	FPS 3 malfunction
	FPS 4 malfunction
	FPS 5 malfunction
	FPS 6 malfunction









Symbol	Description
	FPS 7 malfunction
	FPS 8 malfunction
	Power supply FPS 1
	Power supply FPS 2
	Power supply FPS 3
	Power supply FPS 4
	Power supply FPS 5
	Power supply FPS 6









Driver's area controls









Overview of the operating, function and malfunction display screen

Symbol	Description	Symbol	Description	Symbol	Description
	Power supply FPS 7		Transmission 1st gear		Engine oil level too low
	Power supply FPS 8		Transmission 2nd gear		Engine oil pressure too low
	Engine control malfunction or failure		Transmission 3rd gear		Coolant level too low
	Engine power reduction, fault in exhaust gas cleaning system, or malfunction in Power Boost System		Transmission malfunction		Coolant temperature too high
	Drive control malfunction or failure		Retarder malfunction		Brake circuit 1 and/or 2 supply pressure sensor malfunction
	Transmission in neutral		Retarder preselected		Brake circuit 1 supply pressure too low
	Reverse gear selected		Retarder active		Brake circuit 2 supply pressure too low
			Retarder temperature too high		Parking brake applied

























Overview of the operating, function and malfunction display screen

Symbol	Description
	Pedal-activated continuous braking disabled
	Brake pad wear
	Bus stop brake active
	Bus stop brake malfunction or emergency release switch operated
	ABS/ASR system failure or malfunction
	Brake system wheel speed sensor malfunction
	ABS trailer malfunction
	Electronic Stability Program (ESP) deactivated









Symbol	Description
	Electronic Stability Program (ESP) malfunction
	Auxiliary consumers compressed-air supply pressure too low or sensor failure
	Circuit 1 supply pressure display
	Circuit 2 supply pressure display
	Circuit 3 supply pressure display
	Bus not at normal level
	Bus above normal level
	Bus below normal level









Symbol	Description
	Upper target level reached
	Lower target level reached
	Level control air pressure too low
	RAS system pressure too low
	Steering hydraulics oil level too low
	Axle load transfer active
	Trailing axle steering malfunction
	Trailing axle steering inactive









Overview of the operating, function and malfunction display screen

Symbol	Description	Symbol	Description	Symbol	Description
	Lubrication system		Brake lamps faulty		Rain/light sensor malfunction
	Trailer turn signals		Reversing lamp		Emergency valve for door 1 or door 2 operated
	Main-beam headlamps faulty		Reversing lamp faulty		Emergency hammer removed
	Dipped-beam headlamps faulty		Automatic headlamps malfunction		Emergency valve disabled
	Side lamps faulty		Window defrost set to MAX		Stop request
	Trailer turn signals faulty		Driver's window open		Ramp request
	Front foglamps faulty		Washer fluid level		Pushchair request
	Rear foglamp faulty		Rain sensor malfunction		Wheelchair bay stop request

Overview of the operating, function and malfunction display screen

Symbol	Description
	AC compressor in operation
	Antifog mode active
	Interior temperature/HVAC malfunction alert
	“Smog” air-recirculation mode for driver's area and passenger compartment
	Roof hatch emergency unlocked (emergency exit)
	Roof hatches
	Auxiliary heating unit combustion indicator
	Auxiliary heating unit not available

Symbol	Description
	Malfunction, general
	Ignition starter switch malfunction
	Belt warning
	Engine compartment fire detection system
	Engine compartment fire extinguishing system
	Emergency exit opened
	Smoke alarm
	Fuel reserve

Symbol	Description
	Fuel tank level sensor
	AdBlue® fluid level too low
	Unauthorised door lock
	SOS luggage compartment
	Engine compartment flap open
	Engine compartment flap and roof hatches open
	Steering wheel keypad malfunction
	FMS (fleet management system) message

Instrument cluster "button assignment"

Instrument cluster "button assignment"

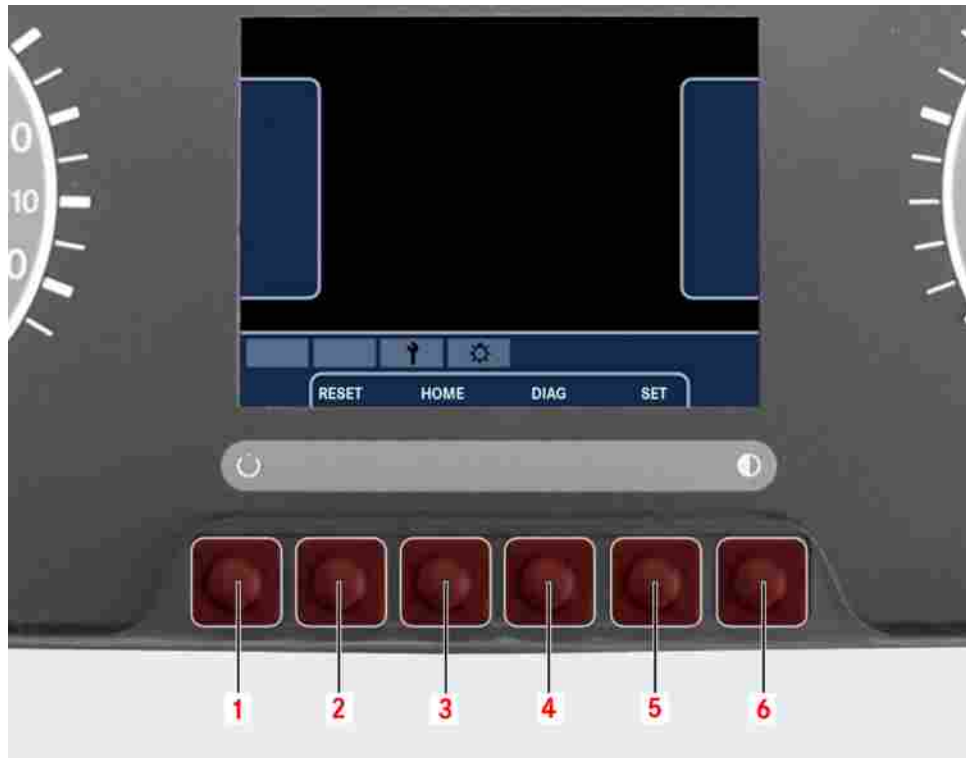



Note:

The buttons and display assignments may vary, depending on the customer's specification.

4



Caution:

No changes to settings may be made unless the bus is stationary and the parking brake is applied.

5

1 Reset button



Note:

To reset the trip meter.

2 Reset button

6



Note:

To reset trip computer data

3 Home button



Note:

Press button briefly: To reset to factory settings (language and turn signal buzzer volume).

4 Diag button



Note:

To call up on-board diagnostics.

5 Set button



Note:

To set the language and adjust the volume of the turn signal buzzer.

6 Dimming button



Note:

To adjust the display brightness (day - night brightness).

Resetting the trip meter



M54.00-2365-71

- ▶ Press and hold button (1) to reset trip meter (2) to 0.

Trip computer data manual reset

Trip computer data manual reset

i **Note:**

The trip computer calculates the distance covered, driving time, average speed and average fuel consumption since the start or last reset.

i **Note:**

The “Ab Start” (After start) trip computer data are reset automatically whenever the ignition remains switched off for longer than four hours. A manual reset is also possible.

i **Note:**

The “Ab Reset” (After reset) trip computer data continue to be incremented until they are reset manually by the driver.



M54.00-2364-71

Press RESET button (2)

i **Note:**

If the “Reiserechner” (Trip computer) main menu is already open, the trip computer data are reset if the driver presses RESET button (2) on the instrument cluster.

The “Ab Start” (After start) pop-up window opens.

i **Note:**

The pop-up window closes automatically if no button is pressed within 10 seconds.

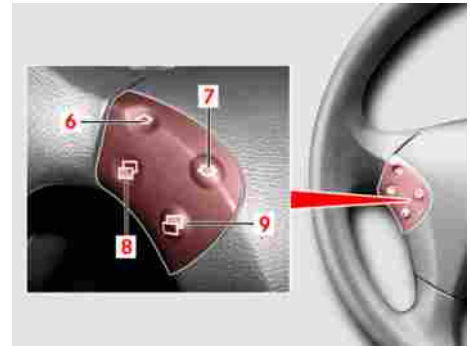

M68.00-0646-71

- ▶ The driver can close the pop-up window at any time using menu button (8) or (9).
- ▶ Using buttons (6) and (7), it is possible to toggle between “Ab Start” (After start) and “Ab Reset” (After reset).

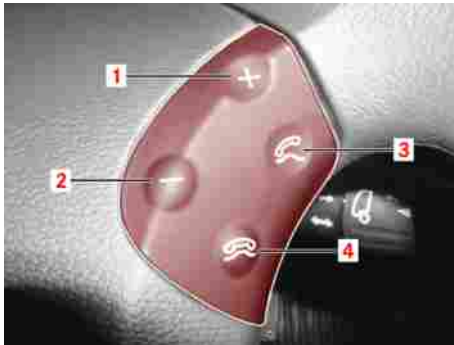

M46_00-0188-71

- ▶ To reset the trip computer data, either press button (1) on the steering wheel or press RESET button (2) on the instrument cluster.

i **Note:**

The trip computer data currently displayed are reset.

- ▶ To close the pop-up window, press menu button (8) or (9) on the steering wheel.

i **Note:**

The pop-up window closes automatically if no button is pressed within 10 seconds.



M54.00-2366-71

- ▶ Briefly pressing “HOME” button (3) reverts to the “Factory settings” (language and turn signal buzzer volume).

i **Note:**

The press of the button is not indicated on the display screen.

Menu button

Menu button

- ▶ If the steering wheel keypad fails, the menu levels last selected can be called up using the menu button.



Note:

If the ignition is OFF, it is only the first submenu of a main menu that can be called up.



This symbol appears in conjunction with a yellow alert in the event of a steering wheel keypad failure or malfunction.



Caution:

In the event of a yellow warning level malfunction, it is permissible to drive on carefully but the bus should be checked by an OMNIplus Service Partner at the earliest opportunity.

DIAG button (on-board diagnostics)



Note:

Button (4) has no function if on-board diagnostics has been omitted at the customer's request.



M54.00-2367-71

- ▶ DIAG button (4) is used to call up the on-board diagnostics system.



Note:

On-board diagnostics may be carried out only by an authorised specialist.



M54.00-2368-71

- ▶ On-board diagnostics pop-up window (1)



Note:

Using plus button (1) on the steering wheel, it is possible to call up pending fault alerts from the individual systems.

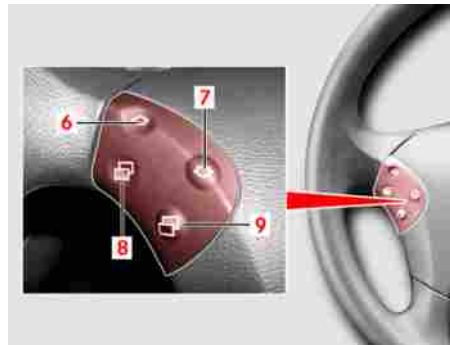

M68.00-0646-71

- ▶ Press button (7) to browse.



Note:

The "On-board diagnostics" pop-up window does not close automatically. Main menu button (8) or (9) is the only means by which it can be hidden.

SET button

- ▶ The SET button can be used to set the relevant language and adjust the volume of the turn signal buzzer.
- ▶ Preconditions: Bus stationary, parking brake applied, at least ignition ON.

Setting the language



M54.00-2323-71

- ▶ Press SET button (5) on the instrument cluster.

“SET” pop-up window (1) opens.



Note:

The driver can close the pop-up window using menu button (8) or (9), otherwise it will close automatically after 10 seconds.

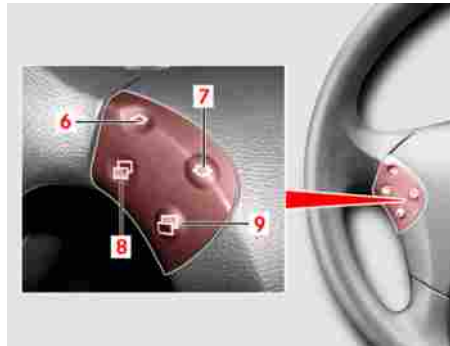

M68.00-0646-71

- ▶ Select “Sprache” (Language) using arrow button (6) or (7).

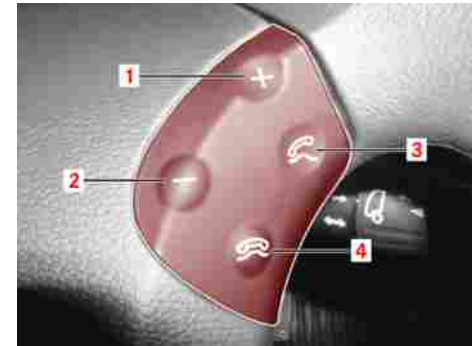

M46_00-0188-71

- ▶ Confirm with plus button (1).



M54.00-2325-71

The language currently set is displayed.

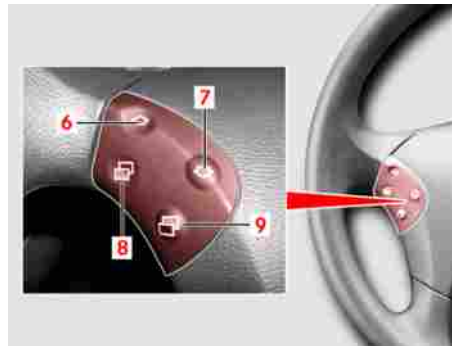

M68.00-0646-71

- ▶ Select the desired language using arrow button (6) or (7). The newly selected language (6.2) appears greyed out.

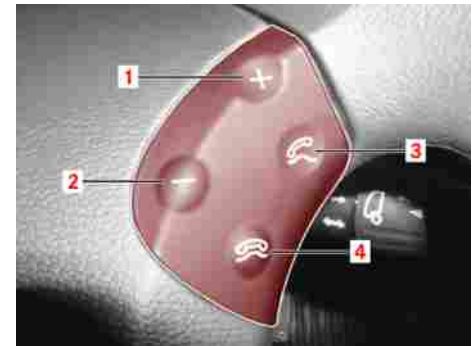

M46_00-0188-71

- ▶ Activate the newly selected language using plus button (1) or minus button (2).



Note:

The desired language is represented by text (6.2) and the flag symbol.

Adjusting the volume of the turn signal buzzer

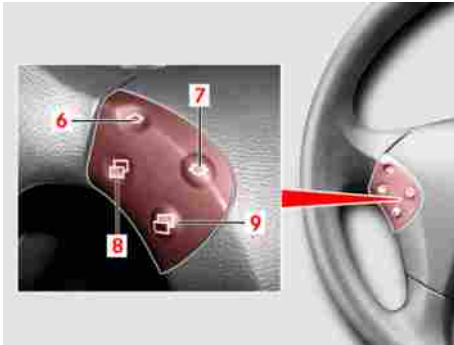

M68.00-0646-71

- ▶ To close the pop-up window: Press menu button (8) or (9).



Note:

The window closes automatically after 10 seconds.

Adjusting the volume of the turn signal buzzer



M54.00-2327-71

- ▶ Press SET button (5) on the instrument cluster.

“SET” pop-up window (1) opens.



Note:

The pop-up window closes automatically if no button is pressed within 10 seconds.

- ▶ Using arrow button (6) or (7), select “Blinkersummer” (Turn signal buzzer) and press the plus button to confirm.



M54.00-2328-71

“Blinkersummer” (Turn signal buzzer) pop-up window (1) opens.

Adjusting the display brightness (daytime brightness)

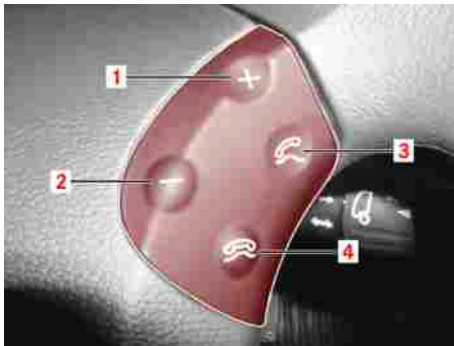

M46_00-0188-71

- ▶ The volume can now be adjusted using plus button (1) or minus button (2).

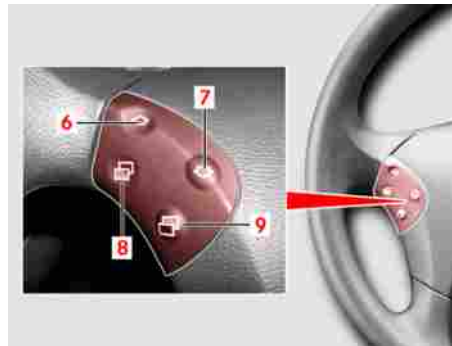

M68.00-0646-71

- ▶ To close the pop-up window, press menu button (8) or (9).

i **Note:**

The pop-up window closes automatically if no button is pressed within 10 seconds.

i **Note:**

The pop-up window closes automatically as soon as the parking brake is released.

Adjusting the display brightness (daytime brightness)

- ▶ Turn the rotary light switch to position "0".

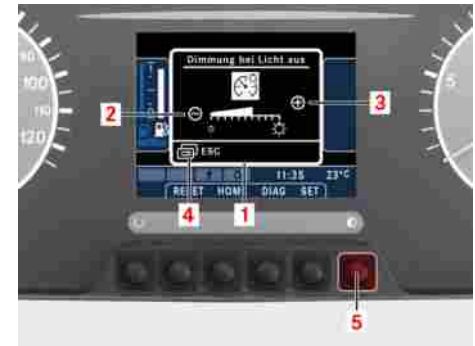

M54.00-2329-71

- ▶ Press dimmer button (5) on the instrument cluster.

The "Dimmung bei Licht aus" (Dim value with lights off) pop-up window (1) opens.

Adjusting the display brightness (night brightness)

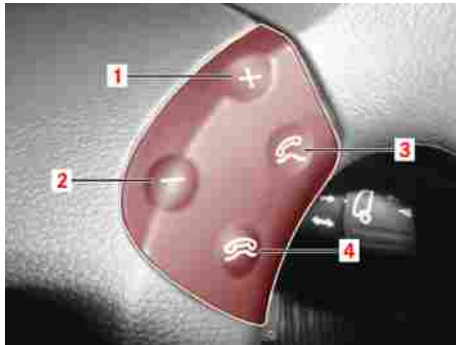

M46_00-0188-71

- ▶ The brightness can now be adjusted using plus button (1) or minus button (2).



Note:

The driver can close the pop-up window at any time using menu button (8) or (9).



Note:

The pop-up window closes automatically if no button is pressed within 10 seconds.

Adjusting the display brightness (night brightness)

- ▶ Turn the rotary light switch to headlamps.



Note:

The basic value for the display brightness is adjusted with the headlamps switched on (night brightness).

Adjusting the display brightness (night brightness)

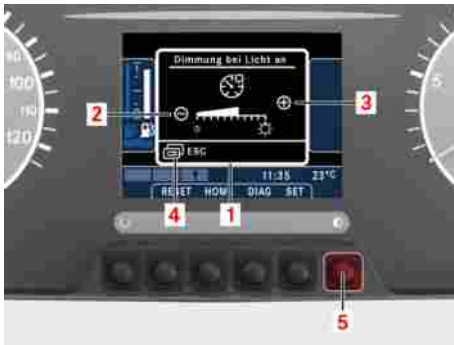

M54.00-2330-71

- ▶ Press dimmer button (5) on the instrument cluster.

A pop-up window entitled “Dimmung bei Licht an” (Dim value with lights on) (1) opens.

i Note:

The driver can close the pop-up window at any time using main menu button (8) or (9).

i Note:

The pop-up window closes automatically if no button is pressed within 10 seconds.

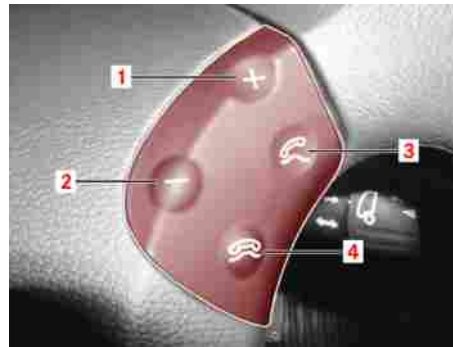

M46_00-0188-71

- ▶ The brightness can now be adjusted using plus button (1) or minus button (2).

Right-hand steering wheel buttons

Right-hand steering wheel buttons

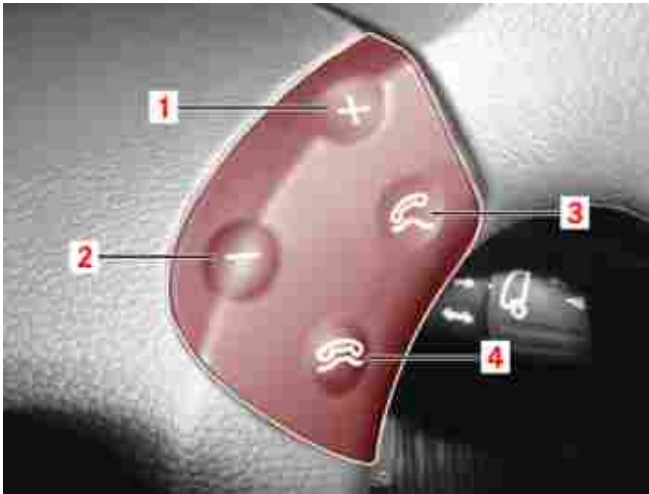

- 1 Plus key
Pop-up windows "Turn signal volume adjustment", "Display screen brightness adjustment".
- 2 Minus key
Pop-up windows "Turn signal volume adjustment", "Display screen brightness adjustment".
- 3 To pick up the telephone
(function not assigned)
- 4 To hang up the telephone
(function not assigned)

Left-hand steering wheel buttons

Left-hand steering wheel buttons

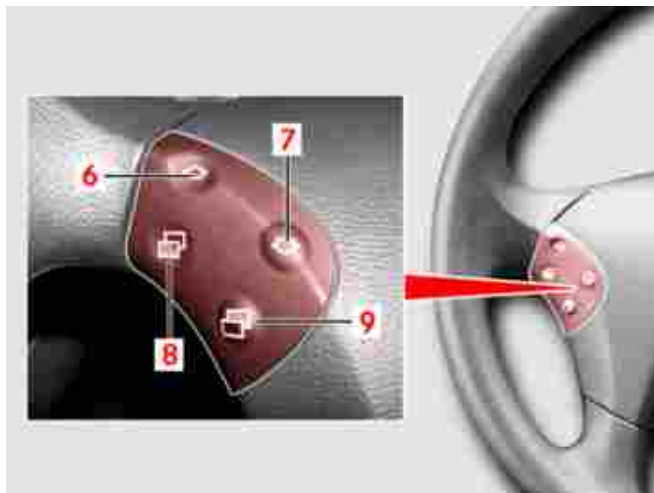

Vehicle manoeuvrability with the air suspension depressurised

- 6 Next arrow button
*To go to the next submenu up
To move up a line in a list*
- 7 Back arrow button
*To go to the next submenu
down
To move down a line in a list*
- 8 Next main menu button
*To go to the next main menu
up
To close a pop-up window*
- 9 Back main menu button
*To go to the next main menu
down
To close a pop-up window*

Vehicle manoeuvrability with the air suspension depressurised

The forward section of the chassis and the guidance of the driven axle have been structurally designed in such a way as to ensure that the bus remains manoeuvrable when the suspension air bags have been depressurised.

In this condition, the full weight of the vehicle body is supported by the stop buffers fitted at the forward section of the chassis and at the rear axle. These stop buffers are unladen when the suspension is at normal level and are intended only to prevent the body of the vehicle from dropping onto the axle in the event of extreme suspension compression. The stop buffers are not designed for permanent loading and cannot be used as a replacement for the normal suspension under any circumstances. The bodywork could otherwise suffer damage (cracks, etc.).



Danger.

Although the bus remains manoeuvrable while the suspension is depressurised, it must be driven no faster than walking pace to the nearest lay-by or OMNIplus Service Partner. Whenever work is carried out on the air suspension system, the body must always be supported by jacks and stands positioned at the designated points because the body of the bus could drop relatively quickly in the event of a loss of air.

Lowering/raising the bus on the boarding side

Lowering/raising the bus on the boarding side



Note:

Precondition: Electrical system on, bus stationary, doors closed, operating pressure > 6.5 bar, red indicator lamp off, lowering/raising with key switch on, level control operational.



Danger.

Risk of accident. Use the lowering function only with the bus stationary and for no purpose other than as a boarding aid.



Danger.

Risk of accident. Ensure that no objects or persons are present under the bus, particularly their feet.



M54.00-1752-71

- ▶ Press and hold the lower section of pushbutton (1) until the bus has finished lowering.

The bus lowers on the boarding side.

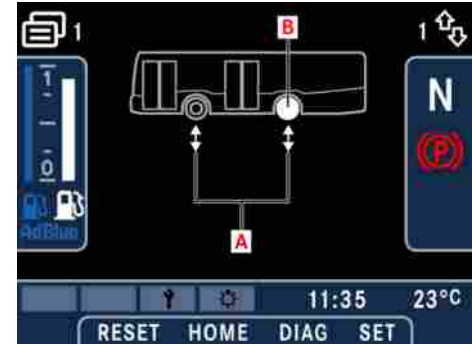

M54.00-2331-71

While the bus is being lowered, the display screen shows: “Bus lowering” (A), “Drive-off lock active” (B).

Lowering/raising the bus on the boarding side

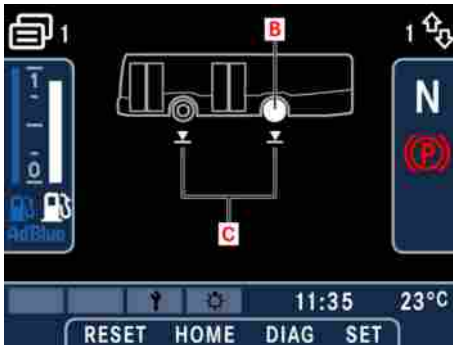

M54.00-2332-71

After the lowering process, the display screen shows: “Lowering complete” (C), “Drive-off lock active” (B).

i Note:

After the bus has been lowered, it is possible to open the doors and extend the ramp.

- ▶ Briefly press the upper section of pushbutton (1).

The bus is raised back to the normal level.

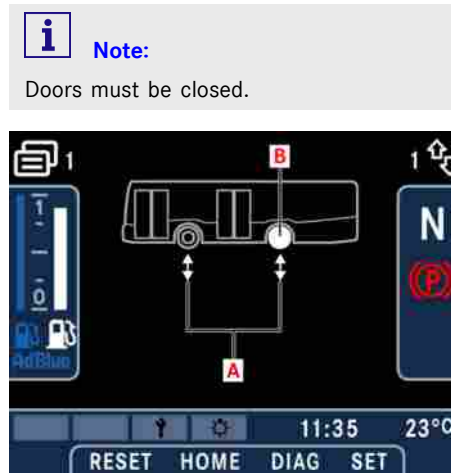

M54.00-2331-71

While the bus is being raised, the display screen shows: “Bus rising” (A), “Drive-off lock active” (B).

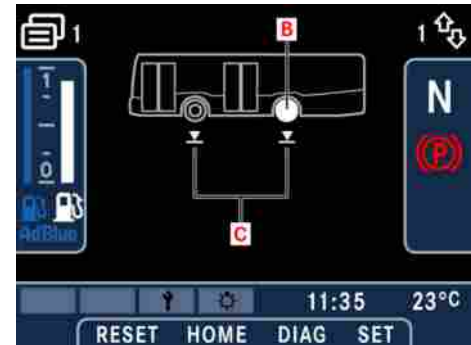

M54.00-2332-71

After the raising process, the display screen shows: “Raising complete” (C), “Drive-off lock active” (B).

i Note:

The bus is raised automatically if the doors are closed or pushbutton (1) is released during the lowering process.

Raising the bus above normal level

Raising the bus above normal level



Note:

Precondition: Electrical system on, bus stationary, doors closed, operating pressure > 6.5 bar, red indicator lamp off, lowering/raising with key switch on, level control operational.



Danger.

Risk of accident. Do not exceed the maximum permissible vehicle height when driving with the bus raised above normal level. In Germany, the maximum permissible vehicle height is limited to 4 metres. Observe local statutory regulations in all other countries (especially in the event of cross-border travel).



M54.00-1755-71

- ▶ Press the upper section of pushbutton (2) in bus stop mode.

The bus is raised for as long as the pushbutton is pressed.



Note:

Release the pushbutton as soon as the bus has reached the desired height.

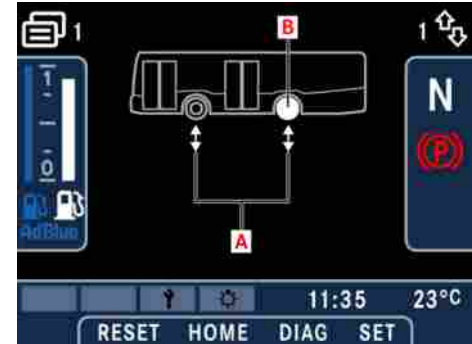

M54.00-2331-71

The following appears on the display screen: "Raised level active" (A).



Note:

This function is displayed if the "Bus stop mode" display is active.

- ▶ Press the upper section of pushbutton (2) in driving mode.

The bus is raised for as long as the pushbutton is pressed.

Raising the bus above normal level



M54.00-1756-71

The buzzer sounds briefly. Yellow indicator lamp (3) lights up briefly.

The following appears on the display screen: “Bus raised” (B).

i Note:

This function is displayed if the “Driving mode” display is active.

i Note:

Release the pushbutton as soon as the bus has reached the desired height.



M54.00-1755-71

- ▶ Briefly press the lower section of pushbutton (2).

The bus is lowered to the normal level.

The function indicator on the display screen goes out.

i Note:

Lowering is cancelled if pushbutton (2) is pressed up during the lowering process.

Activating/deactivating the pull-away aid

Activating/deactivating the pull-away aid

- ▶ Electrical system on
- ▶ Bus travelling less than 12 mph (20 km/h)



Note:

The pull-away aid has the effect of relieving the load on the trailing axle. The load on the driven axle is increased. This reduces the tendency of the drive wheels to spin on a slippery road surface.



M54.00-1757-71

- ▶ Press the lower section of pushbutton (1).

The pull-away aid is activated.

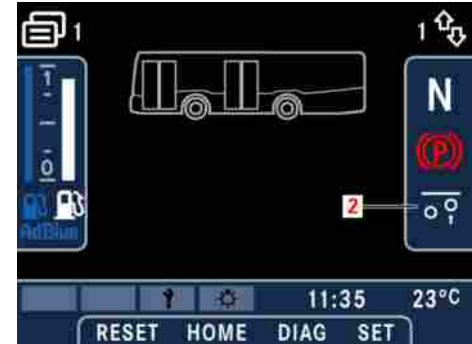

M54.00-2333-71

The following appears on the display screen: "Pull-away aid active" (2).

- ▶ Press the lower section of pushbutton (1) again.

The pull-away aid is deactivated.



M54.00-2333-71

“Pull-away aid active” indication display (2) on the display screen goes out.

i Note:

The pull-away aid is deactivated automatically as soon as the bus travels faster than 20 mph (30 km/h). “Pull-away aid active” indication display (2) on the display screen goes out.

Applying the parking brake

i Note:

Precondition: Minimum operating pressure of 5.5 bar.

! Danger.

Risk of accident. If the “Brake system malfunction” indicator lamp lights up while there is sufficient operating pressure available, there must be a defect in the parking brake circuit. Have the brake system checked at an OMNIplus Service Partner.

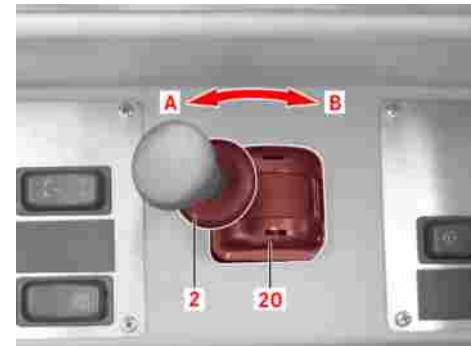

M42_00-0657-71

- ▶ Pull the parking brake lever back (A) and engage it.

The parking brake is applied (air venting noise can be heard).

! Danger.

Do not apply the parking brake unless the bus is stationary. Always apply the parking brake before you leave the driver's area. On steep uphill and downhill gradients, you should also chock the wheels and turn the steering towards the kerb.

Releasing the parking brake

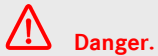

Danger.

Check the hand lever for full engagement. To do so, attempt to press the hand lever in the “release” direction (B) without pulling release ring (2) out of the detent position. The lever must not move.



M54.00-2334-71

The following appears on the display screen: “Parking brake applied” (A).

Releasing the parking brake

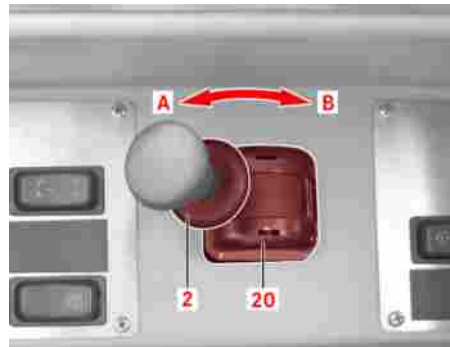

M42_00-0657-71

- ▶ Pull locking ring (2) up and push parking brake lever (20) forwards (B).

The parking brake is released (air charging noise can be heard).



M54.00-2334-71

The “Parking brake applied” indication display (A) on the display screen goes out.



Note:

A continuous warning tone sounds if the electrical system is switched off with the parking brake released.

Emergency braking in the event of failure of both brake circuits

**Note:**

To guarantee a faultless release of the parking brake, the supply pressure must be at least 5.5 bar. If the parking brake indicator lamp does not go out even if there is sufficient supply pressure available, there is a defect in the brake spring cylinder circuit or the emergency release circuit. Have the brake system checked by an OMNIplus Service Partner immediately.

Emergency braking in the event of failure of both brake circuits

**Danger.**

A failure in brake circuits 1 and 2 will jeopardise the operating safety and road-worthiness of the bus. Stop the vehicle immediately (traffic conditions permitting). Have the brake system checked by an OMNIplus Service Partner immediately.

**Note:**

In the event of a failure in brake circuits 1 and 2, it is possible to initiate emergency braking using the parking brake lever.

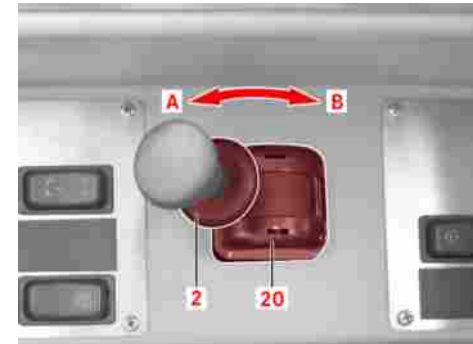

M42_00-0657-71

- ▶ Pull release ring (2). Slowly pull the hand lever towards the Applied position (A) and hold it in the desired position, otherwise it will automatically return to the Released position (B).

**Danger.**

If you ever need to use the parking brake for emergency braking, do not allow it to engage in the parking position. Release ring (2) must be held in the applied position.

Activating/deactivating the bus stop brake

The bus is braked at the rear wheels only.



Note:

It is possible to pull the parking brake lever back to any position before the limit position. This enables you to prevent the rear wheels from locking and to control the amount of braking force applied.



Danger.

Risk of accident. Applying the parking brake deactivates the anti-lock braking system (ABS). You should exercise even more caution when driving on slippery roads because there would be a risk of rear wheels locking.

Activating/deactivating the bus stop brake



Note:

Precondition: Bus stationary, electrical system on.



Danger.

If the bus stop brake is not used as intended, the vehicle could roll away. This could result in an accident with serious or fatal injuries. For this reason, always apply the parking brake before you start/stop the engine or leave the driver's area. Do not under any circumstances use the bus stop brake as a parking brake or hillholder. Apply the parking brake whenever you come to a stop on a steep uphill or downhill gradient of more than 15 % or pull into a bus stop on a steep uphill or downhill gradient of more than 15 %. Do not activate the bus stop brake unless the vehicle is stationary.



M54.00-1762-71

- ▶ Press the lower section of switch (1).

The bus stop brake is active.



Danger.

If the parking brake is subsequently applied, the bus stop brake will be released. After the parking brake is released again, the bus stop brake will be reactivated after a delay. For this reason, it is essential that the service brake be applied during this time.

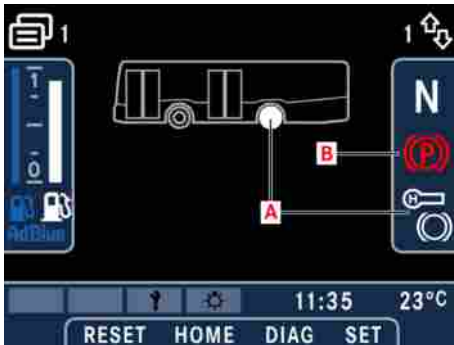

M54.00-2335-71

The following appears on the display screen: "Bus stop brake active" (A).

- Press the upper section of switch (1); depress the accelerator pedal.

The bus stop brake is released.

Note:

The drive-off lock is not released until the accelerator pedal is depressed.

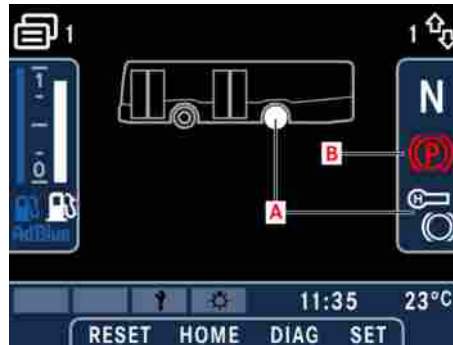

M54.00-2335-71

The "Bus stop brake active" indication display (A) on the display screen goes out.

Drive-off lock

Note:

Precondition: Bus stationary, electrical system on.

Danger.

If the drive-off lock is not used as intended, the vehicle could roll away. This could result in an accident with serious or fatal injuries. Therefore: - Always apply the parking brake before you start/stop the engine or leave the driver's area. - Do not under any circumstances use the drive-off lock as a parking brake or hill-holder. - Apply the parking brake whenever you come to a stop on a steep uphill or downhill gradient of more than 15 % or pull into a bus stop on a steep uphill or downhill gradient of more than 15 %.

- Open the door.

The following appears on the display screen: "Drive-off lock active" (A). Additionally, the status indicator for the action is also displayed.

Important information on the steering system

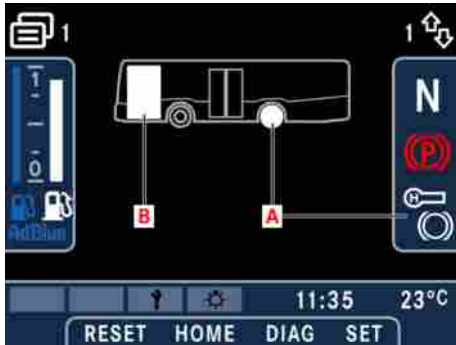

M54.00-2336-71

In the example: “Door open” (B).



Note:

The drive-off lock is also activated if the following systems are active: “Lower bus”, “Operate ramp”, “Operate lift”.

- ▶ Close the door, depress the accelerator pedal.

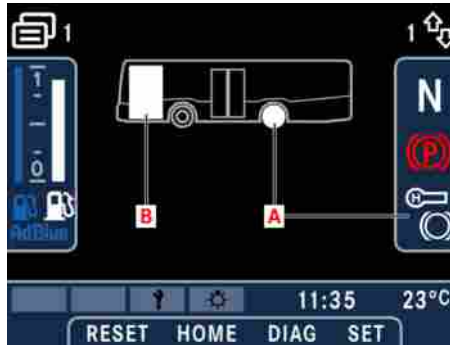

M54.00-2336-71

The “Drive-off lock active” indication display (A) on the display screen goes out.



Note:

The drive-off lock is not released until the accelerator pedal is depressed.

Important information on the steering system

The dimensions of the steering system and the mechanical steering transmission ratio were designed such that, in the event of a malfunction in the hydraulic power steering system, the effort required to turn the steering wheel would not exceed a specific value deemed by legislators to be the maximum reasonable force.

For vehicles weighing over 12 t, this maximum operating force is 450 N (400 N for vehicles between 3.5 t and 12 t) applied to the steering wheel rim in the straight-ahead position. This force must be sufficient to achieve a turning circle with a radius of 20 m at a road speed of approximately 10 km/h. No more than 6 seconds may elapse between the start of turning and the moment the 20 m radius is achieved.

The driver must be aware that, in the event of a sudden failure in the power steering (e.g. due to a pump drive malfunction), the bus will remain steerable

but considerably more effort will be required.

Since there is an extremely low probability of this situation occurring - but if it does occur, it often does so completely unexpectedly - the driver could wrongly assume that the steering system has been blocked. However, the bus does remain steerable provided the driver applies the necessary force.

This important information is intended to clarify the scenario described and prevent the driver from possibly misjudging the situation.



Danger.

In the event of a power steering failure, the bus becomes very difficult to steer. Have the malfunction rectified immediately by an OMNIplus Service Partner.

Adjusting the steering wheel



Note:

Precondition: Bus stationary, electrical system on, driver's seat adjusted and parking brake applied (bus stop brake applied, one door open, bus lowered)



Danger.

Adjust the steering wheel before the start of a journey and never when the vehicle is in motion. There is an increased risk of accident if you release the steering wheel during stops in traffic. The steering wheel would instantly engage in its current position the moment the vehicle pulled away again.



M46.15-0009-71

- ▶ Press the lower section of switch (1).
The steering column lock is released.

Turning the steering wheel when the bus is stationary



M46.15-0008-71

- ▶ Raise, push or tilt the steering wheel.

Both the height and angle of the steering wheel can be adjusted to a position most suitable for the driver's height and arm length.



Note:

The instrument panel adjusts along with the steering wheel.

- ▶ Press the upper section of switch (1).
The steering wheel and instrument panel are locked in their current position.

Turning the steering wheel when the bus is stationary

- ▶ Observe the instructions and information.



Note:

To prevent damage to the steering column, the following points must be observed when turning the steering wheel with the bus stationary, without hydraulic support (engine switched off) and without a turntable under the front wheels (tyres in direct contact with the ground):

- ▶ Release the steering wheel adjuster and push the steering wheel fully down. Lock the steering wheel adjuster in place. Turn the steering wheel using both hands placed apart at an angle of between 90° and 180°.

Opening/closing the driver's window



Caution:

Never have more than one person turn the steering wheel. Do not pull the steering wheel on one side only.



Note:

We ask the workshop in particular to note this.

Opening/closing the driver's window



Note:

Precondition: Electrical system on.



Danger.

Risk of injury. Monitor closing of the driver's window to ensure that nobody can become trapped.



M54.00-1764-71

- ▶ Press the lower section of pushbutton (1).
The window opens.
- ▶ Press the upper section of pushbutton (1).
The window closes.

Switching the mirror and window heating on and off



Note:

The window stops moving if you release power windows pushbutton (1) when opening or closing the driver's window.

Switching the mirror and window heating on and off



Note:

Precondition: Engine running.



Note:

The window and the exterior mirror heating is limited to approximately 12 minutes.



M54.00-1765-71

- ▶ Press the lower section of pushbutton (1).

The indicator lamp in pushbutton (1) lights up.

The heating is active.



The following appears on the display screen: "Window/exterior mirror heated".

Switching the mirror and window heating on and off

- ▶ Press the upper section of pushbutton (1).

The indicator lamp in switch (1) goes out.

The heating is switched off.



The “Window/exterior mirror heated” indication display on the display screen goes out.

Important notes on the driver's seat	180
Grammer MSG 90.5 driver's seat control elements	182
Using the driver's seat belt	184

Important notes on the driver's seat

Important notes on the driver's seat

It is essential that the following instructions be observed:



Danger.

In the interests of road safety, the driver's seat must not be adjusted when the bus is in motion.



Note:

The following descriptions provide a brief overview of the control elements. The manufacturer's operating instructions provided must be observed in all cases.







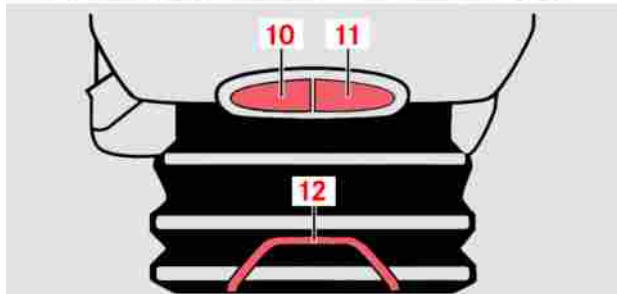
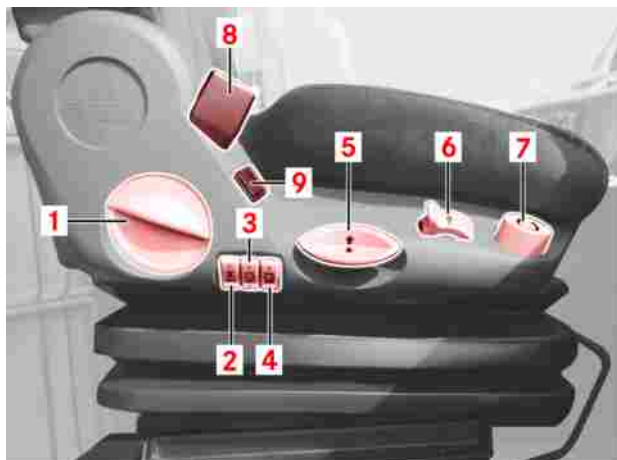



Driver's seat/passenger seats

Grammer MSG 90.5 driver's seat control elements

Grammer MSG 90.5 driver's seat control elements



Grammer MSG 90.5 driver's seat control elements

- | | | | |
|---|---|----|---|
| 1 | Backrest adjustment | 9 | Seat heating switch (option) |
| | <p> Note:</p> <p>Relieve load on backrest, pull lever upwards, move into required position, release lever.</p> | 10 | Seat cushion angle adjustment |
| 2 | Lateral support adjustment | | <p> Note:</p> <p>Relieve load on backrest, pull button upwards: the seat angle can now be adjusted.</p> |
| | <p> Note:</p> <p>Individually adjustable lateral support by two compressed-air chambers. (+) chamber fills up or (-) chamber empties.</p> | 11 | Seat cushion depth adjustment |
| 3 | Lumbar support (upper chamber) | | <p> Note:</p> <p>Pull button upwards: the seat cushion can now be adjusted.</p> |
| | <p> Note:</p> <p>(+) chamber fills up or (-) chamber empties.</p> | 12 | Driver's seat fore-and-aft adjustment |
| 4 | Lumbar support (lower chamber) | | <p> Note:</p> <p>Pull lever upwards: the seat can now be slid in the longitudinal direction.</p> |
| | <p> Note:</p> <p>(+) chamber fills up or (-) chamber empties.</p> | 5 | Height adjustment |
| | <p> Note:</p> <p>Pull lever up = upward adjustment. Push lever down = downward adjustment.</p> | 6 | Damper setting |
| | <p> Note:</p> <p>The damper setting can be infinitely adjusted between soft and hard.</p> | 7 | Swivel release mechanism |
| | <p> Note:</p> <p>Press button downwards: the seat can now be turned (swivel range: 50° to the left, 90° to the right).</p> | 8 | Seat belt buckle |

Using the driver's seat belt

Using the driver's seat belt



Note:

The driver's seat fitted has an integrated belt system. The user instructions therefore only apply to belts that were installed in the manufacturing plant.



Note:

Section 21a of the German road traffic regulations (StVO) stipulates that the seat belt must be buckled while the vehicle is in motion. Observe the legal requirements in all countries concerned.

- ▶ Fastening the seat belt: pass the seat belt untwisted and tightly across your pelvis and shoulder and insert the tongue into the belt buckle until you hear it engage.



Danger.

The seat belt must not pass over your neck, be snagged or rub against sharp edges. It should fit as close to the body as possible. You should therefore avoid wearing bulky clothing. Do not route the seat belt over solid or fragile objects in pockets in your clothing. Frequently retighten the seat belt over your shoulder.

- ▶ Releasing the seat belt: press the red button in the belt buckle and assist the inertia reel by guiding the seat belt back.

Automatic transmission - general	186
Tilting the seat row on the transmission cover	187
Selector positions of the 3-pushbutton switch panel	188
Selector positions of the 6-pushbutton switch panel	190

Automatic transmission - general

Automatic transmission - general



Danger.

Risk of accident. The bus is free to move with the transmission in neutral “N” and the brakes released. Apply the parking brake and press pushbutton N whenever the bus is parked or work is to be carried out on the bus with the engine running. Do not shift down on a slippery road surface (risk of skidding). Press pushbutton N when there is a risk of sliding and skidding. For a brief stop, such as at a bus stop or traffic lights, keep the gearshift unit in its current position and bring the bus to a halt using the service brake or bus stop brake. Shift down in good time on long uphill or downhill gradients, especially when under a big load.



Note:

Changing gear with the automatic transmission: the engine can only be started when the transmission is switched to the neutral position N. The individual gears are changed automatically in response to the position of the switches, the road speed and the accelerator pedal position.



Note:

Driving away: apply the service brake. Select the gearshift position by pressing a pushbutton with the engine at idling speed (accelerator pedal not depressed). Do not release the brake until the bus begins to pull away. There is otherwise a risk of the bus pulling away too soon (bus creeps). On upwards slopes release the brake and simultaneously depress the accelerator pedal.



Note:

Accelerator pedal positions: little throttle for low acceleration and sooner upshifts. More throttle for high acceleration and later upshifts. Kickdown (depressing the accelerator pedal to the stop beyond the full throttle position) for maximum acceleration. The transmission shifts down to a lower gear if the road speed is below the maximum speed for the next gear down. The transmission shifts up when the engine is running at rated speed.

Tilting the seat row on the transmission cover

Tilting the seat row on the transmission cover

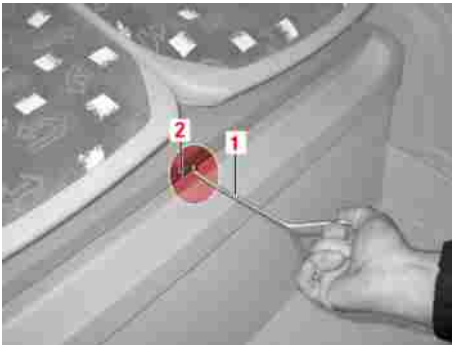

M00.01-0012-71

- ▶ Insert hook spanner (1) into opening (2).

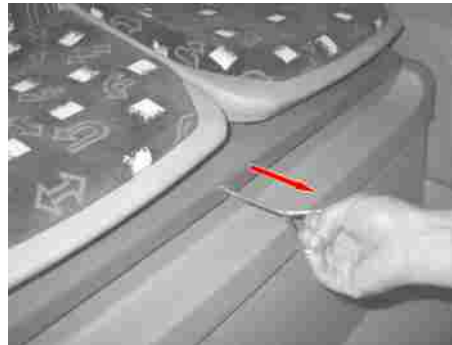

M00.01-0014-71

- ▶ Engage the hook spanner in the locking mechanism.
- ▶ Pull the hook spanner in the direction of the arrow.



M00.01-0013-71

- ▶ Fold the seat row forwards.



Caution:

Risk of entrapment for fingers and hands.

Selector positions of the 3-pushbutton switch panel

Selector positions of the 3-pushbutton switch panel



Note:

Precondition: pushbutton “N” pressed, bus stationary, service brake applied, accelerator pedal released (engine speed < 900 rpm).



Note:

Applies to the automatic transmissions: ZF Ecomat 6-speed transmission and Voith 4-speed automatic transmission.



Note:

Each button lights up when pressed.



Caution:

If the pressed button begins to flash, this is a warning that there is a severe risk of transmission damage (limited system monitoring). In this event, it is permitted to drive on to the nearest workshop but only with the engine under partial load.



Caution:

Observe the towing guidelines if the transmission is damaged.

▷ For towing guidelines, refer to the “Operation” section of the Operating Instructions.



M54.00-1769-71

▶ Press switch “R”.

The automatic transmission shifts to reverse gear.



Danger.

Risk of accident. Do not shift into reverse gear unless the bus is stationary and the engine is running at idling speed.

Selector positions of the 3-pushbutton switch panel



Note:

It is necessary to press the “N” button first if button “D” is pressed after button “R” or if button “R” is pressed after button “D”.



Note:

During reverse travel, a warning tone will sound if this feature has been requested by the customer or stipulated by national regulations.



M54.00-1767-71

- ▶ Press switch “N”.

The automatic transmission shifts to neutral.

The bus is free to move if no brakes are applied. There is no power transmission from the engine to the driven axle.



M54.00-1768-71

- ▶ Press switch “D”.

Gears 1 to 4 (4-speed transmission) or 1 to 6 (6-speed transmission) are automatically selected in succession.



Note:

Drive position “D” provides ideal driving characteristics in almost all operating situations.

Selector positions of the 6-pushbutton switch panel

Selector positions of the 6-pushbutton switch panel



Note:

Precondition: pushbutton “N” pressed, bus stationary, service brake applied, accelerator pedal released (engine speed < 900 rpm).



Note:

Applies to the automatic transmissions: ZF Ecomat 6-speed transmission and Voith 4-speed automatic transmission.



Note:

Each button lights up when pressed.



Caution:

If the pressed button begins to flash, this is a warning that there is a severe risk of transmission damage (limited system monitoring). In this event, it is permitted to drive on to the nearest workshop but only with the engine under partial load.



Caution:

Observe the towing guidelines if the transmission is damaged.

▷ For towing guidelines, refer to the “Operation” section of the Operating Instructions.



M54.00-1770-71

▶ Press switch “R”.

The automatic transmission shifts to reverse gear.



Danger.

Risk of accident. Do not shift into reverse gear unless the bus is stationary and the engine is running at idling speed.

Selector positions of the 6-pushbutton switch panel



Note:

It is necessary to press the “N” button first if button “1” or “D” is pressed after button “R” or if button “R” is pressed after button “1” or “D”.



Note:

During reverse travel, a warning tone will sound if this feature has been requested by the customer or stipulated by national regulations.



M54.00-1771-71

- ▶ Press switch “N”.

The automatic transmission shifts to neutral.

The bus is free to move if no brakes are applied. There is no power transmission from the engine to the driven axle.



M54.00-1772-71

- ▶ Press switch “D”.

Gears 1 to 4 (4-speed transmission) or 1 to 6 (6-speed transmission) are automatically selected in succession.



Note:

Drive position “D” provides ideal driving characteristics in almost all operating situations.

Selector positions of the 6-pushbutton switch panel



M54.00-1773-71

- ▶ Press switch 3.

The transmission shifts through gears 1 to 3 automatically.



Note:

For driving on slight to moderate uphill gradients to prevent transmission hunting between 3rd and 4th gear.

On a downhill gradient, this selector position makes full use of the engine braking effect up to the maximum permissible engine speed in 3rd gear.



M54.00-1774-71

- ▶ Press switch 2.

The transmission shifts between gears 1 and 2 automatically.



Note:

For driving on moderate uphill gradients to prevent transmission hunting between the 2nd and 3rd gear.

On a downhill gradient, this selector position makes full use of the engine braking effect up to the maximum permissible engine speed in 2nd gear.



M54.00-1775-71

- ▶ Press switch 1.

For driving on steep uphill gradients and for manoeuvring the bus at slow speeds.



Note:

Only 1st gear is selected.

On a downhill gradient, this selector position makes full use of the engine braking effect up to the maximum permissible engine speed in 1st gear.

Safety instructions for the air-conditioning system	195
Operating instructions for the air-conditioning system	195
Heating/ventilation/air-conditioning control panel - driver's area	196
Heating/ventilation/air-conditioning control panel - complete bus	198
Driver's area - setting the air distribution/demisting the windscreen	199
Driver's area - adjusting the temperature	200
Driver's area - adjusting the blower speed	201
Driver's area - cooling	202
Additional driver's area ventilation (option)	203
Switching air-recirculation mode on and off	203
Passenger compartment – switching automatic temperature regulation on and off - code HH2/HK1	204
Passenger compartment – switching automatic temperature regulation on and off	205
Switching the auxiliary heating on and off	206
Switching the reheat function on and off	208
Passenger-compartment temperature - changing the base value	209
Opening/closing the roof hatches	212

Table of contents

Fans on/off	215
Switching the fans on/off (bus with air-conditioning system)	216
Auxiliary heating preset timer (option)	218
Operating the auxiliary heater (option)	219
Programming the auxiliary heating preset times	222

Safety instructions for the air-conditioning system

Air-conditioning systems that are operated with refrigerant R 134 a are labelled with appropriate stickers and/or plates on the compressor.

Never mix R 134 a refrigerant and the corresponding DEA Triton SE 55 refrigerator oil with other products.

It is forbidden to disregard the latest technological standards and allow refrigerant to escape into the environment when servicing or decommissioning air-conditioning systems.

Refrigerant and refrigerator oils must be disposed of separately, or recycled.

Maintenance work on air-conditioning systems as well as removal of refrigerants and oils may only be carried out by persons who have the relevant and necessary specialist knowledge, technical equipment and official approval (control of health and safety at work, local government, TÜV).

The operator must maintain a logbook auditing the consumption of refrigerant and refrigerator oils.



Danger.

On automatically controlled air-conditioning systems, the ventilation blowers can be started at any time by the condenser or evaporator units. Therefore turn the ignition switch to the OFF position when carrying out cleaning work. Do not reach into the fan blades or fan rollers. Avoid any contact with refrigerant as there is a risk of frostbite. Treat affected skin areas as for frostbite, and contact a doctor straight away. Carry out maintenance and repair tasks with the engine switched off whenever possible. Keep a safe distance from moving parts (e.g. belt drive) when the engine is running.

Operating instructions for the air-conditioning system



Note:

The driver's window should remain closed while the vehicle is in motion and the air-conditioning is operating to ensure faultless operation of the air-conditioning system.

Heating/ventilation/air-conditioning control panel - driver's area

Heating/ventilation/air-conditioning
control panel - driver's area

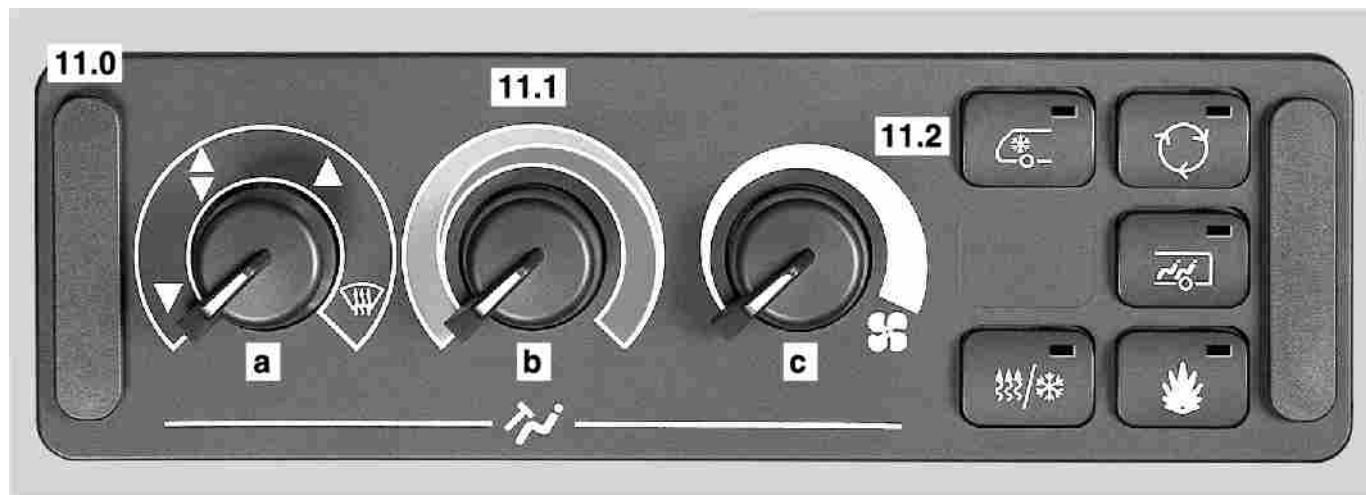

- a Air distribution
 - b Temperature control
 - c Blower output
- 11.2 Driver's area cooling

Heating/ventilation/air-conditioning control panel - complete bus

Heating/ventilation/air-conditioning
control panel - complete bus

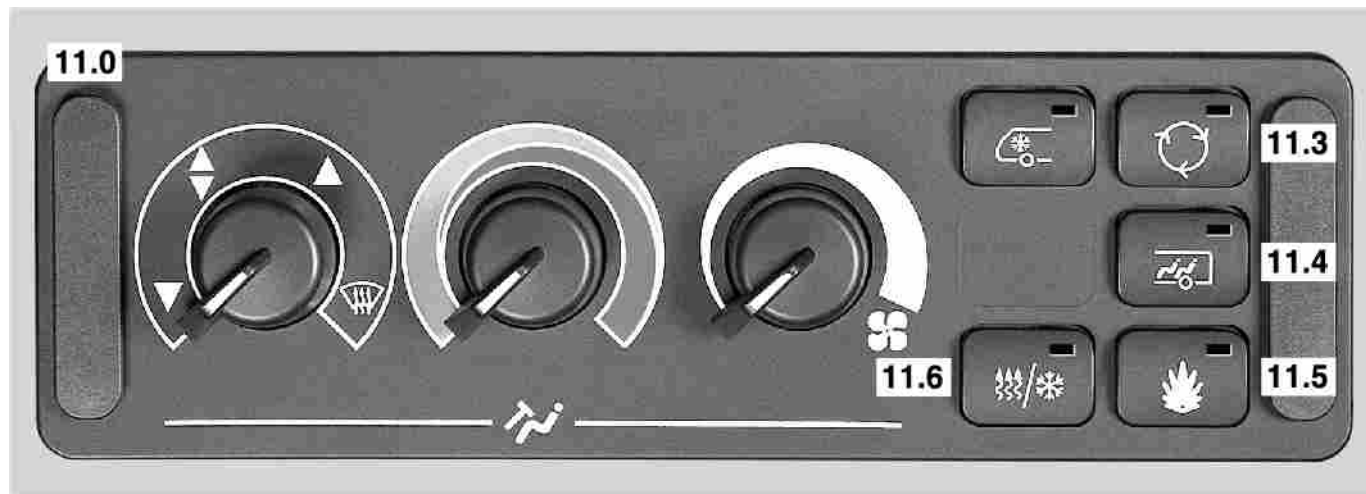

Driver's area - setting the air distribution/demisting the windscreen

- 11.3
 - 1. Air-recirculation mode
 - 2. To increase the base value for the passenger-compartment temperature
- 11.4
 - 1. Passenger-compartment temperature control on/off
 - 2. To call up the program for changing the base value
 - 3. To confirm the base value for the passenger-compartment temperature
- 11.5
 - 1. "Auxiliary heating on/off"
 - 2. To decrease the base value for the passenger-compartment temperature
- 11.6 : "Reheat on/off"

Driver's area - setting the air distribution/demisting the windscreen



Note:

Precondition: electrical system on.



M83_00-0132-01

- ▶ Turn switch (a) to position 1.

Air flows out: - in the footwell to the right-hand side of the steering column (adjustable), in the footwell on the left-hand side (non-adjustable), at the left-hand side windows, at the right-hand side of the

- driver's cab, at the driver's platform and at the instrument panel.
- ▶ Turn switch (a) to position 2.
- Air flows out: - in the footwell, at the left-hand side windows, at the right-hand side of the driver's cab, at the driver's platform, at the instrument panel and at the windscreen.

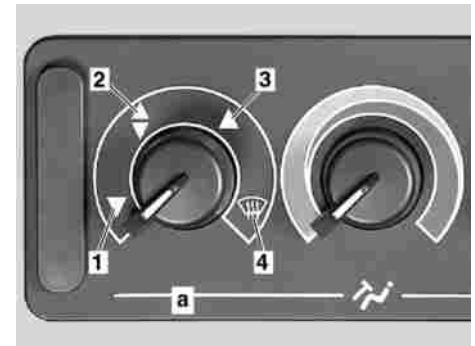

M83_00-0132-01

- ▶ Turn switch (a) to position 3.

Air flows out: at the windscreen and at the instrument panel

Driver's area - adjusting the temperature

- ▶ Turn switch (a) to position 4 (windscreen demisting).

Air flows out: at the windscreen (for demisting) and at the instrument panel



Note:

The blower runs at maximum output and cannot be regulated.



Note:

Air is permanently blown out the following air vents: instrument panel, front right footwell (adjustable), right-hand side of driver's cab.

Driver's area - adjusting the temperature



Note:

The target temperature for the driver's area is infinitely adjustable.

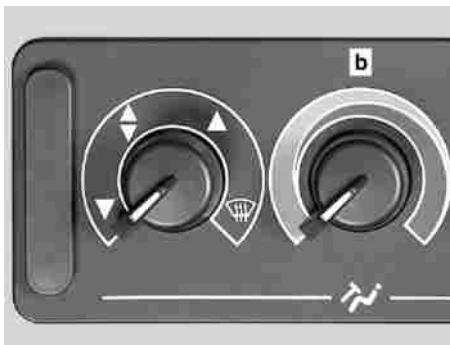

M83_00-0056-01

- ▶ Turn switch (b) clockwise into the red area.

The temperature in the driver's area is increased.

- ▶ Turn switch (b) anti-clockwise into the blue area.

The temperature in the driver's area is reduced.

Driver's area - adjusting the blower speed

i **Note:**

Precondition: electrical system on, engine running.

i **Note:**

The blower speed in the driver's area is continuously variable.



M83_00-0055-01

- ▶ Turn switch (c) clockwise.

The blower speed is increased.

i **Note:**

Maximum blower speed is not available unless the engine is running.

i **Note:**

In economy mode with the electrical system switched on but with the engine switched off, the blower will operate only at minimum speed.

- ▶ Turn switch (c) anti-clockwise.
The blower speed is reduced.

Driver's area - cooling

Driver's area - cooling



Note:

Precondition: engine running, switch “b” in the blue area, outside temperature above 12 °C.



Note:

In buses with a roof-mounted air-conditioning system (refer to vehicle variant description), driver's area cooling can be activated only in conjunction with passenger compartment cooling.



M83_00-0120-01

- ▶ Press pushbutton (11.2).



Note:

The air-conditioning system must be operated at least once a month (even in the cold season) in order to maintain the leak-tightness of the slide ring seal on the compressor crankshaft.



Note:

The maintenance program for the compressor cannot be operated unless the outside temperature is above 0 °C and the coolant temperature (engine circuit) is above 50 °C.

Driver's area cooling control is activated.

The indicator lamp in pushbutton (11.2) lights up.

- ▶ Press pushbutton (11.2) again.

Driver's area cooling control is deactivated.

The indicator lamp in pushbutton (11.2) goes out.

Additional driver's area ventilation (option)



Note:

Precondition: electrical system on.



M83_00-0753-71

- ▶ Turn rotary knob (1) clockwise to increase blower output.
The air distribution can now be set using air vents (2).

Switching air-recirculation mode on and off



Note:

Precondition: electrical system on.



M83_00-0121-01

- ▶ Press pushbutton (11.3).
The indicator lamp in pushbutton (11.3) lights up.
The roof hatches are closed.
The fresh-air flaps are closed.
The roof ventilators switch off.



Note:

Air-recirculation mode remains active for approximately 10 minutes. Normal mode is resumed automatically after this time.

- ▶ Press pushbutton (11.3) again.
The indicator lamp in pushbutton (11.3) goes out.
The roof hatches are opened.
The fresh-air flaps are opened.
The roof ventilators switch on.

Passenger compartment – switching automatic temperature regulation on and off - code HH2/HK1

Passenger compartment – switching automatic temperature regulation on and off - code HH2/HK1

i Note:

Precondition: electrical system on, engine running.

i Note:

With the engine switched off, economy mode is active and the roof ventilators remain switched off.

i Note:

If the electrical system has been switched on but the engine is not running, the blowers operate only at the lowest output level.

i Note:

Passenger compartment cooling is activated only if the interior temperature rises above 22 °C.



M83_00-0122-01

- ▶ Press pushbutton (11.4).

Automatic passenger-compartment temperature regulation is switched on.

The indicator lamp in pushbutton (11.4) lights up.

i Note:

The temperature in the passenger compartment is regulated automatically in line with the outside temperature and the desired temperature set for the passenger compartment.

i Note:

Blower output is infinitely increased or reduced and the roof ventilators are switched on or off in line with the temperature in the passenger compartment.

- ▶ Press pushbutton (11.4) again.
Automatic passenger-compartment temperature regulation is switched off.
The indicator lamp in pushbutton (11.4) goes out.

Passenger compartment – switching automatic temperature regulation on and off



Note:

All current settings are retained whenever passenger-compartment regulation is switched off. Automatic regulation is re-activated when passenger-compartment regulation is switched on again.

Passenger compartment – switching automatic temperature regulation on and off



Note:

Precondition: electrical system on, engine running.



Note:

With the engine switched off, economy mode is active and the roof ventilators remain switched off. If the electrical system has been switched on but the engine is not running, the blowers operate only at speed 1. Fresh air is fed into the passenger compartment through the hinged windows and by the roof ventilators.



M83_00-0122-01

- ▶ Press pushbutton (11.4).

Automatic passenger-compartment temperature regulation is switched on.

The indicator lamp in pushbutton (11.4) lights up.



Note:

The temperature in the passenger compartment is regulated automatically in line with the outside temperature and the desired temperature set for the passenger compartment.

Switching the auxiliary heating on and off



Note:

Blower output is infinitely increased or reduced and the roof ventilators are switched on or off in line with the temperature in the passenger compartment.

- ▶ Press pushbutton (11.4) again.
Automatic passenger-compartment temperature regulation is switched off.
The indicator lamp in pushbutton (11.4) goes out.

Switching the auxiliary heating on and off



Note:

Precondition: electrical system on.



Danger.

Risk of poisoning and asphyxiation. The auxiliary heating must not be used in enclosed spaces such as garages or workshops due to the risk of poisoning and asphyxiation. Timer and preselection mode are similarly prohibited.



Danger.

Risk of explosion. The auxiliary heating must be switched off at filling stations and fuel dispensing systems due to the risk of explosion.



Danger.

Risk of fire. The auxiliary heating must remain switched off in places where ignitable vapours or dust can accumulate (e.g. in the vicinity of filling stations, fuel depots, or coal, sawdust or grain stores or similar).



Danger.

Risk of fire and burns. There is a risk of fires and burns due to the high exhaust temperatures and the hot exhaust pipe for the auxiliary heating. For this reason, do not stop or park the bus over ignitable materials (e.g. grass) when the auxiliary heating is in operation, has recently been in operation or has been operated by the instant heating button/preset timer.



Note:

Operation of the auxiliary heating is limited to approximately 30 minutes with the electrical system switched off.



Note:

The auxiliary heating has to be switched on manually. It is not activated automatically.



M83_00-0123-01

- ▶ Press pushbutton (11.5).

The auxiliary heating switches on after approximately 10 to 15 seconds.

The indicator lamp in pushbutton (11.5) lights up.



The following appears on the screen: “Auxiliary heating on”.



Note:

Each press of the pushbutton initiates an auxiliary heating start-up attempt. The auxiliary heating will be disabled electronically after 10 unsuccessful start-up attempts.



Note:

To re-enable the auxiliary heating: switch the on-board power supply off and on.

- ▶ Press pushbutton (11.5) again.

The auxiliary heating system switches off.

The indicator lamp in pushbutton (11.5) goes out.



The “Auxiliary heating on” indication display on the screen goes out.

Switching the reheat function on and off



Note:

If the bus is not equipped with an auxiliary heating system, pressing pushbutton (11.5) only switches the recirculation pump for the heating on and off.

The run-on time begins and lasts approximately 90 to 120 seconds.

Switching the reheat function on and off



Note:

Precondition: electrical system on, engine running.



Note:

The recirculated air (i.e. the reduced amount of fresh air) is cooled as it comes into contact with the refrigerant evaporator and reheated by the heat exchanger for the heating system. This process condenses water out of the air passed through the system. The air directed to passengers or the driver is thereby dehumidified.



M83_00-0124-01

- ▶ Press pushbutton (11.6).

Dehumidified air is delivered from the air vents.

The indicator lamp in pushbutton (11.6) lights up.



Note:

The reheat function remains active for a maximum of approximately 30 minutes.

Passenger-compartment temperature - changing the base value

- ▶ Press pushbutton (11.6) again.
The reheat function is switched off.
The air delivered from the air vents is no longer dehumidified.
- The indicator lamp in pushbutton (11.6) goes out.

Passenger-compartment temperature - changing the base value



Note:

Precondition: Electrical system on.



Note:

In case you want to change the target temperature in the passenger compartment, the control panel enables you to change the temperature base value setting within defined limits. 24 °C is the default base value programmed for the temperature in the passenger compartment and assigned to temperature regulation pushbutton (11.4). This base value can be increased to a maximum of 28 °C or reduced to a minimum of 20 °C in increments of 2 °C.



M83_00-0125-01

- ▶ Press and hold pushbutton (11.4) for at least 10 seconds.

The indicator lamps in pushbuttons (11.3), (11.4) and (11.5) may flash individually or in combination, depending on the base value currently set.

Passenger-compartment temperature - changing the base value



M83_00-0121-01

- ▶ Press pushbutton (11.3).

The base value is increased. Press once = increase by 2 °C. Press twice = increase by 4 °C.



Note:

The base value can be increased by a maximum of 4 °C.



M83_00-0123-01

- ▶ Press pushbutton (11.5).

The base value is decreased. Press once = decrease by 2 °C. Press twice = decrease by 4 °C.



Note:

The base value can be decreased by a maximum of 4 °C.



M83_00-0122-01

- ▶ Press pushbutton (11.4) again.

Adjustment of the base value is confirmed.

The indicator lamps stop flashing.

The control unit switches back to normal operation.

Passenger-compartment temperature - changing the base value



M83_00-0123-01

The following base value settings are possible: base value setting 20 °C. The indicator lamp in pushbutton (11.5) flashes.



M83_00-0126-01

Base value setting 22 °C. The indicator lamps in pushbuttons (11.4) and (11.5) flash.



M83_00-0122-01

Base value setting 24 °C. The indicator lamp in pushbutton (11.4) flashes.



Note:

By default, temperature regulation pushbutton (11.4) is programmed for a value of 24 °C.

Opening/closing the roof hatches



M83_00-0127-01

Base value setting 26 °C. The indicator lamps in pushbuttons (11.3) and (11.4) flash.



M83_00-0121-01

Base value setting 28 °C. The indicator lamp in pushbutton (11.3) flashes.

Opening/closing the roof hatches



Note:

Precondition: Electrical system on, temperature control off, windscreen wipers off.



M54.00-1795-71

- ▶ Press the upper section of pushbutton (2).

The roof hatches are raised at the rear ('air out' position).

Opening/closing the roof hatches



Note:

The red indicator lamp in the pushbutton lights up.



M54.00-2337-71

- ▶ The roof hatches are indicated on the display screen as being in 'air out' position (1).



M54.00-1795-71

- ▶ Press the upper section of pushbutton (2) again.
The roof hatches are raised at the front and rear.



M54.00-2338-71

- ▶ The roof hatches are indicated on the display screen as being in open position (1).

Opening/closing the roof hatches



M54.00-1795-71

- ▶ Press the upper section of pushbutton (2) again.

The roof hatches are raised at the front ('air in' position).

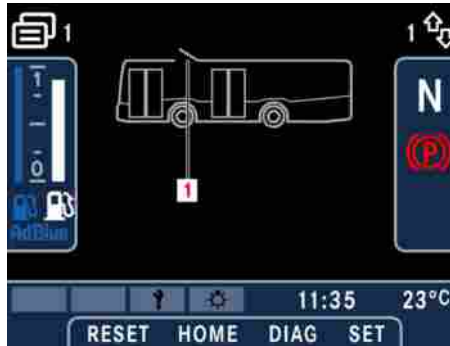

M54.00-2339-71

- ▶ The roof hatches are indicated on the display screen as being in 'air in' position (1).



M54.00-1795-71

- ▶ Press the upper section of pushbutton (2) again.

The roof hatches close. The red indicator lamp in the pushbutton goes out.



Note:

It is possible to close the roof hatches at any time by pressing the lower section of pushbutton (2).



Note:

The roof hatches close automatically when the temperature control or wind-screen wipers are switched on.



Note:

The roof hatches close automatically when the ignition is switched off.

- It is possible to prevent the roof hatches from closing automatically when the ignition is switched off. To do so, press and hold button (2) while the engine is switching off.

The roof hatches remain open ('air out' position) and the red indicator lamp in pushbutton (2) lights up.

Fans on/off



Note:

Precondition: Engine running.



Note:

Automatic fan switch-on/switch-off is enabled whenever the engine is started.



M54.00-1799-71

- Press the upper section of pushbutton (1).

The fans start to run.

The indicator lamp in pushbutton (1) lights up.



Note:

The fans switch on automatically if the interior temperature is too high (above approximately 22 °C) or whenever air-recirculation mode is deactivated.

Switching the fans on/off (bus with air-conditioning system)

- ▶ Press the lower section of pushbutton (1).

The fans switch off.

The indicator lamp in pushbutton (1) goes out.

i **Note:**

The fans switch off automatically if the interior temperature is too low or whenever air-recirculation mode is activated.

Automatic fan switch-on/switch-off is enabled again.

Switching the fans on/off (bus with air-conditioning system)

i **Note:**

Precondition: Engine on.

i **Note:**

Automatic fan switch-on/switch-off is enabled whenever the engine is started.



M54.00-1799-71

- ▶ Press the upper section of pushbutton (1).

The fans start to run.

The indicator lamp in pushbutton (1) lights up.

i **Note:**

The fans start up automatically if the output of the interior blowers rises to approximately 70 %. – air-recirculation mode is not active.

Switching the fans on/off (bus with air-conditioning system)

- ▶ Press the lower section of pushbutton (1).

The fans switch off.

The indicator lamp in pushbutton (1) goes out.



Note:

The fans stop automatically if the output of the interior blowers falls below approximately 62 %, if air-recirculation mode is active or if automatic passenger-compartment regulation is not active.

Auxiliary heating preset timer (option)

Auxiliary heating preset timer
(option)



Operating the auxiliary heater (option)

- | | | | |
|----|--|----|--|
| 1 | Activation button: To activate/deactivate the timer, to toggle display field | 11 | Display field: Time, operating period of preset time |
| 2 | Back control button: To select a function in the menu bar, to set values | 12 | Menu bar |
| 3 | Forwards control button: To select a function in the menu bar, to set values | | |
| 4 | OK button: To select a flashing symbol, or to confirm inputs | | |
| 5 | Weekday programming bar: Displays the active program memory and the respective weekday | | |
| 6 | Heating symbol: Heating switched on/off | | |
| 7 | Time symbol: AM morning, PM afternoon | | |
| 8 | Program symbol: To program the preset time | | |
| 9 | Clock symbol: To set the time/operating period | | |
| 10 | Heating symbol: Heating active status indication | | |

Operating the auxiliary heater (option)



Note:

The timer has a simple control interface. With just 4 buttons, it is possible to set and change any of the available functions as required and also to program the desired preset times.



Danger.

Risk of explosion and asphyxiation. Heater operation is not permitted: at filling stations or fuel dispensing systems, in places where ignitable vapours or dust can accumulate (e.g. in the vicinity of filling stations, fuel depots, or coal, sawdust or grain stores), in enclosed spaces (e.g. bus depot).

Operating the auxiliary heater (option)



Caution:

The heater must be operated at least once a month, with the engine cold, for at least 10 minutes.



Note:

Within 10 seconds of the last settings change or user input, the display goes blank, i.e. the timer enters standby mode. For any new input, it will then be necessary to press button (1) again.



M83.00-0947-71

- ▶ Setting the weekday, time and operating period

Press and hold button (1) for longer than 2 seconds.

Select clock symbol (5) using button (2) or (3), the symbol begins to flash.

Confirm the selection using button (4).

Weekday (6) flashes.

Select a weekday using button (2) or (3).

Confirm the selection using button (4).

Select the hours (7) using button (2) or (3).

Confirm the selection using button (4).

Set the minutes (8) using button (2) or (3).

Confirm the setting using button (4).

Set the operating period for instant ON mode using pushbutton (2) or (3).



Note:

For instant ON mode, an operating period of between 10 and 120 minutes can be selected.

Confirm the setting using button (4).



Note:

The time set is displayed.



M83.00-0948-71

- ▶ To switch on instant heating:
Press and hold button (1) for longer than 2 seconds.
Select heating symbol (5) using button (2) or (3).
Confirm the selection using button (4).



Note:

Heating mode is switched on. The display screen remains lit for the duration of the heating period.

- ▶ Switching off the heating
Select heating symbol (5) using button (2) or (3).
Confirm the selection using button (4).



Note:

Heating mode is switched off. The display illumination switches off.



M83.00-0957-71

- ▶ Switching on continuous mode
Press pushbutton (1).
L symbol (5) is displayed.
Confirm by pressing pushbutton (4).
Symbol (7) for continuous mode is displayed.

Programming the auxiliary heating preset times



Note:

Optionally, it is possible to set the heat-
ing period using button (2) or (3)

Programming the auxiliary heating preset times

► Programming preset times



Note:

The preset timer can be used to program
a heating start time in a 7-day window for
a maximum of 3 different periods ranging
in length from min. 10 minutes to max.
120 minutes. The 3 preset times can
either be on the same weekday or dis-
tributed across various weekdays. When
the heater is operating, the display screen
is illuminated. If the on-board power sup-
ply is interrupted, the timer will revert to
factory settings.



Note:

While the auxiliary heating is operation-
al, priority is given to heating the driver's
station and the windscreen with the igni-
tion switched off.



Note:

Selected symbols flash.



M83.00-0949-71

Press and hold pushbutton (1) for
longer than 2 seconds.

Select symbol P (3.1) using pushbut-
ton (2) or (3).

Confirm by pressing pushbutton (4).



M83.00-0950-71

Select memory preset 1, 2 or 3 (3.2) using pushbutton (2) or (3).



Note:

The number 1 (3.2) indicates that the first preset location of max. 3 programming presets is now occupied.

Confirm by pressing pushbutton (4).



M83.00-0951-71

Select a weekday (3.3), Mon – Sun using pushbutton (2) or (3).

Confirm by pressing pushbutton (4).



M83.00-0952-71

Set the hours (3.4) using pushbutton (2) or (3).

Confirm by pressing pushbutton (4).

Programming the auxiliary heating preset times



M83.00-0953-71

Set the minutes (3.5) using pushbutton (2) or (3).

Confirm by pressing pushbutton (4).



M83.00-0954-71

“on” (5) is displayed.

Confirm symbol (3.6) using pushbutton (4).



M83.00-0956-71

The operating period L (3.7) in minutes is displayed. This can be accepted using pushbutton (4) or changed using pushbutton (2) or (3).



Note:

The occupied memory presets 1, 2, or 3 are shown on the display screen. The next memory preset due to be activated chronologically is underlined and the respective weekday is displayed.



M83.00-0958-71

P symbol (5) flashes and the time is displayed.



Note:

To program the preset times in memory presets 2 and 3, the same procedure is required.



M83.00-0954-71

► Clearing stored preset times

To clear preset times, the same programming steps should be followed up to menu item (5) “on”.



M83.00-0955-71

Using pushbutton (2) or (3), switch to status “off” (3.8).

Confirm by pressing pushbutton (4). The respective preset is cleared and the number 1 (3.2) is no longer displayed.

Protection against entrapment in the door opening direction	228
Protection against entrapment in the door closing direction	228
Emergency operation - doors	230
Forced door closure in an emergency	232
Opening/closing door 1 from the outside	234
Locking/unlocking door leaves from the outside (option)	235
Locking door 1 with the key (option)	236
Locking/unlocking the door leaves from the inside	236
Opening/closing the doors from the inside	237
Opening/closing automatic doors from the inside	238
Opening/closing automatic doors from the outside	240
Opening/closing automatic doors	242
Switching between automatic and manual door operation	245
Teaching in the doors in the closing and opening directions	247
Pushchair stop request	250

Protection against entrapment in the door opening direction

Protection against entrapment in the door opening direction



M54.00-1800-71

If a door makes contact with an object when opening, the door leaf concerned is switched to reduced-power pushback.

The indicator lamp in the pushbutton pressed (1/2/3/4) flashes.

The door then continues to move in the opening direction.

Protection against entrapment in the door closing direction



M54.00-1800-71

If a door makes contact with an object when closing, the closing motion is reversed to open the door again.

The indicator lamp in the pushbutton pressed (1/2/3/4) lights up.

With automatic doors, the closing movement is reinitiated after the hold-open time has elapsed.

Emergency operation - doors

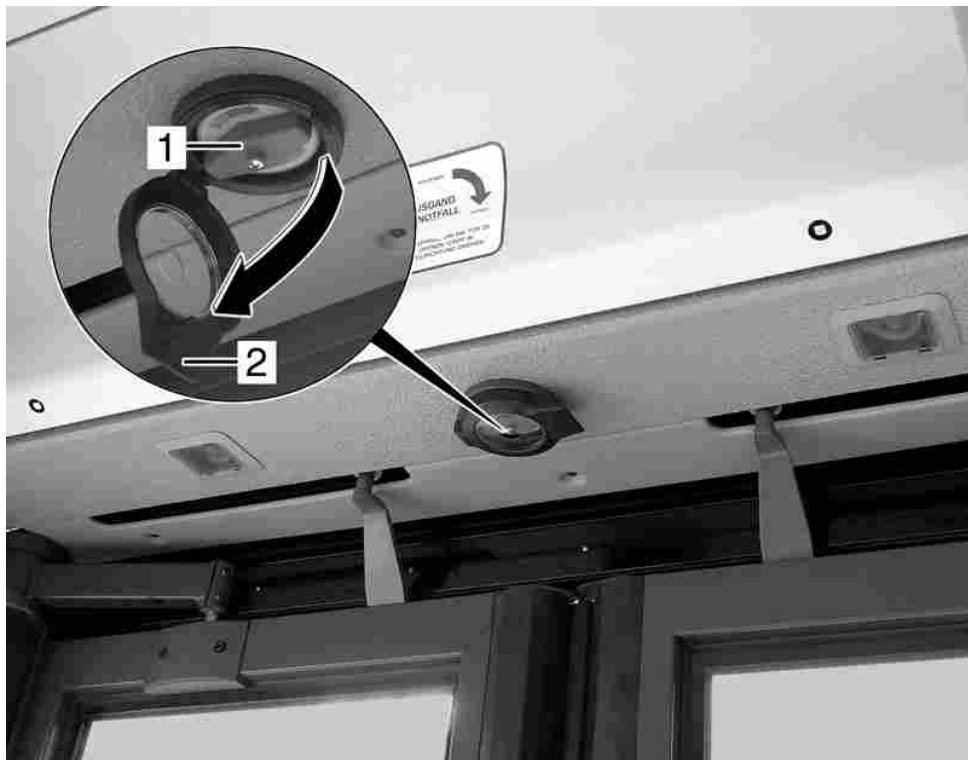

Emergency valve location

**Danger.**

Risk of accident. Do not operate the emergency valve except in emergencies.

**Note:**

There is one interior and one exterior emergency valve at each of the doors.

**Note:**

The laws and regulations of the country in which the bus is operated must be observed.

- 1 Emergency valve: After operation, the emergency valve returns to its initial position automatically.
- 2 Emergency valve cover: Open cover (2) before operating emergency valve (1).

Opening the doors in an emergency: Turn the emergency valve in the direction of the arrow from the drive position to the emergency position. The door leaves can be opened manually.

**Note:**

Warning functions when the electrical system is switched on: The red warning lamp lights up. The “Emergency valve operated” malfunction display is shown on the screen. A signal sounds. The corresponding door pushbutton on the instrument panel flashes.

**Note:**

Exterior emergency valve (1) next to the doors makes it possible for rescuers to gain access to the vehicle interior or from the outside in the event of an emergency or an accident.

**Danger.**

All doors must be unlocked before departure (refer to the “Locking/unlocking the door leaves from the inside” or “Locking/unlocking door leaves from the outside” subsections in the “Opening/locking” section of the Operating Instructions). Otherwise, it may not be possible for the doors to be opened from the outside in an emergency.

Forced door closure in an emergency



Note:

To prevent unauthorised access to the vehicle interior, the doors must be re-locked whenever the vehicle is parked.

Close the doors



Note:

Restoring operation of the door system: - Press the emergency valve reset push-button (on switch panel to left of driver) - Close the door using the door pushbutton.



Note:

The warning functions are deactivated if the corresponding door pushbutton on the instrument panel is pressed and sufficient supply pressure is available.

Forced door closure in an emergency



Note:

Precondition: Bus stationary, parking brake applied, on-board power supply on, electrical system on.



Note:

It may be possible to force a malfunctioning door to close, depending on the cause of malfunction.



Caution:

In the event of a malfunction, have the door system checked immediately at an OMNIplus Service Partner.

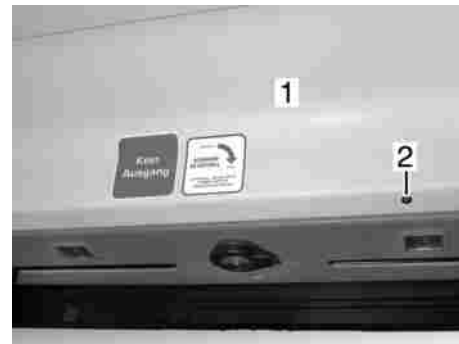

M72_00-0066-01

- ▶ Release (2) and open service cover (1) above the relevant door.

Forced door closure in an emergency

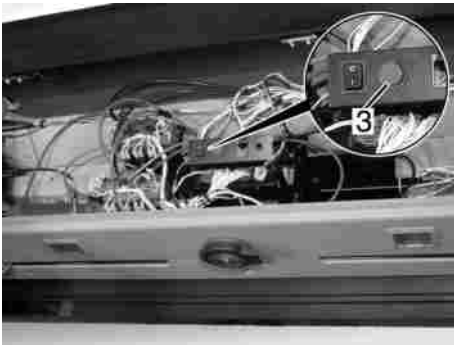

M72_00-0068-01

- ▶ Press and hold workshop pushbutton (3) until the door is closed.



Danger.

Anti-entrapment protection is inoperative if the workshop pushbutton is pressed in an emergency operation.

The door is now forced to close.

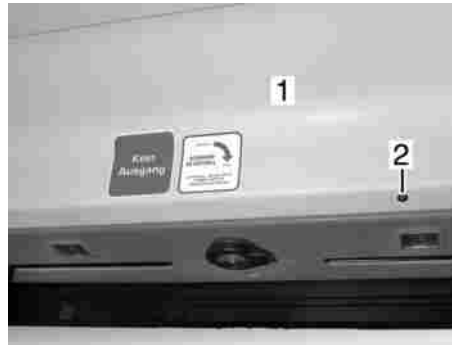

M72_00-0066-01

- ▶ Close and lock (2) service cover (1).

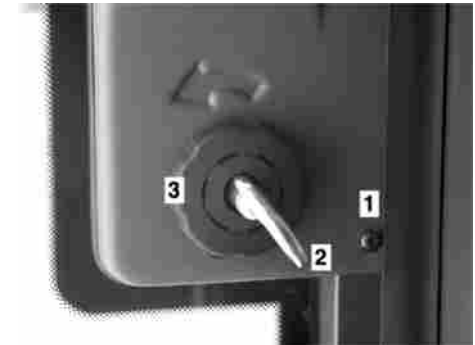

M72_00_0026-01

- ▶ Lock both door leaves from the inside with square key (2).



Caution:

In the event of a malfunction, have the door system checked immediately at an OMNIplus Service Partner.

Opening/closing door 1 from the outside

Opening/closing door 1 from the outside



Note:

Precondition: Battery voltage 24 ± 3 volts.



Note:

The installation locations of the door pushbuttons may vary.



Note:

Press and hold the door pushbutton(s) until the door leaf/door leaves move. The doors will not open if they have been locked mechanically.

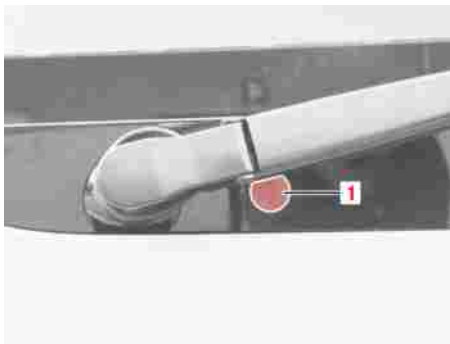

M72_00-0262-71

- ▶ Press pushbutton (1) in the centre (actuation point).



Note:

The door will not open/close if pushbutton (1) is not pressed in the centre.

- ▶ Open front flap (1).



Note:

Option

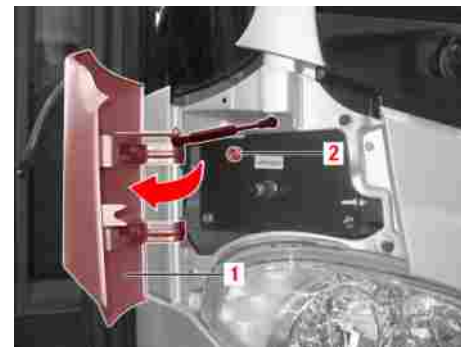

M54.00-1923-71

- ▶ Press pushbutton (2).

Locking/unlocking door leaves from the outside (option)

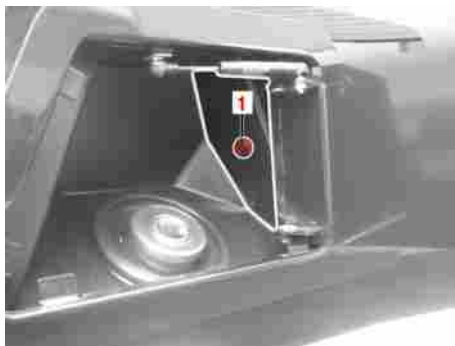

M54.00-2284-71

- ▶ Open the fuel filler flap.

**Note:**

Option

Press pushbutton (1).

Locking/unlocking door leaves from the outside (option)

**Note:**

All door leaves must be unlocked before the bus is driven.



M72_00-0024-01

- ▶ Turn lock (3) upwards (4) with square key (1).

Lock indicator (2) is black. The door leaf is locked.



M72_00-0025-01

- ▶ Turn lock (3) downwards (5) with square key (1).

Lock indicator (2) is green. The door leaf is unlocked.

Locking door 1 with the key (option)

Locking door 1 with the key (option)

- ▶ Whenever you disembark, lock door 1 from the outside using the key.



Note:

If the locked door was unlocked from the inside using the handwheel, the door cannot be locked from the outside again until the unlocking mechanism has been released.

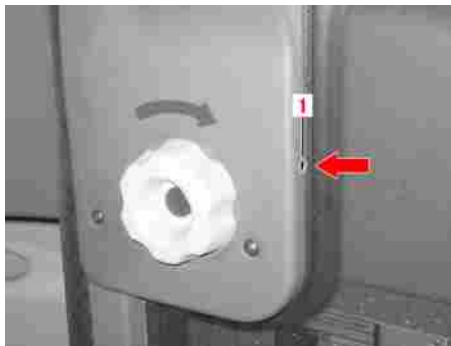

M72_00-0399-71

- ▶ To do this, using a long, pointed object (e.g. a screwdriver), operate the unlocking mechanism through opening (1) and simultaneously turn the handwheel in the opposite direction to the printed arrow.

The door can now be locked from the outside using the key again.

Locking/unlocking the door leaves from the inside



Note:

All door leaves must be unlocked before the bus is driven.

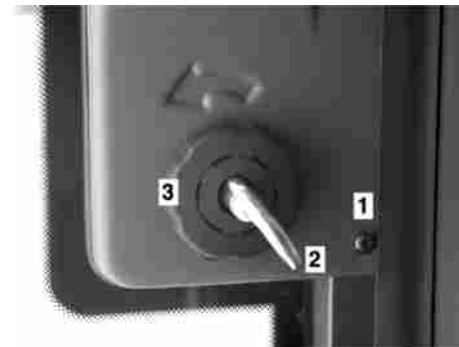

M72_00_0026-01

- ▶ Turn lock (1) with square key (2) in the opposite direction to the arrow. The door is locked.

**Note:**

Square key (2) is the only means of locking the door leaf.

- ▶ Turn lock (1) in the direction of the arrow using square key (2) or handwheel (3).

The door is unlocked.

**Note:**

Handwheel (3) is able only to unlock the door leaf.

Opening/closing the doors from the inside**Note:**

Precondition: Bus stationary, electrical system on.

**Danger.**

Do not drive the bus unless the doors are properly closed.



M54.00-1800-71

- ▶ Press one of pushbuttons (1) to (4).
The relevant door(s) open(s).
The indicator lamp in the pushbutton pressed lights up.

Opening/closing automatic doors from the inside



M54.00-2340-71

The following appears on the display screen: “Drive-off lock/bus stop brake activated” (A). “Door 1 and/or door 2, 3 open” (B).

- ▶ Press one of pushbuttons (1) to (4) again.

The relevant door closes.

The indicator lamp in the pushbutton pressed goes out.

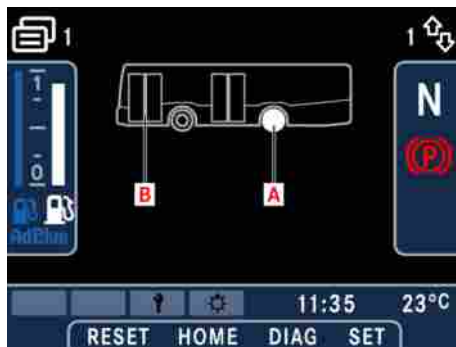

M54.00-2341-71

The following appears on the display screen: “Drive-off lock/bus stop brake activated” (A). “All doors closed” (B).

The bus is ready to depart.

i **Note:**

The drive-off lock is released as soon as the accelerator pedal is depressed and it is possible to pull away.

Opening/closing automatic doors from the inside

i **Note:**

Precondition: Electrical system on, all doors unlocked.

! **Danger.**

Open doors increase the risk of accident for passengers. Do not drive the bus unless the doors are properly closed. Use the door enabling switch for the purpose of opening doors only at bus stops and with the bus stationary.

Opening/closing automatic doors from the inside

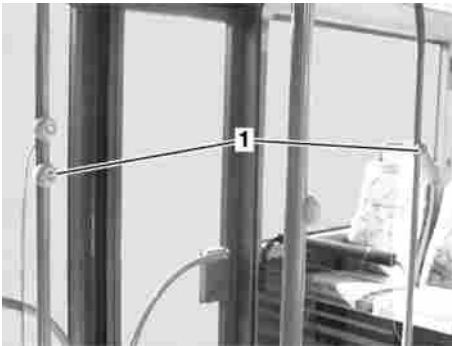

M72_00-0034-01

- ▶ Passenger: Press pushbuttons (1) next to the doors.
A signal sounds.



M82_00-0005-01

- “Bus stopping” (2) or “Stop” on the passenger information screen lights up.



- The following appears on the screen:
“Stop request”.



M54.00-1803-71

- ▶ Driver: Press the lower section of switch (1).
The door opens automatically when switch (1) is pressed.



Note:

The door closes automatically after a hold-open time of approximately 3 seconds. The door can then be reopened by the passenger as often as desired while door enabling switch (1) remains pressed.

Opening/closing automatic doors from the outside



M54.00-2342-71

The following appears on the display screen: “Door open” (C) (door 2 in the example).

Opening/closing automatic doors from the outside



Note:

Precondition: Electrical system on, all doors unlocked.



Danger.

Open doors increase the risk of accident for passengers. Do not drive the bus unless the doors are properly closed. Use the door enabling switch for the purpose of opening doors only at bus stops and with the bus stationary.



M54.00-1803-71

- ▶ Driver: Press the lower section of switch (1).

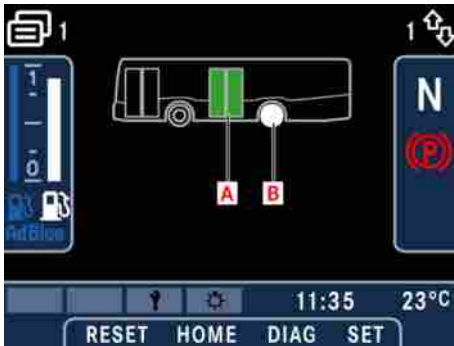

M54.00-2343-71

The following appears on the display screen: “Door enabled” (A) (door 2 in the example) and “Drive-off lock active” (B).

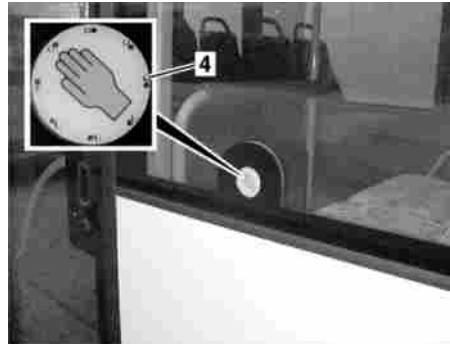

M72_00-0035-01

The green indicator lamps in exterior pushbutton (4) light up and exterior “Open door” pushbuttons (4) are activated (see example).

- ▶ Passenger: Press pushbutton (4).

The door opens.

The indicator lamp in the corresponding door pushbutton in the driver's area lights up.

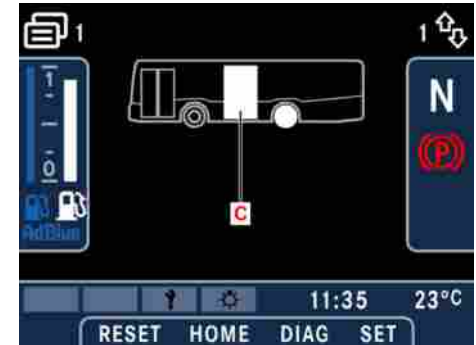

M54.00-2342-71

The following appears on the display screen: “Door open” (C) (door 2 in the example).



Note:

The red indicator lamps in the exterior pushbutton light up briefly if exterior “Open door” pushbutton (4) is pressed.

Opening/closing automatic doors



Note:

The door closes automatically after a hold-open time of approximately 3 seconds.



Note:

The door can be opened as often as desired while the “Door enable” pushbutton remains pressed by the driver (1).



The “Stop request” indication display on the display screen goes out.

Opening/closing automatic doors



Note:

Precondition: Electrical system on, all doors unlocked.



Danger.

Open doors increase the risk of accident for passengers. Do not drive the bus unless the doors are properly closed. Use the door enabling pushbutton for the purpose of opening doors only at bus stops and with the bus stationary.

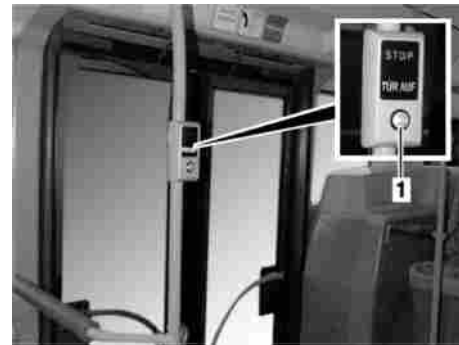

M72_00-0036-01

- ▶ Press pushbuttons (1) next to the doors.

A signal sounds.



M82_00-0005-01

“Bus stopping” (2) or “Stop” on the passenger information screen lights up.



The following appears on the display screen: “Stop request” (flashing).



M54.00-1803-71

► Driver: Press the lower section of switch (1).

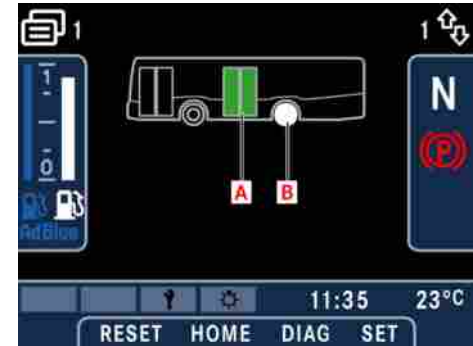

M54.00-2343-71

The following appears on the display screen: “Door enabled” (A) (door 2 in the example) and “Drive-off lock active” (B).

“DOOR OPEN” is displayed in the pushbutton next to the doors.

Opening/closing automatic doors

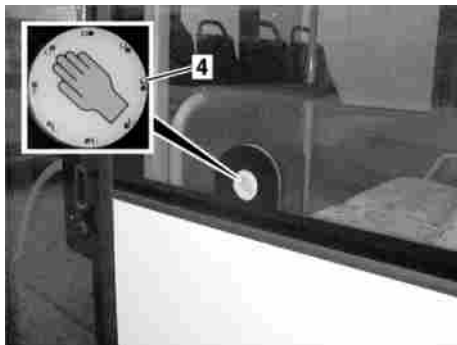

M72_00-0035-01

Exterior pushbuttons (4) are activated and the green indicator lamps in pushbutton (4) light up (see example).

- ▶ Passenger: Press passenger pushbutton (4).

The door opens.

The indicator lamp in the corresponding door pushbutton lights up.

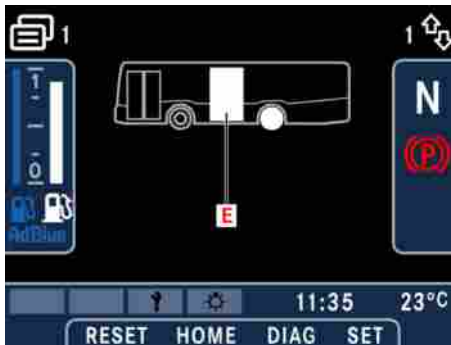

M54.00-2344-71

The following appears on the display screen: “Door open” (E) (door 2 in the example).

Note:

If pushbutton (4) is pressed, the red indicator lamps in the pushbutton light up briefly.

Note:

The door closes automatically after a hold-open time of approximately 3 seconds.

Note:

The door can be opened as often as desired as long as switch (1) remains pressed.



The “Stop request” indication display on the display screen goes out.

Switching between automatic and manual door operation

Switching between automatic and manual door operation

**Note:**

Precondition: Bus stationary, parking brake applied.

**Danger.**

Risk of accident. At door 1, switch (5) is used to deactivate the automatic drive-off lock and not to change the door operating mode between automatic and manual.

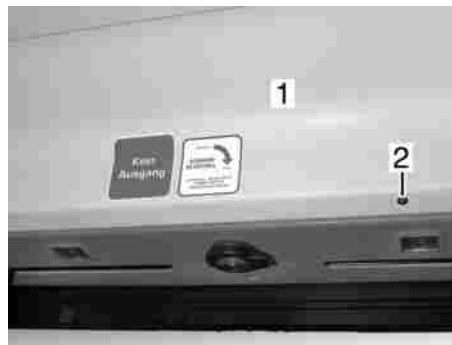

M72_00-0066-01

- ▶ Release (2) and open service cover (1) above the relevant door.

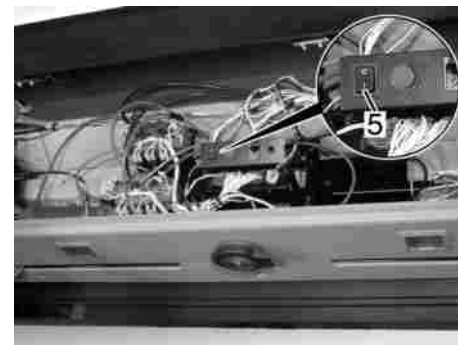

M72_00-0069-01

- ▶ Press switch (5) to position 0.
Automatic operation of relevant door (door 2 or 3) is disabled.
The door cannot be opened by passengers.

Switching between automatic and manual door operation



M54.00-1800-71

It is possible to operate the door manually using the corresponding pushbutton (2/3) on the instrument panel.

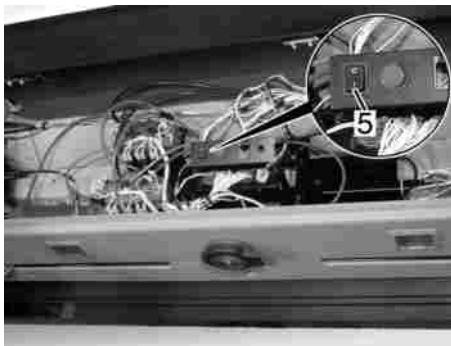

M72_00-0069-01

- ▶ Press switch (5) to position 1.
Automatic operation of relevant door (door 2 or 3) is enabled.
The door can be opened by passengers with the automatic door function enabled.

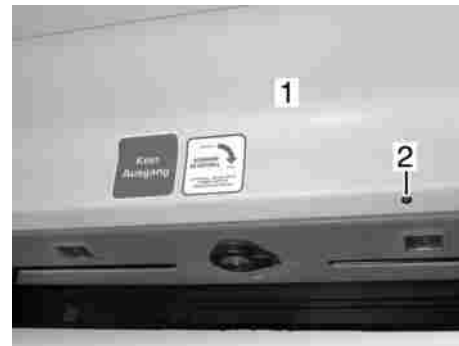

M72_00-0066-01

- ▶ Close and lock (2) service cover (1) above the relevant door.

Teaching in the doors in the closing and opening directions

Teaching in the doors in the closing and opening directions

i Note:

Precondition: Bus stationary, parking brake applied, supply pressure > 7 bar, battery voltage 24 V, on-board power supply on, electrical system on.

i Note:

Teaching-in is not the same as fault correction. If a malfunction recurs after the teach-in process has been completed, the cause of the fault will have to be rectified.

i Note:

Always teach in door 1 first if malfunctions have occurred simultaneously at door 1 and another door.

i Note:

Always teach in doors in both the closing direction and the opening direction.

! Caution:

The control unit at door 1 has programming specific to the bus in which it is fitted. Do not exchange the control units for test purposes.

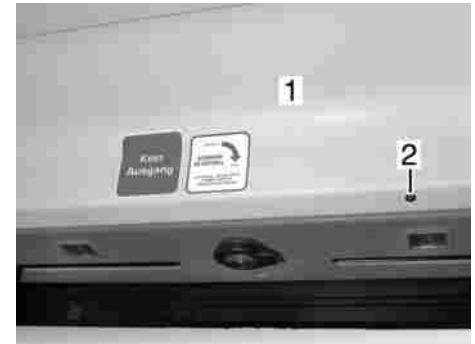

M72_00-0066-01

- Release (2) and open service cover (1) above the relevant door.

Teaching in the doors in the closing and opening directions

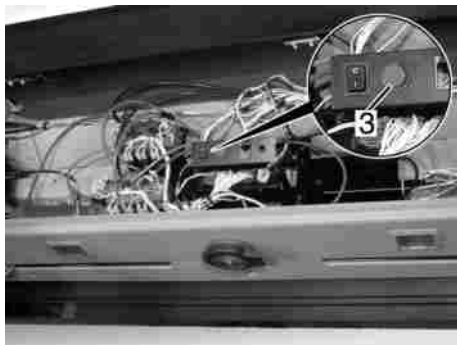

M72_00-0068-01

- ▶ Press and hold workshop pushbutton (3) to teach in the door in the closing direction.

The door closes.

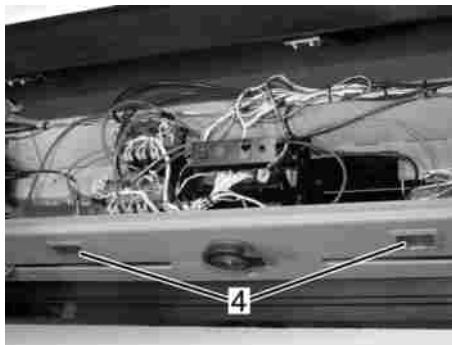

M72_00-0067-01

- ▶ Wait until doorway lamp (4) flashes.



Note:

Flashing indicates that the teach-in process in the closing direction has been completed correctly.



Note:

Doorway lamp (4) flashes once at door 1, twice at door 2 and three times at door 3, etc.

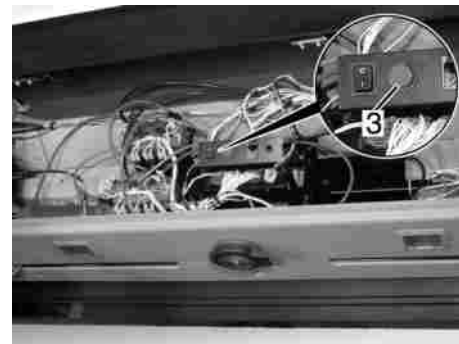

M72_00-0068-01

- ▶ Release workshop pushbutton (3).



Note:

Do not release workshop pushbutton (3) until the flashing sequence is completed (once at door 1, twice at door 2 and three times at door 3, etc.).

Teaching in the doors in the closing and opening directions

The door has been taught in in the closing direction.

- ▶ Press and hold workshop pushbutton (3) to teach in the door in the opening direction.

The door opens.

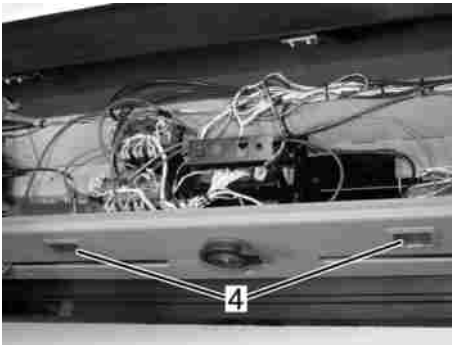

M72_00-0067-01

- ▶ Wait until doorway lamp (4) flashes.

**Note:**

The flashing indicates teach-in in the opening direction has been completed correctly.

**Note:**

Doorway lamp (4) flashes once at door 1, twice at door 2 and three times at door 3, etc.

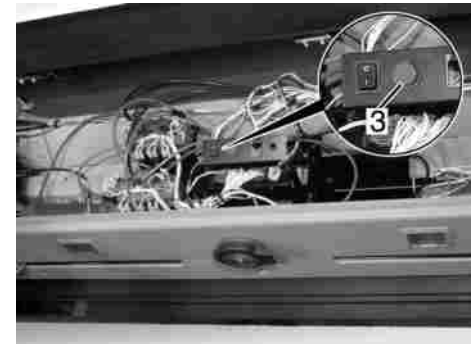

M72_00-0068-01

- ▶ Release workshop pushbutton (3).

**Note:**

Do not release workshop pushbutton (3) until the flashing sequence is completed (once at door 1, twice at door 2 and three times at door 3, etc.).

The door has been taught in in the opening direction.

- ▶ First, switch off the electrical system and then the on-board power supply and wait for approximately 5 seconds.

Pushchair stop request

The newly taught-in values are stored in the control unit.

- ▶ Switch the on-board power supply back on followed by the electrical system.

The door operates with the newly taught-in values.

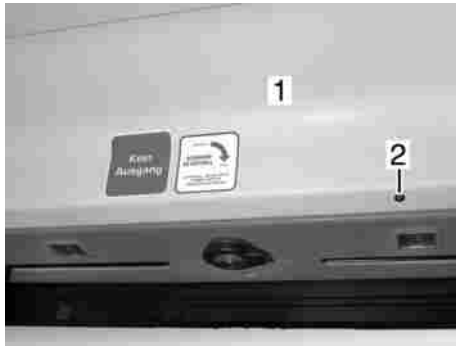

M72_00-0066-01

- ▶ Close and lock (2) service cover (1) above the relevant door.

Pushchair stop request



Note:

Precondition: Door enabled.

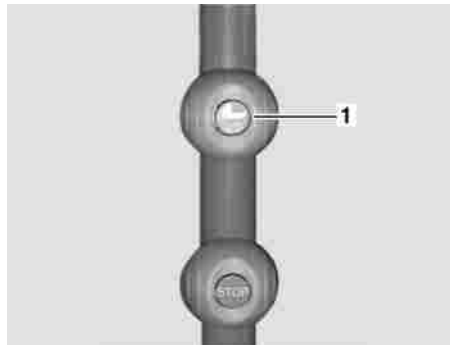

M72_00-0033-01

- ▶ Passenger: Press pushbutton (1).

A signal sounds.



M82_00-0005-01

“Bus stopping” (2) or “Stop” on the passenger information screen lights up.



M54.00-2345-71

The following appears on the display screen: “Stop request” (E), “Pushchair” (B).



M54.00-1809-71

► Driver: Press the lower section of “Pushchair” switch (1).

**Note:**

If the pushchair function is enabled, the door no longer closes automatically but remains open. The door closes only in response to the driver pressing the corresponding pushbutton on the instrument panel.

**Note:**

The pushchair function is also activated when the driver opens the door.



M54.00-2345-71

The following appears on the display screen: “Pushchair” (B), “Door open” (C), “Wheel braked” (D).

The “Stop request” indication display (E) goes out.

Pushchair stop request

- ▶ Driver: Press the upper section of switch (1).



Note:

If the pushchair function is disabled by the driver, the door closes automatically after the hold-open time (approximately 3 seconds). Passengers can now open the door again.



M54.00-2345-71

The “Pushchair” indication display (B) on the display screen goes out.

Note on maintenance work and underbody cleaning	256
Safety precautions for work carried out in the engine compartment	256
Oil level information (option)	257
Checking the engine oil level, topping up if necessary.	259
Operating safety and roadworthiness	260
Tyre pressure	261
On-screen tyre pressure monitor (option)	261
Tyre tread	263
Tyre condition	263
Tyre age	263
Invisible tyre damage	264
Tyre load capacity, top speed of tyres and types of tyres	264
Retreaded tyres	265
Cleaning the tyres	265
Retightening the wheel nuts	265
Wheel nut tightening torques	266

Table of contents

Snow chains	266
Tyre pressures table	268
Safety measures to be taken in the event of a flat tyre or a wheel change	270
Jacking points	270
Jacking points, front	272
Jacking points, centre (articulated buses only)	272
Jacking points, rear	273
Emergency release of the drive-off lock	274
Electrical system safety precautions	275
General safety precautions for batteries	276
Safety precautions for handling batteries	276
Battery maintenance	277
Testing the battery	277
Recharging the batteries	278
Working on the electrical system and electrical fuses	278

Measures required for the prevention of damage to buses or components during electric welding work	279
Switching the on-board power supply on/off	280
Battery isolating switch (with switch-off authorisation LED)	281
Switching the on-board power supply on/off (articulated bus)	282
Switching off the on-board power supply at the master safety switch	283
Jump-starting where vehicle batteries are mounted side by side	284
Jump-starting buses equipped with a battery charging socket	286
Opening the emergency exit in the roof	287
Folding out and folding in headlamps or bumper corner pieces	289

Note on maintenance work and underbody cleaning

Note on maintenance work and underbody cleaning



Note:

All maintenance work is described in a separate manual. For further information, please consult your EvoBus Service Partner.

Safety precautions for work carried out in the engine compartment

Observe the following instructions and information.



Danger.

Never leave the engine running when work is being carried out in the engine compartment.



Danger.

Prevent the engine from being switched on without authorisation. Remove the key from the ignition starter switch.



Danger.

If the engine is at operating temperature, leave it to cool down - risk of burns.

If the bus has broken down and it is necessary to replace a drive belt but no suitable gauge is available for checking the tension of the new belt, drive the bus to the nearest OMNIplus Service

Partner as soon as possible and have the belt tension and tightening torques checked.

Oil level information (option)



M68.00-0426-71

Information about the engine oil level is displayed on display screen (1). To view the oil level information, select the fourth main menu using the main menu buttons on the steering wheel, and then call up the second submenu using the steering wheel's arrow buttons. The oil level information informs you whether the oil level is correct or not.



Note:

Oil level information cannot be called up unless the bus is stationary.



Note:

The oil level cannot be measured until after the engine has been stopped for at least 5 minutes and only with the ignition starter switch in the ON position. The actual oil level is not displayed again until the ignition starter switch has been switched to OFF and back to ON.



Caution:

The bus must be level when the oil level is measured. If the oil level is measured with the bus on an incline, an incorrect oil level will be displayed on the display screen and the red alert may appear on the instrument panel.



Caution:

There is a risk of engine damage if the oil level is too low or too high. For this reason, correct the oil level at the earliest opportunity.



Danger.

Risk of accident. Calling up information manually while the vehicle is in motion will distract you from the road and traffic conditions. This could result in an accident with serious or fatal injuries. Therefore: Do not call up information manually unless the bus is stationary and the parking brake is applied.

Oil level information (option)

Engine oil level OK



M54.00-2346-71

If the engine oil level is within the normal range, this is indicated by “Engine oil level” symbol (1) and “OK” (2).



Note:

If the oil level is OK, it is not possible to call up any further oil level information.

Engine oil level too low



M54.00-2347-71

If the engine oil level is too low, this is indicated by “Engine oil level” symbol (1) and the top-up amount in litres (2) (- 5 litres in this screen display).



Caution:

There is a risk of engine damage if the oil level is too low. For this reason, correct the oil level at the earliest opportunity.

Engine oil level too high



M54.00-2348-71

If the engine oil level is too high, this is indicated by “Engine oil level” symbol (1) and “> MAX” (2).



Caution:

There is a risk of engine damage if the oil level is too high. For this reason, correct the oil level at the earliest opportunity.

Checking the engine oil level, topping up if necessary.

Engine oil level critical



M54.00-2349-71

A red alert appears and red status indicator (1) lights up if the engine oil level has dropped to critical level. If the warning buzzer also sounds, the oil level must be corrected immediately.



Danger.

Risk of accident. In the event of a red alert, the operating safety or roadworthiness of the bus is at risk.

Engine oil level cannot be measured



M54.00-2350-71

If the oil level cannot be measured, e.g. due to a sensor fault, this is indicated by “Engine oil level” symbol (1) and “- - - L” (2). The engine must have been switched off for at least 5 minutes before the engine oil level can be displayed. This display will also appear if the oil level is called up while the vehicle is in motion.

Checking the engine oil level, topping up if necessary.



Note:

Park the bus on horizontal ground.



Danger.

Prevent the engine from being switched on. Remove the key from the ignition starter switch.

Operating safety and roadworthiness

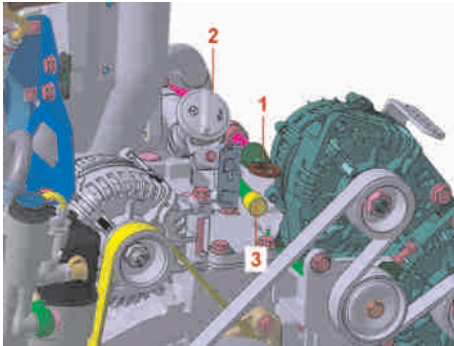

M01.00-0146-71

- ▶ Pull out dipstick (1) with the engine switched off and at normal operating temperature.

i Note:

After you have switched off the engine, wait approximately 10 minutes to allow the oil to collect in the oil sump.

i Note:

The oil level must be visible between the minimum and maximum markings.

- ▶ At filler opening (2), add the top-up volume required in accordance with the Specifications for Service Products.

i Note:

Top up by the amount required as shown on the display screen. Then run the engine for approximately 20 minutes (idling speed or vehicle in motion). The screen display is updated only after this time has elapsed.

! Caution:

Do not confuse oil dipstick tube (1) with oil siphoning point (3).

Operating safety and roadworthiness

Tyres are particularly important for the operating safety and roadworthiness of the bus. The pressure, tread and condition of the tyres should therefore be checked on a regular basis.

Tyre pressure

Check the specified tyre pressure regularly – at least once a week and before longer journeys – when the tyres are cold.

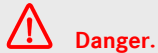

Danger.

Always observe the specified tyre pressures for your bus. The temperature and pressure of the tyres increase when the bus is in motion. For this reason, you should never reduce the pressure of warm tyres. The tyre pressures would then be too low once the tyres had cooled. If the tyre air pressure is too low, the tyre is liable to burst, particularly with increasing numbers of passengers/load and speed. This could result in you losing control of your bus and causing an accident, thereby injuring yourself and other people.



Note:

If the tyre pressure is too low, this leads to intensive heating of the tyres, increased tyre wear, changes in directional stability and increased fuel consumption.



Note:

If the tyre pressure is too high, this results in a longer braking distance, poorer tyre grip and increased tyre wear.



Caution:

Caps on the tyre valves protect the valve inserts from moisture and dirt. The caps on the tyre valves should therefore always be screwed on tightly.

On-screen tyre pressure monitor (option)

The “Tyres” menu window is available in buses equipped with electronic tyre pressure monitoring.

The tyre pressure monitor is a convenience system designed to help you to check tyre pressures regularly and issues a warning if a tyre is overinflated or loses pressure.



Danger.

It is always your responsibility to ensure that the tyres are inflated to the correct pressure.



Note:

Tyre pressure increases or decreases by approximately 0.2 bar with every 10 °C increase or decrease in air temperature respectively. Bear this temperature-related change in tyre pressure in mind if you are checking tyre pressures indoors and the temperature indoors is higher than the temperature outdoors. Example:

On-screen tyre pressure monitor (option)

Room temperature is approximately 20 °C. Outside temperature is approximately 0 °C. In this case, the tyre pressure would be 0.4 bar higher than the value specified in the tyre pressures table.

The tyre pressure monitor monitors the pressure in all tyres while the bus is stationary and while the bus is in motion.



Note:

The warnings issued by the tyre pressure monitor cannot be reliable unless the tyres have been inflated to the correct nominal pressure. The tyre pressure monitor would work with an incorrect value if, for example, your vehicle were overladen or laden incorrectly or if you were to fit wheels with a different tyre size to the vehicle and did not correct the nominal pressure in the on-board computer or entered an incorrect value. Refer to the tyre pressures table to check that the nominal pressure has been set correctly. An underinflated tyre would lead to instability while the bus is in motion and therefore an increased risk of accident. Have the correct nominal pressure set in

the on-board computer at a qualified specialist workshop.



Note:

If radio transmitting equipment (e.g. radio headphones, two-way radios) is being operated inside the bus or nearby, this could interfere with the correct functioning of the tyre pressure monitor. The display screen in the instrument cluster displays “- -” in place of the respective tyre pressure if a tyre pressure sensor is temporarily suffering interference, e.g. from radio transmitting equipment, or if the tyre pressure sensor has not yet supplied any values. Wait a few minutes and/or drive the vehicle away from the area affected by the radio transmitting equipment. The tyre pressure values shown on the display screen may differ from the readings obtained with an air pressure gauge. The tyre pressure displayed by the on-board computer relate to sea level. At higher locations, air pressure gauges display a higher tyre pressure than the display screen does. Do not reduce tyre pressure in this situation. The tyre pressure monitor detects new wheels or new

tyre pressure sensors automatically. Drive the bus for a few minutes at a speed of over approximately 18 mph (30 km/h).

Tyre tread

A minimum tyre tread depth is specified by law. Comply with the legal specifications for the relevant country.

As the remaining tread depth reduces, the less effective the road grip and handling characteristics of the bus become, particularly on wet or snowy roads.

In the interest of safety, have the tyres replaced before the legally-specified minimum tread depth is reached.

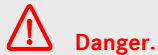

Danger.

Always ensure that there is sufficient tyre tread. Insufficient tyre tread depth increases the risk of aquaplaning if the bus is driven at high speed during heavy rain or in slush. The tyre tread can no longer deflect the water away. This could result in you losing control of your bus and causing an accident, thereby injuring yourself and other people.

Tyre condition

Before setting off, check the tyres on the bus for:

- external signs of damage
- foreign objects in the tyre tread
- foreign objects between twin tyres
- cracks, bulges



Note:

Please note that cracks, bulges or external damage can cause a tyre to burst. This could result in you losing control of the bus and causing an accident, thereby injuring yourself and other people. Have damaged tyres replaced immediately.

Tyre age

Have the tyres changed at least every six years, irrespective of wear. This also applies for the spare wheel.



Danger.

The sun's rays and environmental factors cause tyres to age. The rubber from which the tyre is made loses elasticity. Tyres harden and become brittle, cracks appear due to ageing. Tyres which are more than six years old are no longer reliable.

Invisible tyre damage

Invisible tyre damage

Avoid crushing tyres against the kerb or switching off the bus when a part of the tyre tread is up on the kerb.



Danger.

Driving over the edge of the kerb or sharp edged objects can cause damage to the tyre substructure which is not visible externally. Damage to the tyre substructure only becomes noticeable much later and could cause the tyre to burst. This could result in you losing control of your bus and causing an accident, thereby injuring yourself and other people.

Tyre load capacity, top speed of tyres and types of tyres



Danger.

Exceeding the specified tyre load capacity or the approved maximum tyre speed could lead to tyre damage or tyre failure. You could then lose control of your bus and cause an accident, which could result in injury to yourself and others. For this reason, use only the tyre types and sizes approved for your bus model and observe the required tyre load capacity and speed index for your bus. Pay particular attention to country-specific tyre approval regulations. These regulations may specify a particular type of tyre for your bus or prohibit the use of particular tyre types that may be approved in other countries. In addition, it may be advisable to use a specific type of tyre in certain regions or areas of use. You can obtain information on tyres from any OMNIplus Service Partner.

meter, otherwise the tyre that has the largest diameter will be overloaded. Tip: the simplest and most reliable measurement method is to check circumferences using a circumference tape.



Note:

The maximum tolerance for twin tyres is 0.5% of the tyre diameter. The larger tyre must always be fitted in the outboard position.

Where twin tyres are fitted, the twin tyres must have the same external dia-

Retreaded tyres

It is advisable to use only tyres and wheels that EvoBus has tested and approved specifically for your vehicle.

Cleaning the tyres



Danger.

Risk of accident. Clean tyres and suspension air bags very carefully. Round-spray jets must not be used to clean the tyres and suspension air bags. The water jet may damage the tyres. Replace damaged tyres.



Environmental protection

Damage to the environment: only clean the bus at a washpoint intended for this purpose. Heed environmental protection measures.

Retightening the wheel nuts



Danger.

Risk of accident. Regularly check the wheel nuts for firm seating and retighten if necessary. Whenever a new wheel has been fitted or the wheel has been changed, the wheel nuts on the newly fitted wheel must be retightened after a distance of 30 miles (50 km). Observe the tightening torques.

Wheel nut tightening torques

Wheel nut tightening torques

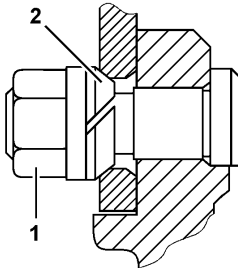

M40_10-0001-01



Danger.

Risk of accident. Observe the tightening torques: pressed-steel wheel with centring by spherical spring washers (2) and wheel bolts 450 Nm.

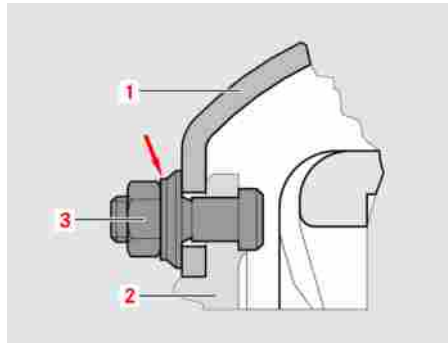

M40_00-0016-01



Danger.

Risk of accident. Observe the tightening torques: pressed-steel wheel with hub centring by wheel hub 600 Nm. Light-alloy wheel with hub centring 600 Nm.

Snow chains

Fitting snow chains



Caution:

Snow chains must not be fitted to the wheels on the front axle or centre axle.



Note:

Comply with the manufacturer's fitting instructions and legal requirements.



Note:

Only fine-link snow chains are permitted.



Note:

Raising the bus using the raising/lowering system may make it easier to fit the snow chains.



Danger.

Make sure that the snow chains are fitted tightly. Do not exceed the maximum permissible speed of 40 km/h.













Note:

Check the snow chains for firm seating after you have driven a certain distance (dependent on prevailing conditions) and retighten them if necessary.

Tyre pressures table

Tyre pressures table

	[bar]	5,5	5,75	6,0	6,25	6,5	6,75	7,0	7,25	7,5	7,75	8,0	8,25	8,5	8,75	9,0
		4980	5060	5240	5410	5580	5760	5930	6090	6260	6340	6590	6760	6920	7080	7250
		9000	9320	9650	9970	10280	10600	10910	11220	11530	11840	12140	12440	12740	13040	13340
		4670	4840	5010	5180	5340	5510	5670	5830	5990	6150	6310	6460	6620	6780	6930
		8610	8920	9230	9530	9840	10140	10440	10730	11030	11320	11610	11900	12190	12480	12760
		4240	4400	4550	4710	4850	5010	5150	5300	5440	5590	5730	5870	6020	6160	6300
		7820	8110	8390	8660	8940	9220	9490	9760	10030	10290	10550	10820	11080	11340	11600
 275 / 70 R 22,5																

[bar]

Tyre pressure in bar



Axle load/tyre pressure rating for excursions and touring services



Tyre size 275/70 R 22.5, load index 148



Axle load for single tyres in kg



Axle load for twin tyres in kg



Axle load/tyre pressure rating for public transit buses operated in urban traffic, including journeys involving longer distance routes, e.g. in order to service suburbs and neighbouring towns, provided the average speed does not exceed 40 km/h



Axle load/tyre pressure rating for public transit buses required to operate at road speeds up to a maximum of 60 km/h



Danger:

Risk of accident. An under-inflated tyre impairs driving safety and reduces tyre life. Fuel consumption, tyre wear and risk of tyre damage are increased.



Caution:

Check tyre pressures regularly.



Note:

The values listed in the table are recommended values for tyre size 275/70 R 22.5 - load index 148. For specific or unusual operating conditions, please contact the tyre manufacturer concerned.



Note:

Tyre pressure increases or decreases by approximately 0.2 bar with every 10 °C increase or decrease in air temperature respectively. This must be borne in mind if tyre pressures are checked indoors, especially in the winter.

Example: temperature in the depot approximately 20 °C, outside temperature approximately 0 °C - this means that the tyre pressure to be set = specified tyre pressure + 0.4 bar.

Safety measures to be taken in the event of a flat tyre or a wheel change

Safety measures to be taken in the event of a flat tyre or a wheel change



Danger.

Park the bus as far away as possible from the traffic and on firm ground. Switch on the hazard warning lamps. Let all passengers disembark and move them out of the danger zone (e.g. behind the crash barrier). Position a warning triangle or hazard warning light at a suitable distance. Observe the legal requirements of the country concerned.

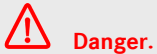

Danger.

Only change the wheel on a level, firm and non-slip surface. The bus or jack may slip out to the side on a soft or slippery surface (snow, ice, smooth surface, etc.).



Danger.

Never lie under the bus if it is raised up and is not supported by axle stands. Do not start the engine as there is a risk of fatal injury. Safeguard the engine against being switched on without authorisation. Remove the key from the ignition switch.

Jacking points



Danger.

Risk of accident. Secure the bus against rolling away.



Danger.

Risk of accident. Observe the operating instructions issued by the jack manufacturer.



Danger.

Risk of accident. Never lie under the bus if it has been raised without the additional support of axle stands. Do not start the engine as there is a risk of fatal injury. Prevent the engine from being switched on without authorisation, remove the key from the ignition starter switch.



Danger.

Risk of accident. If the complete bus is to be raised using wheel grippers, multi-post lifts, etc., all axles must be raised simultaneously.



Danger.

Risk of accident. For safety reasons, switch off the on-board power supply.



Caution:

When the bus is being lowered, make sure that the suspension air bags are seated correctly and that there is sufficient supply pressure to fill the suspension air bags again.



Caution:

The driven axle and centre axle must never be raised in the middle.



Caution:

The driven axle and trailing axle are interconnected by the suspension. It is prohibited to raise an individual axle to such a height that the wheels on the second axle would be lifted from the ground.



Note:

The whole bus can be raised using the jacking points on the underbody.

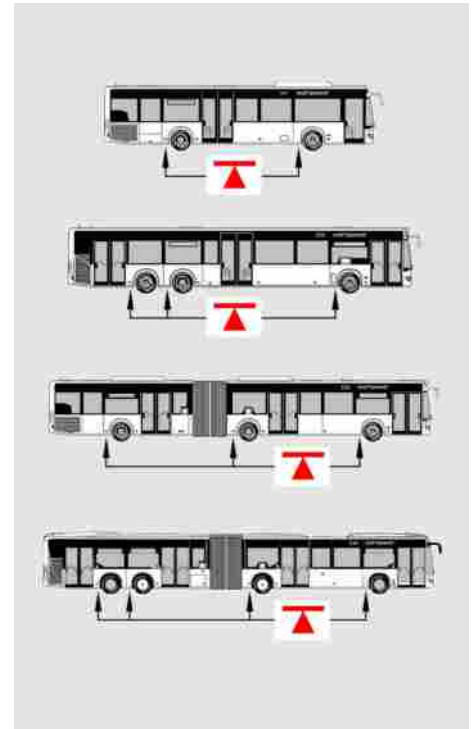

M00_00-0529-73

Jacking points, front

- ▶ Raise the bus at the designated jacking points indicated on the underbody of the bus.

Jacking points, front



Danger.

Secure the bus against rolling away. Apply the parking brake.

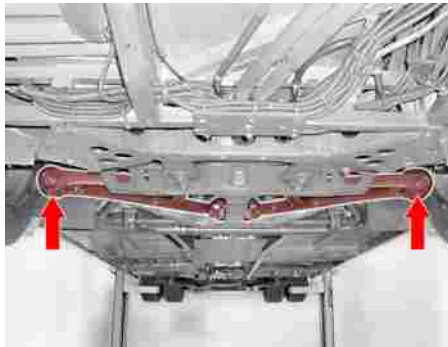

M40_00-0075-71

- ▶ Raise the bus at the jacking points on the front axle casing shown in the illustration.

Jacking points, centre (articulated buses only)



Danger.

Secure the bus against rolling away. Apply the parking brake and chock the front wheels.

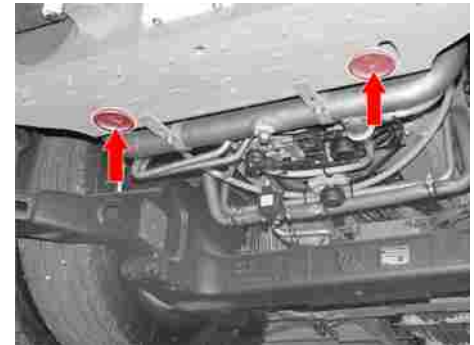

M00_00-0533-01

- ▶ Raise the bus at the jacking points at the centre of the bus underbody shown in the illustration.

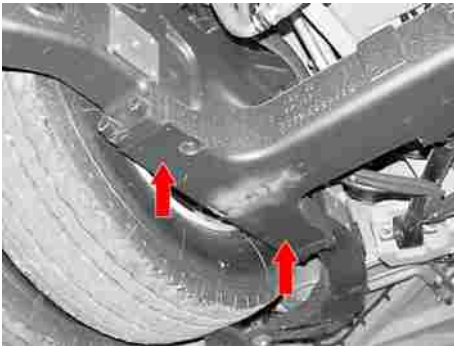

M00_00-0534-01

- ▶ Raise the bus at the jacking points on the centre axle shown in the illustration.



Caution:

Never position the jack at the centre of the axle casing.

Jacking points, rear



Danger.

Secure the bus against rolling away. Apply the parking brake and chock the front wheels.

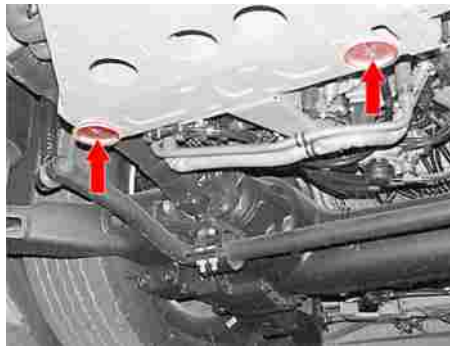

M00_00-0530-01

- ▶ Raise the bus at the jacking points at the rear of the bus underbody shown in the illustration.

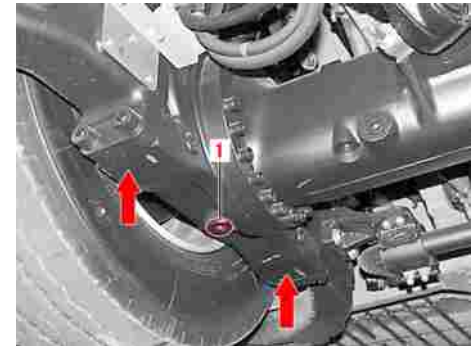

M00_00-0531-01

- ▶ Raise the bus at the jacking points on the rear axle shown in the illustration.



Caution:

Never position the jack against oil drain plug (1) or in the centre of the axle casing.

Emergency release of the drive-off lock

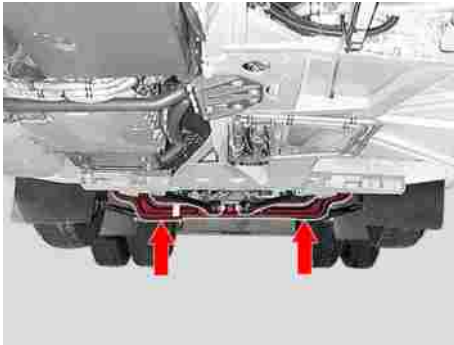

M00_00-0532-01

- ▶ Raise the bus at the jacking points on the trailing axle shown in the illustration.



Caution:

The driven axle and trailing axle are interconnected by the suspension. It is prohibited to raise an individual axle to such a height that the wheels on the second axle would be lifted from the ground.

Emergency release of the drive-off lock



Danger.

This switch has a tamper-evident seal and is intended to be operated only in the event of a malfunction in the bus stop brake or drive-off lock.



Danger.

Make absolutely sure that the parking brake is applied before you operate the bus stop brake emergency release switch. The bus could otherwise roll away.

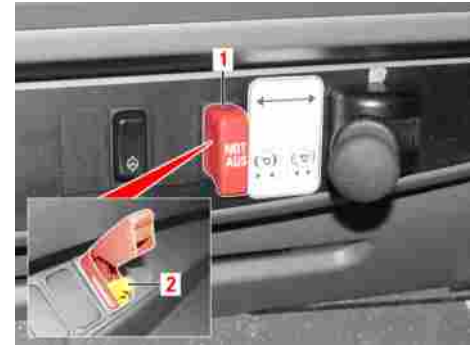

M54.00-1821-71

- ▶ Remove tamper-evident seal (1).
- ▶ Open switch cover (2).
- ▶ Pull switch (2).

The drive-off lock is released.

A signal sounds with the bus stationary.

Electrical system safety precautions



M54.00-2351-71

Yellow status indicator (1) lights up with the bus stationary.



The “Brake” symbol and the “Störung Haltestellenbremse” (Bus stop brake malfunction) message are displayed on the screen.



Danger.

Have the malfunction rectified as soon as possible by an OMNIplus Service Partner.

Electrical system safety precautions

For safety reasons, always switch off the battery isolating switch before work is carried out on the electrical system or the batteries are disconnected/reconnected.

Do not connect or disconnect wiring harness connectors to/from electronic control units unless the ignition starter switch is OFF.

During engine washes, always protect the starter, alternator and electrical plug connections from moisture.

Never attempt to bridge or repair fuses. Use only fuses of the specified amperage. Never replace fuses with those of a higher ampere rating as this could lead to damage to the electrical system.

General safety precautions for batteries

General safety precautions for batteries



Danger.

Risk of short circuit. Do not place any metal objects on batteries.



Caution:

Do not loosen or disconnect the terminal clamps while the engine is running and electrical consumers are switched on.



Environmental protection

Dispose of defective batteries in an environmentally responsible manner. Observe legal requirements.

Safety precautions for handling batteries



M54_10-0004-01

(1) - Fire, sparks, naked flames and smoking are prohibited. Prevent sparking.

(2) - Risk of explosion.

(3) - Observe the operating instructions.

(4) - Risk of acid burns. Battery acid is corrosive. Always observe the safety instructions and safety precautions when handling batteries or battery acid. Battery acid must never come into contact with skin, eyes or clothing. Rinse off all acid splashes immediately with copious

amounts of clean water. Seek medical attention if necessary.

(5) - Wear safety goggles.

(6) - Keep children away.



Danger.

Naked flames and smoking are strictly prohibited whenever work is being carried out on the vehicle batteries. Avoid the creation of sparks. Wear safety goggles. Keep children away. There is a risk of acid burns. The Operating Instructions must be observed. There may be a risk of explosion.



Danger.

All cells of lead-acid batteries must be fitted with special caps that are interlinked by vent hoses, thereby allowing any gases produced to be directed into the open air.

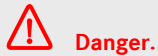

Danger.

If the bus is equipped with lead-acid batteries, it is prohibited to exchange these for gel batteries, and vice versa.

Battery maintenance

- Do not clean the batteries without the cell caps screwed in. Do not use petrol, benzene, kerosene or similar for cleaning.
- Ventilation bores in the cell caps must be open, i.e. the hoses in the cell ventilation must not be blocked.
- Lightly grease the terminal clamps with acid-proof grease, especially the underside.
- Check the securing screws for the terminal clamps and the screw securing the negative cable to the chassis regularly for firm seating.
- Recharge out-of-service batteries once a month or trickle-charge them at 0.06 A. Gel batteries require special chargers having the appropriate charge characteristic (IU, IUOU or WUOU).

Testing the battery



M58.40-0040-71

Connect the battery tester to the battery and refer to the instruction manual.



Note:

Ensure correct connection.

Recharging the batteries

Recharging the batteries



Danger.

Risk of injury. Risk of explosion.

Risk of explosion due to oxyhydrogen gas formation. Make sure that there is good ventilation when you charge the batteries.



Caution:

Caution. Do not rapid-charge new batteries under any circumstances.

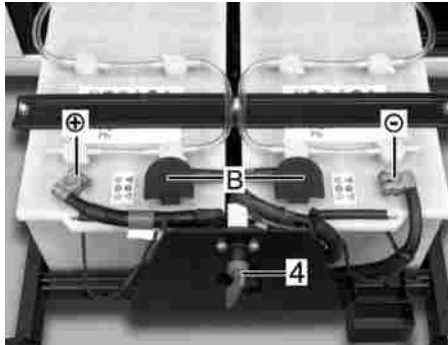

M54_00-0686-01

- Remove the cell caps and terminal clamps from the batteries before recharging. Do not disconnect the connecting cable (B) between the batteries.
- Observe the correct charging voltage (24 volts).
- The charge current should not exceed 10 % of the battery capacity.
- Gel batteries require special chargers having the appropriate charge characteristic (IU, IUOU or WUOU).

Working on the electrical system and electrical fuses



Danger.

Risk of fire.

- Before any work is carried out on the electrical system, switch off all consumers and disconnect the negative terminal clamps (-) of the batteries.
- Do not reconnect the negative terminal clamps (-) until all electrical lines have been reconnected correctly.
- Before you attempt to change a fuse, switch off all consumers and disconnect the negative terminal clamps (-) of the batteries.
- Never attempt to bridge or repair fuses.
- Use only fuses of the specified amperage. Never replace fuses with those of a higher ampere rating as

Measures required for the prevention of damage to buses or components during electric welding work

this could lead to damage to the electrical system.

- Always rectify the cause of the malfunction before replacing the fuse concerned.

Measures required for the prevention of damage to buses or components during electric welding work

To prevent damage to various components of the bus, the following measures must be taken before welding work is carried out:

- Have a fire extinguisher on standby.
- The clip on the negative terminal of the battery must be disconnected and the negative terminal covered. (Observe the notes on disconnecting the vehicle batteries.)
- The pieces of foam fitted in some of the cavities in the body as sound-proofing must be removed before the commencement of panel work, welding and tin-plating.
- Connect the earth connection of the electric welder directly to the part to be welded. When doing so, make sure that there are no electrically insulating parts between the earth connection and the weld point.
- Heat-sensitive parts, such as plastic tubes, are to be protected or removed.
- Lines routed in cavities, and containers or electronic components that have been fitted concealed, must be removed from the danger area before the start of welding.
- The passenger compartment and glazing must be covered with protective mats to protect them from weld splatter and flying sparks.
- Shield off areas at risk of damage caused by flying sparks and radiant heat.
- Do not allow electronics housings or electrical lines to come into contact with the welding electrode or the earth connection of the welder.
- If two parts are to be welded together, both parts must be connected to the negative clip of the welder.
- The seam points of the part on the bus to be welded and of the earth terminal on the electric welder must be as bare as possible – paint, cor-

Switching the on-board power supply on/off

rosion, oil, grease and dirt should therefore be thoroughly removed.

- The earth terminal of the welder must not be connected to the transmission. The welding current may cause sparking at the bearing points inside the transmission. The resultant changes in crystalline structure would lead to premature failure of the assembly.



Danger.

The heating effects may cause dense smoke or fires.

Switching the on-board power supply on/off



Note:

Precondition: Battery voltage 24 ± 3 volts



M54.00-1824-71

- ▶ Open service cover (1) on the battery compartment.



Note:

The batteries (all bus models except articulated bus) are located under the driver's area.



Note:

The battery compartment contains the following: batteries, battery isolating switch and test connections.

Battery isolating switch (with switch-off authorisation LED)

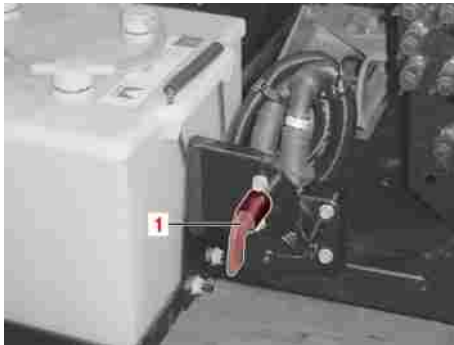

M54.00-1825-71

- ▶ Insert key (1) and turn clockwise.

The electrical systems and consumers are connected to the batteries.

The on-board power supply is switched on.

- ▶ Turn key (1) anti-clockwise and remove.

The electrical systems and consumers are isolated from the batteries.

The on-board power supply is switched off.

Battery isolating switch (with switch-off authorisation LED)

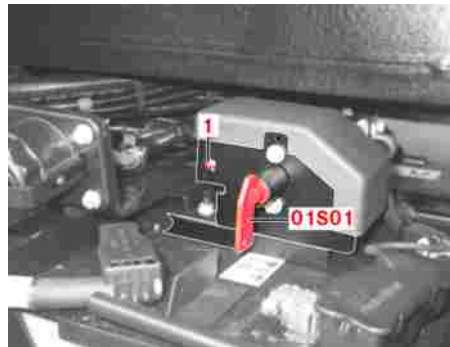

M54.00-2376-71.tif



Caution:

If LED (1) is lit, it is prohibited to turn the battery isolating switch to the "OFF" position. Otherwise, the exhaust gas aftertreatment system could be damaged.



Note:

Battery isolating switch (01S01) is located in the battery compartment.

01S01 Battery isolating switch
Switch-off authorisation LED (1)

Switching the on-board power supply on/off (articulated bus)

Switching the on-board power supply on/off (articulated bus)



Precondition: Battery voltage 24 ± 3 volts



M54.00-2358-71

- ▶ Open the service cover on the battery compartment.



The sticker identifies the battery compartment.



The battery compartment contains the following: batteries, battery isolating switch and test connections.

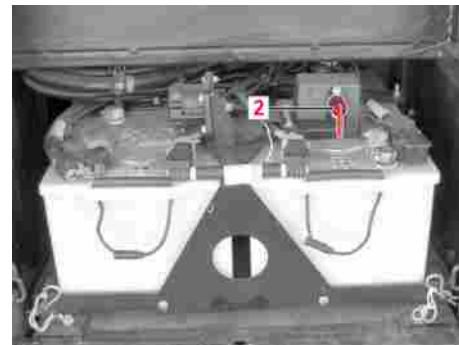

M54.00-1899-71

- ▶ Insert key (2) and turn clockwise.
The electrical systems and consumers are connected to the batteries.
The on-board power supply is switched on.
- ▶ Turn key (2) anti-clockwise and remove.
The electrical systems and consumers are isolated from the batteries.
The on-board power supply is switched off.

Switching off the on-board power supply at the master safety switch

Switching off the on-board power supply at the master safety switch

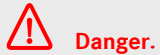

Danger.

Do not operate master safety switch (2) except in an emergency and only with the bus stationary.

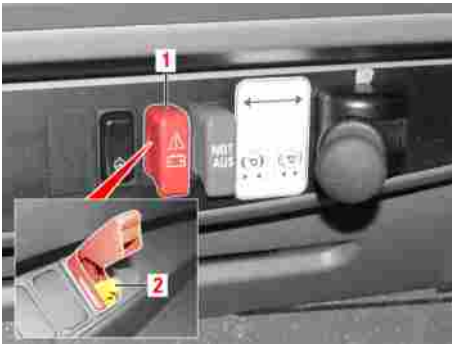

M54.00-1822-71

- ▶ Remove tamper-evident seal (1).
- ▶ Open switch cover (2).

- ▶ Pull switch (2).

The power supply is disconnected.



Note:

All the consumers are isolated from the batteries. Exception: Hazard warning lamps with indicator, tachograph and emergency lighting

The engine stops.



Note:

Switch off the master safety switch before starting up the bus.



Note:

Provide the cover with a new tamper-evident seal and secure it with wire.



Note:

Test regularly.

Jump-starting where vehicle batteries are mounted side by side

Jump-starting where vehicle batteries are mounted side by side



Danger.

Risk of accident. Secure the bus against rolling away.

- ▶ Turn the key in the ignition starter switch back to the stop (position "0").



M54.00-2357-71

- ▶ Open the flap.



Note:

Sticker (1) identifies the battery compartment.



M54_00-0684-01

- ▶ Pull out spring pin (2) on the battery support frame.

Jump-starting where vehicle batteries are mounted side by side

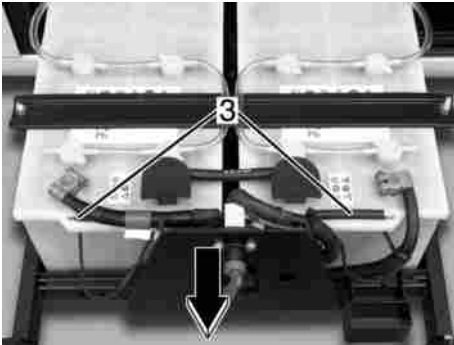

M54_00-0685-01

- ▶ Pull the batteries out on the support frame by gripping handles (3) with both hands.
- ▶ Connect one end of the positive cable to the (+) terminal of the discharged battery first, then connect the other end of the positive cable to the (+) terminal of the donor battery.

- ▶ Connect the negative cable to the (-) terminal on the donor battery and then the other end to an earthed, bare metal part connected to the skeleton of the bus being jump-started.

i Note:

Make the connection as far as possible from the discharged battery.

- ▶ Run the engine of the donor vehicle at an elevated idling speed.
- ▶ Start the engine of the bus to be jump-started in the normal way and let it run at idling speed.
- ▶ Switch off the engine of the donor vehicle.

- ▶ Fully disconnect the negative/earth connection of the jump leads and then disconnect the positive cable.

i Note:

To prevent voltage peaks, switch on the more powerful consumers of the jump-started bus, such as the lighting, heated windows or ventilation, before you disconnect the jump leads.

Jump-starting buses equipped with a battery charging socket

Jump-starting buses equipped with a battery charging socket



Danger.

Risk of accident. Secure the bus against rolling away.

- ▶ Turn the key in the ignition starter switch back to the stop (position "0").



M54.00-2357-71

- ▶ Open the flap.



Note:

Sticker (1) identifies the battery compartment.

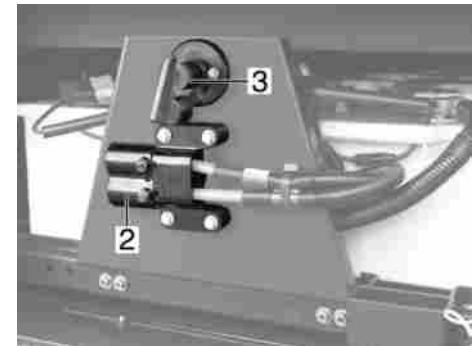

M54_00-0693-01

- ▶ Connect a suitable jump lead to battery charging socket (2).



Note:

Example illustrated: Manufactured by Fenwick

Opening the emergency exit in the roof

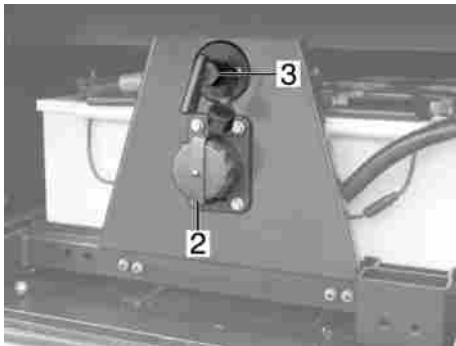

M54_00-0694-01

- ▶ Connect a suitable jump lead to battery charging socket (2).

i Note:

Example illustrated: Nato socket

- ▶ Run the engine of the donor vehicle at an elevated idling speed.
- ▶ Start the engine of the bus to be jump-started in the normal way and let it run at idling speed.

- ▶ Switch off the engine of the donor vehicle.
- ▶ Disconnect the jump lead.

i Note:

To prevent voltage peaks, switch on the more powerful consumers of the jump-started bus, such as the lighting, heated windows or ventilation, before you disconnect the jump lead.

Opening the emergency exit in the roof

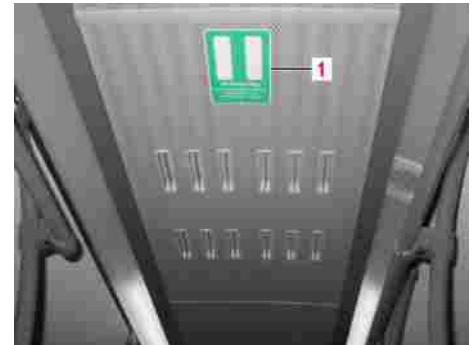

M77.00-0028-71.tif

- ▶ Press in security foil (1).
Behind the security foil is a handle.
Roof plate (2) can be removed using handle (3).

Opening the emergency exit in the roof

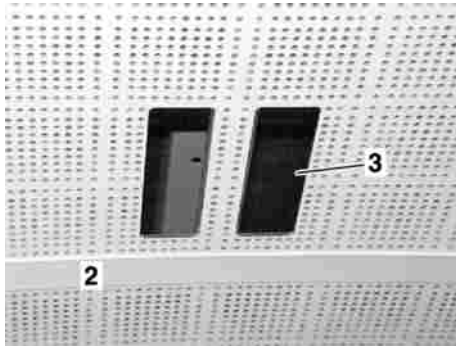

M77_00-0002-01

- ▶ Remove roof plate (2) using handle (3).



Danger.

Risk of accident. Only remove the roof plate or operate the emergency exit in an emergency and with the bus stationary.



M77_00-0014-01

- ▶ Emergency operation is initiated by means of a red interior or exterior twist handle (1).



Note:

In emergencies, interior twist handle (1) must be turned in the direction of the arrow (clockwise). The emergency exit cover can now be secured by a safety rope and placed to one side outside the bus.



Danger.

Following emergency operation of an emergency exit roof hatch, it is necessary to have the cover fitted by specialist personnel at an OMNIplus Service Partner.

- ▶ On an articulated bus, an emergency hammer is located in the roof of the rear car underneath the emergency exit cover. In an emergency, the hammer can be used to break the glass panel in the emergency exit.



Danger.

Risk of injury. There is a risk of injury from flying glass splinters when smashing the window with the emergency hammer. Protect your hands and eyes.

Folding out and folding in headlamps or bumper corner pieces



Danger.

Risk of injury. There is a risk of cutting yourself. Take care when leaving the vehicle through a smashed window.

Folding out and folding in headlamps or bumper corner pieces



Note:

Preconditions: bus secured against moving off of its own accord, front flap open.

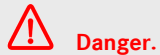

Danger.

The bus must not be moved if a bumper corner piece has been unlocked or folded out.



M88_20-0001-01

- ▶ Move the lever (arrowed) on the rear of the flap lock to the left.



Note:

The direction of movement “to the left” (when viewed in the direction of travel) applies to both bumper corner pieces.

Folding out and folding in headlamps or bumper corner pieces



Note:

The bumper corner piece is additionally secured by a quick-release lock.

- ▶ Grasp the bumper corner piece above the headlamp and pull it in the direction of the arrow against the resistance of the quick-release lock.



Note:

The direction of the arrow signifies: forwards and diagonally away from the centre of the vehicle.



Note:

The fold angle is limited to approximately 60° by a retention strap.

- ▶ To fold the bumper corner piece in, lift it up and push it against the flap lock.



Caution:

Before the bumper corner piece is folded in, make sure that the closing tongue in the quick-release lock is correctly positioned and correct if necessary.



Danger.

Risk of accident if the bumper corner piece folds out of its own accord. Both the quick-release lock and the flap lock must be heard or felt to lock into place. If necessary, check that the flap lock is correctly seated by gently pulling or jogging the bumper corner piece in the same direction as when folding it out.

Vehicle data **292**

Vehicle data

Vehicle data	
Designation	Value
Vehicle length	CITARO:
Bumper-to-bumper length	12,105 mm CITARO G: 18,095 mm
Vehicle width Production version	2,550 mm
Vehicle height without roof-mounted fittings	2,871 mm
Vehicle height with roof-mounted fittings fitted as standard	3,009 mm
Vehicle height with air-conditioning system	3,130 mm
Technically permissible gross vehicle weight	CITARO: 19,000 kg CITARO G: 29,000 kg

Designation	Value
Permissible gross ski holder load	CITARO K: max. 500 kg
Track width, front axle	2,119 mm
Track width, centre axle (CITARO G)	1,834 mm
Track width, driven axle	1,834 mm
Wheel base 1st to 2nd axle	CITARO: 5,900 mm CITARO G: 5,900 mm
Wheel base 2nd to 3rd axle	CITARO G: 5,990 mm
Turning circle (k to k)	CITARO: 17,058 mm CITARO G: 19,160 mm

Designation	Value
Turning circle (w to w)	CITARO: 21,214 mm CITARO G: 22,970 mm
Front overhang	2,805 mm
Rear overhang	CITARO: 3,400 mm CITARO G: 3,400 mm
Angle of approach	7°
Angle of departure	7°
Pitch angle (CITARO G)	-10° ... 10°
Total fuel tank volume	CITARO: approx. 280 l CITARO G: approx. 300 l

Designation	Value
AdBlue additive tank volume	CITARO: approx. 38 l CITARO G: approx. 46 l
Heating-oil tank capacity (option)	CITARO: approx. 50 l CITARO G: approx. 50 l
Windscreen washer reservoir	approx. 20 l

2

230/400 V systems (option)

Safety precautions 62

A

Acceleration skid control (ASR)

Activating/deactivating 37

Accident data recorder (ADR)

Function description 62-63

AdBlue®

Service product 43-44, 50-51

Air-conditioning system

Operating instructions 195

Safety precautions 195

Anti-jackknifing protection

During forward travel 64

During reverse travel 65

Automatic transmission

General 186

Selector positions of the 3-
pushbutton switch panel ... 188-189

Selector positions of the 6-
pushbutton switch panel ... 190-192

Auxiliary heating

Safety precautions 9-10

B

Batteries

Care 277

Recharging 278

Safety precautions 276

BlueTec® exhaust gas cleaning

system 49

Brakes with anti-locking protec-

tion 30

Braking and stopping

..... 29

Bus stop brake

Activating/deactivating 170

C

Care and cleaning

Covers and upholstery 79

Fabric covers 79-80

Safety precautions 76

Tilting a rear seat 77

D

Departure check

Daily tasks 12

Weekly tasks 13

DIAG

Button 150

Diesel particulate filter

Important information 54-55

Regeneration 56-57

Dimmer

Button 155-157

Display brightness

Daytime brightness 155

Night brightness 156-157

Display screen

Description 125

Display screen menu control

logic 136-137

Doors

Emergency operation 230-231

Forced door closure in an
emergency 232-233

Locking door 1 with the key
(option) 236

Locking/unlocking door leaves
from the outside 235

Locking/unlocking the door
leaves from the inside 236

Opening/closing automatic
doors - code T51 242-244

Opening/closing automatic doors from the inside 238-239

Opening/closing automatic doors from the outside 240-241

Opening/closing door 1 from the outside 234

Opening/closing the doors from the inside 237

Protection against entrapment in the door closing direction 228

Protection against entrapment in the door opening direction 228

Switching between automatic and manual door operation 245-246

Teaching in the doors in the closing and opening directions 247-249

Drive-off lock 171

Emergency release 274

Driver's area

Overview 88

Driver's area side compartment

Driver's area side compartment 94-97

Driver's seat

Grammer MSG 90.5 182-183

Driver's window

Opening/closing 175

Driving 22

E

Electric ramp

Retracting/extending the electric ramp (option) 71-74

Electrical system 278

Measures required for the prevention of damage 279

Safety precautions 275

Switching off the on-board power supply at the master safety switch 283

Switching the on-board power supply on/off 280-281

Switching the on-board power supply on/off (articulated bus) 282

Electronic Stability Program (ESP)

Deactivating 36

Function description 34-35

Electronic Stability Program (ESP) (option)

System description 33

Emergency equipment 106-107

Engine

Starting 19-21

Stopping 23

Event notifications 138-139

F

Fire extinguishing system

Red warning level 82-83

Folding out and folding in headlamps or bumper corner pieces 289-290

H

Heating, ventilation and air-conditioning system

Additional driver's area ventilation (option) 203

Driver's area - adjusting the blower speed 201

Driver's area - adjusting the temperature 200

Driver's area - cooling 202

Driver's area - setting the air distribution/demisting the windscreen 199

Driver's area control panel 97, 196-197

Fans on/off 215

Passenger compartment – switching automatic temperature regulation on and off 205

Passenger compartment – switching automatic temperature regulation on and off - code HH2/HK1 204

Passenger-compartment control panel 198

Passenger-compartment temperature - changing the base value 209-211

Switching air-recirculation mode on and off 203

Switching the auxiliary heating on and off 206-207

Switching the fans on/off (bus with air-conditioning system) 216-217

Switching the reheat function on and off 208

HOME button 149

I

Identification plate 1-2

Ignition starter switch .. 89, 97, 118

Instrument cluster 98-101

Instrument cluster “button assignment”

Buttons 146

Instrument cluster display screen

Operating, function and malfunction displays 140-145

J

Jacking points

Centre (articulated buses only) . 272

Front 272

General information 270-271

Rear 273

Jump-starting

Buses equipped with a battery charging socket 286

Where vehicle batteries are mounted side by side 284-285

M

Main menus 129-135

Display screen 128

Master safety switch (emergency-off switch) .. 98, 119-120

Menu

Button 150

Mirror and window heating

Activating/deactivating 176-177

N

Note symbols 5

O

Opening the emergency exit in the roof 287-288

Opening the hinged window 75

Operating pressure 30

Operating/malfunction displays

ABS/ASR 38

Brake system 31-32

Fuel system/exhaust gas cleaning system 60-61

P

Parking brake

Applying 167

General information 118

Releasing 168

Passenger stop request	66
Permanent displays	126
Pull-away aid	
Activating/deactivating	166
Pushchair stop request ...	250-252

R

Raising/lowering system

Lowering/raising the bus on the boarding side	162-163
Raising the bus above normal level	164-165

Ramp

Folding in/out	69-70
----------------------	-------

Ramp request**Refuelling**

AdBlue®	52-53
Diesel fuel	41-42
Opening/closing the fuel filler cap	47-48

RESET

Button	148
--------------	-----

Retarder

Direct	40
--------------	----

Disabling activation by brake pedal (option)	39
Roof hatches	212-214
Rotary light switch	91, 112
Running-in guideline	19

S

Screen

Malfunction displays: Yellow warning level	81
---	----

Seat belt

Driver's seat	184
---------------------	-----

SET

Button	151
--------------	-----

Setting the language**Snow chains****Steering column switch**

For light and wiper functions	89
Light and signal functions	113
Wiper and wash functions	113

Steering wheel buttons ...

Left	89, 160
Right	89, 158-159

Submenus

Display screen	128
----------------------	-----

T

Tachograph

Display	105
DTCO	89, 104
MTCO	89, 102-103

Towing**Towing****Towing coupling**

Front	26
Rear	27

Transmission cover

Tilting the seat row on the transmission cover	78, 187
---	---------

Trip meter

Resetting	147
-----------------	-----

Turn signal buzzer

Adjusting the volume	154
----------------------------	-----

Tyre pressure monitor**Tyres**

Cleaning the tyres	265
Flat tyre	270
Invisible tyre damage	264
Operating safety and roadworthi- ness	260
Retreaded tyres	265

Tyre age	263
Tyre condition	263
Tyre load capacity, top speed of tyres and types of tyres	264
Tyre pressure	261
Tyre pressures table	268-269
Tyre tread	263

Tyres/wheels

Retightening the wheel nuts	265
Wheel nut tightening torques	266

V

Vehicle data	292-293
---------------------	---------

Vehicle key

Overview	86-87
----------	-------

W

Winter operation	45
-------------------------	----