

07.2010 EvoBus GmbH

Not to be reprinted, reproduced or translated in any form without prior permission.

Address for orders:

EvoBus GmbH
Service Documentation
D-89077 Ulm, Germany

Printed in Germany

Order no.: A 628 584 69 82

Introduction

The user information supplied with each bus is only intended for use by those persons who are qualified to operate the bus. The user information is split into the following parts:

- The Driver's Operating Instructions are intended to answer all important questions concerning operation of the bus in a concise and clearly understandable manner.
- More detailed and complete information, as well as further information relevant to safety, can be found in the Operating Instructions.
- The Maintenance Record serves as a guide to the technical care of the bus. It contains all the information on maintenance intervals and maintenance tasks as well as pages for confirming that the maintenance work has been carried out.

Please make sure that you read the "Safety" section before you use the vehicle for the first time. Before the bus is driven, please make sure that you have read and understood the contents of these Operating Instructions.

Items of optional equipment are also described, if their operation needs explanation. The bus delivered to you has been customised in accordance with your order, therefore some descriptions and diagrams may differ from the equipment on your bus.

The Driver's Operating Instructions, the Operating Instructions and Maintenance Record are important documents and must always be carried in the bus.

Our buses are the subject of ongoing development. You are therefore asked to appreciate that we reserve the right to make modifications to the design, equipment and technical features. For these reasons, no claims can be made based upon the contents of this user information.

Environmental protection:

The declared policy of EvoBus GmbH is one of integrated environmental protection. This policy starts at the root causes and encompasses in its management decisions all the consequences for the environment which could arise from production processes or the products themselves.

The objectives are for the natural resources which form the basis of our existence on this planet to be used sparingly and in a manner which takes the requirements of both nature and humanity into account.

You can also help the environment by operating the bus in an environmentally-friendly manner. Fuel consumption and wear in the drive train (engine, clutch, transmission, axles, brakes, tyres) are extremely dependent on your driving style.

We hope you enjoy driving your bus.

EvoBus GmbH

Mercedes-Benz Omnibusse

Vehicle identification	1	Towing with a tow bar (articulated buses)	24	Winter operation with diesel fuels for buses with fuel-lubricated injection systems	41
Safety	5	Towing with the front axle raised (rigid and articulated buses)	26	Low-temperature characteristics of diesel fuels	42
General safety information	6	Front towing coupling	26	Diesel fuels available by region	42
Operation of auxiliary heating	10	Rear towing coupling (option)	28	Replacing the fuel filter	42
General	11	Brake system safety precautions	29	Addition of petrol	43
Preparation for the journey - daily tasks	12	Braking and stopping	29	Addition of flow improvers	43
Preparation for the journey - weekly tasks	13	Brakes with anti-locking protection	29	Measures required in the event of inadequate low-temperature characteristics	43
General bus care and maintenance	14	Brake pressure/supply pressure (operating pressure)	30	Measures required in the event of pre-existing paraffin separation	44
Care and cleaning	14	Brake system operating/malfunction displays	31	Winter operation with FAME biodiesel	44
Operation	15	Activating/deactivating acceleration skid control (ASR) (option)	33	Opening/closing the fuel filler cap	45
Running-in guideline	19	Operating/malfunction displays ABS/ASR	34	BlueTec exhaust gas cleaning system	47
Starting the engine	19	Disabling retarder activation by brake pedal (option)	35	Filling with AdBlue	49
Driving	21	Retarder direct (customer option)	36	Operating/malfunction displays: fuel system	50
Stopping the engine	23	Refuelling (diesel fuel)	37	Function of the accident data recorder (ADR) (option)	52
Towing with a tow bar (rigid buses)	23	Service products	39	Anti-jackknifing protection during forward travel	54
		AdBlue service product	40		

Malfunction displays: warning level C - overview	136	Activating/deactivating the bus stop brake	155	Transmission shift systems	169
Calling up/selecting/permanently displaying operating displays	137	Drive-off lock	156	Automatic transmission - general	170
Selecting the language on the screen	138	Important notes on the steering system	157	Selector positions of the 3-pushbutton switch panel	171
Calling up and interpreting the fuel consumption indicator (option)	140	Adjusting the steering wheel	158	Selector positions of the 6-pushbutton switch panel	173
Vehicle manoeuvrability when the air suspension is depressurised	142	Turning the steering wheel when the bus is stationary	159		
Lowering/raising the bus on the entry side	143	Opening/closing the driver's window	159	Heating/ventilation/air-conditioning	177
Raising the bus above normal level	145	Switching the mirror and window heating on and off	160	Safety instructions for the air-conditioning system	179
Activating/deactivating the pull-away aid	147	Switching the windscreen heating (option) on/off	161	Operating instructions for the air-conditioning system	179
Manual centring of the trailing axle	148			Heating/ventilation/air-conditioning control panel - driver's area	180
Activating/deactivating the automatic steering limiter for the trailing axle (bus stop function)	149	Driver's seat/passenger seats	163	Heating/ventilation/air-conditioning control panel - whole bus	182
Guide wheel loss detection	151	Important notes on the driver's seat	164	Driver's area - setting the air distribution/demisting the windscreen	183
Applying the parking brake	152	Grammer MSG 90.5 driver's seat control elements	166	Driver's area - adjusting the temperature	184
Releasing the parking brake	153	Using the driver's seat belt	168	Driver's area - adjusting the blower speed	185
Emergency braking in the event of failure of both brake circuits	154				

Table of contents

Driver's area - cooling	186		
Additional driver's area ventilation (option)	187		
Switching air-recirculation mode on and off	187		
Passenger compartment - switching automatic temperature regulation on and off - code HH2/HK1	188		
Passenger compartment - switching automatic temperature regulation on and off	189		
Switching the auxiliary heating on and off	190		
Switching the reheat function on and off	192		
Passenger-compartment temperature - changing the base value	193		
Opening the roof hatches	196		
Fans on/off	199		
Switching fans on and off - code HH2/HK1	200		
Auxiliary heating digital timer (option)	202		
Auxiliary heating operation (option)	203		
		Opening/locking	207
		Protection against entrapment in the door opening direction	209
		Protection against entrapment in the door closing direction	209
		Emergency operation - doors	210
		Forced door closure in an emergency	212
		Opening/closing door 1 from the outside	214
		Locking/unlocking the door leaves from the outside	214
		Opening/closing door 1 from the outside	215
		Opening/closing door 1 from the outside	216
		Locking door 1 with the key (option)	216
		Locking/unlocking the door leaves from the inside	217
		Opening/closing the doors from the inside	218
		Opening/closing automatic doors from the inside	219
		Opening/closing automatic doors from the outside	221
		Opening/closing automatic doors	223
		Switching between automatic and manual door operation	225
		Teaching in the doors in the closing and opening directions	227
		Pushchair stop request	231
		Practical advice	233
		Safety instructions for working in the engine compartment	236
		Engine oil level: oil level information on the screen	236
		Operating safety and roadworthiness	239
		Tyre pressure	239
		Tyre tread	240
		Tyre condition	240
		Tyre age	240
		Invisible tyre damage	241
		Tyre load capacity, top speed of tyres and types of tyres	241
		Retreaded tyres	242
		Cleaning the tyres	242
		Retightening the wheel nuts	242

Wheel nut tightening torques	243	Measures required for the prevention of damage to buses or components during electric welding work	258
Snow chains	243	Switching the on-board power supply on/off	259
Tyre pressures table	246	Switching off the on-board power supply at the master safety switch	260
Safety measures to be taken in the event of a flat tyre or a wheel change	248	Jump-starting where vehicle batteries are mounted one above the other	261
Jacking points	248	Jump-starting where vehicle batteries are mounted side by side	264
Jacking points, front	250	Jump-starting buses equipped with a battery charging socket	266
Jacking points, centre (articulated buses only)	250	Opening the emergency exit in the roof	268
Jacking points, rear	251	Folding out and folding in headlamps or bumper corner pieces . . .	269
Emergency release of the drive-off lock	252	Note on maintenance work	271
Parking brake emergency release (option)	253	Cleaning the underbody	271
Electrical system safety precautions	254		
General safety precautions for batteries	255	Technical data	277
Safety precautions for handling batteries	255	Vehicle data	278
Battery maintenance	256		
Recharging the batteries	256		
Working on the electrical system and electrical fuses	257		

Index	281
------------------------	------------



M00_01-0003-01

The vehicle identification plate with the vehicle identification number (VIN) and data concerning permissible weights is located on the forward structure near the front entrance.



Note:

It is very important to identify the vehicle exactly so that the correct "vehicle data" can be assigned. You will also need the VIN when ordering replacement parts and making technical enquiries.

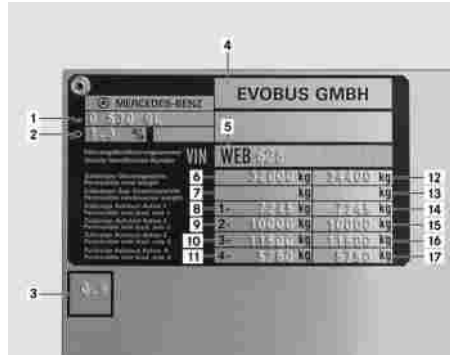

M00_01-0005-11

No.	Designation	Value
1	Vehicle model	
2	Headlamp basic setting	
3	Exhaust gas coefficient	
4	Vehicle manufacturer	EVOBUS GMBH
5	Vehicle Identification Number (VIN)	WEB 525

No.	Designation	Value
6	Permissible gross weight (country-specific)	
7	Permissible gross combination weight (country-specific)	
8	Permissible front axle load (country-specific)	
9	Permissible axle load for 2nd axle (country-specific)	
10	Permissible axle load for 3rd axle (country-specific)	
11	Permissible axle load for 4th axle (country-specific)	
12	Permissible technical gross weight	

No.	Designation	Value
13	Permissible technical gross combination weight	
14	Permissible technical axle load for front axle	
15	Permissible technical axle load for 2nd axle	
16	Permissible technical axle load for 3rd axle	
17	Permissible technical axle load for 4th axle	

Breakdown of the Vehicle Identification Number (VIN) with the example: WEB 628000 1 3 099427

WEB International manufacturer's code

WEB	EvoBus Germany/ France/Spain
-----	---------------------------------

628000 Vehicle model designation number

6280 -- Bus 12 metres, 2 axles

6281 -- Long version 15 metres, 3 axles

6282 -- Articulated bus 18 metres, 3 axles

628487 Bus 13 metres, 2 axles

628486 CapaCity articulated bus 20 metres, 4 axles

6285 -- Citaro LE

628000 Vehicle model designation number

6289 -- Citaro DH (DieselHybrid)

1 Steering

1 Left-hand drive

2 Right-hand drive

3 Production location and type of construction

1 MB chassis (Mannheim or Sámáno)

3 Complete bus (Mannheim, Istanbul, Neu-Ulm)

0 Alternative production location: Ligny en Barrois

A Alternative production location: Sámáno

099427

Serial end number

Six-digit serial number

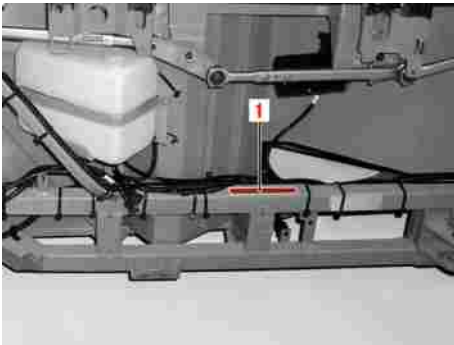

M00_00-0491-71

Vehicle identification number (1) is additionally marked on the skeleton at the front of the bus. It is accessible via the front flap.

General safety information	6
Operation of auxiliary heating	10

General safety information

General safety information

The use of symbols and their meanings

Safety instructions and other important instructions are highlighted by symbols.

In addition to the instructions listed in the contents, the safety and accident prevention regulations issued by German Employer's Liability Insurance Associations must be observed.

Additionally, instructions printed on packaging for components, tools and service products must be followed.

It is also generally assumed in the undertaking of these instructions that the user information is intended for persons who are qualified to carry out the tasks by nature of their education, training and experience.

At the same time, these persons should be able to identify risks that may arise in the undertaking of their tasks and to take the necessary measures to avoid them.

Meaning of symbols:



Note:

Notes about important additional information



Caution:

Warning notes about damage that may occur in the event of non-compliance



Danger.

Warning notes for risks to persons



Environmental protection

Notes about environmental protection measures

▷ Reference to more detailed and additional user information

Notes on vehicle safety

We recommend that you:

- Only use genuine parts that are OM-NIplus quality tested and conversion parts and accessories that have been expressly approved by EvoBus for the bus model concerned to rule out the possibility of jeopardising the warranty, driving safety and the validity of the operating permit. These parts have been specially tested for their safety, reliability and suitability.

You can obtain further information from any EvoBus Service Partner.

Operating safety

Important notes:

- Any work or modifications that have been carried out incorrectly on the bus may result in malfunctions.
- Tampering with electronic components and their software may cause malfunctions. As electronic components are networked, these malfunctions may also result in faults in sys-

General safety information

- tems that are not directly affected. These malfunctions may considerably jeopardise the operating safety of the bus.
- Retrofitted electrical or electronic devices must possess type-approval complying with Directive 95/54/EC or ECE Directive 10/02.
- Materials that are fitted in the bus during the course of installation, conversion or modification and which fall within the conditions for components required to be fire-tested must also satisfy the conditions of EU Directive 95/28/EC.
- Materials and components in seats and seat fixtures that are also fitted in the bus during the course of installation, conversion or modification must also satisfy the following directives: 76/115/EEC as amended by 96/38/EC, 74/408/EEC as amended by 96/37/EC, 77/541/EEC as amended by 96/36/EC,
- When such materials and components are purchased or installed, care shall be taken to ensure that they are appropriately certified. Use of materials and components that do not possess the certificate referred to above can result in the operating permit being invalidated.
- We recommend that you have any work or modifications carried out by an EvoBus Service Partner.

Stickers

There are various warning stickers affixed to your bus. These are intended to make you and others aware of various dangers. Therefore, do not remove any warning stickers unless it is expressly stated on the sticker that you may do so.



Danger.

If you remove warning stickers, this could result in you or other persons failing to recognise dangers. You or others could be injured as a result.

Navigation and location system

Please follow the instructions below if your bus is fitted with a navigation system:



Danger.

Please devote your attention primarily to road and traffic conditions. Only operate the navigation and location system when the bus is stationary. Please remember that your bus covers 14 m every second when it is only travelling at approximately 30 mph (50 km/h). The navigation system is unable to detect the maximum load-bearing capacity for bridges or the maximum permissible height for driving through underpasses. The driver is responsible for ensuring that bridge load-bearing capacities and maximum headroom clearance are not exceeded.

General safety information

Operation of the radio and mobile communications equipment

(e.g. telephone, radio, fax machine, etc.)



Danger.

Please devote your attention primarily to road and traffic conditions. Only operate the display unit, radio or mobile communications equipment if the traffic situation permits this. Please remember that your bus covers 14 m every second when it is only travelling at approximately 30 mph (50 km/h).



Note:

According to Section 23, Paragraph 1a of the German road traffic regulations (StVO), the bus driver is not permitted to use a mobile phone or permanently-installed phone in the Federal Republic of Germany if it is necessary to lift up or hold the mobile phone or the handset of the permanently-installed phone.



Danger.

Please observe the legal requirements for the operation of mobile phones or vehicle phones in each country.

Operation of mobile phones and radio equipment without an exterior aerial

We advise against making telephone calls in the bus without an exterior aerial as the operation of radio transmission equipment including radio telephones (mobile phones) may result in the malfunction of inadequately shielded medical equipment (cardiac pacemakers).



Note:

If a mobile phone, radio or fax machine is retrofitted on the bus in a way that does not comply with the EvoBus installation instructions, the operating permit for your bus may be invalidated (EU Directive 95/54/EC).



Note:

Installed furnished parts (e.g. ticket-printing machine, ticket-validating machine, destination display, etc.) that are still in use in new buses must comply with the technical requirements of EU Directive 72/245 EEC.



Danger.

Please observe the legal requirements for the operation of mobile phones or vehicle phones in each country.

Washing the outside of the bus in an automatic vehicle wash

Prior to washing the bus you must check that the roof hatches, driver's window and the doors are closed. Set the heating/ventilation/air-conditioning control to air-recirculation mode (smog button).

General safety information



M88_00-0085-71

Before you wash the bus you must fold right-hand exterior mirror (1) inwards towards the windscreen at the hinge on the mirror arm.

After the washing process, fold the exterior mirror outwards again.

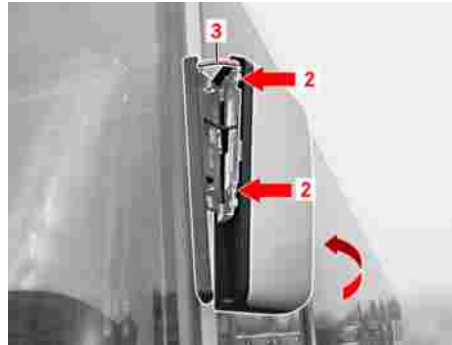

M88_00-0081-71

Disengage the left-hand mirror from two retaining springs (2) by yanking the outside edge of the mirror housing to the rear. The mirror can now be pivoted up to a distance of 90 mm from the outside surface of the bus. In this position, a tensioning spring (3) prevents the mirror from swinging back inadvertently.

After the washing process, bend tensioning spring (3) slightly by pressing from the side, pivot the mirror towards the front of the bus and engage it in the retaining springs.

Remove attachment parts (e.g. roof-mounted satellite receivers, exterior aerials, etc.) before the washing process.

Operation of auxiliary heating

Operation of auxiliary heating



Danger.

Risk of fire and burns. There is a risk of fires and burns due to the high exhaust temperatures and the hot exhaust pipe for the auxiliary heating. For this reason, do not stop or park the bus over ignitable materials (e.g. grass) when the auxiliary heating is in operation, has recently been in operation or has been operated by the immediate heating button/preset clock.



Danger.

Risk of poisoning and suffocation. The auxiliary heating must not be used in enclosed spaces such as garages or workshops due to the risk of poisoning and suffocation. It must also not be used in timer or preselection mode.



Danger.

Risk of explosion. The auxiliary heating must be switched off at filling stations and fuel dispensing systems due to the risk of explosion.



Danger.

Risk of fire. The auxiliary heating must remain switched off in places where ignitable vapours or dust can accumulate (e.g. in the vicinity of filling stations, fuel, coal, sawdust and grain stores or similar).



Caution:

The heating unit must be operated for 10 minutes at least once a month (also during the warm season) when the engine is cold.

Preparation for the journey - daily tasks 12

Preparation for the journey - weekly tasks 13

General bus care and maintenance 14

Care and cleaning 14

Preparation for the journey - daily tasks

Preparation for the journey - daily tasks

- ▶ Check the windscreen washer fluid level and test the windscreen washer system and windscreen wipers.
- ▶ Check the fuel level for the engine and auxiliary heating



Danger.

Switch off the engine and auxiliary heating before refuelling.

- ▶ Check the AdBlue additive level in the BlueTec exhaust gas cleaning system
- ▶ Check the electrical system, paying particular attention to the headlamps, turn signals, tail lamps, brake lamps and licence plate lamps.



Note:

Under certain weather and operating conditions, moisture may form on the inside of the headlamps and other lights when the bus is stationary. This does not indicate a fault or defect. The ventilation openings in the headlamps allow this moisture to evaporate after the bus has been driven for a short time.

- ▶ Check the service covers for secure locking
- ▶ Check the emergency exits
- ▶ Insert the tachograph recording disc or the driver card.



Note:

If the indicator lamp in the tachograph is lit, no disc or driver card has been inserted.

- ▶ Check that the emergency equipment is accessible and complete, e.g. first-aid kit, fire extinguisher, warning triangle, emergency hammer for side windows, jack.

- ▶ Check the adjustment of the interior and exterior rear-view mirrors, clean the mirrors, check the mirror heating for correct function.
- ▶ Check tyre pressures and tyre condition. Check that the wheel nuts are firmly seated.

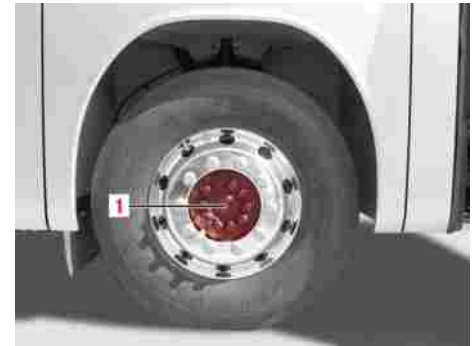

M40_00-0115-71

- ▶ Check wheel hubs (1) on all wheels for leaks inside and out (visual check).

Preparation for the journey - weekly tasks

**Note:**

If the wheel hubs are leaking, there may be grease or oil residue on the tyres themselves or deposits on the parking area on which the bus is standing. Consult an EvoBus Service Partner in the event of a leak.

Preparation for the journey - weekly tasks

- ▶ Check the oil level in the hydraulic steering system.

**Caution:**

If the oil level is low, have the steering system checked at an authorised specialist workshop.

- ▶ Check the belt tension of all belt drives.
- ▶ Carry out a visual check to ensure there are no leaks in the engine, transmission, driven axle, steering or the cooling and heating systems.
- ▶ Drain the fuel prefilter in the engine compartment.

- ▶ Check the acid level in the starter batteries.

**Danger.**

Observe the safety precautions in the “Practical advice” section.

General bus care and maintenance

General bus care and maintenance

- ▶ Carry out the work specified in the Maintenance Record



Danger.

Risk of accident. Maintenance tasks must be carried out on the chassis and drive train at regular intervals to maintain the operating safety and roadworthiness of the bus. The time intervals and the scope of the required tasks are specified in the Maintenance Record.



Caution:

It is strongly recommended that the specified maintenance intervals be observed.



Note:

Warranty claims may be rejected if the periodic maintenance tasks have not been carried out at the specified distances (odometer reading) or times. Have confirmation of the completion of the work specified in the Maintenance Record recorded by an EvoBus Service Partner.

Care and cleaning

- ▷ You will find instructions and notes on caring for and cleaning your bus in the “Operation” section.

Running-in guideline 19

Starting the engine 19

Driving 21

Stopping the engine 23

Towing with a tow bar (rigid buses) 23

Towing with a tow bar (articulated buses) 24

Towing with the front axle raised (rigid and articulated buses) 26

Front towing coupling 26

Rear towing coupling (option) 28

Brake system safety precautions 29

Braking and stopping 29

Brakes with anti-locking protection 29

Brake pressure/supply pressure (operating pressure) 30

Brake system operating/malfunction displays 31

Activating/deactivating acceleration skid control (ASR) (option) 33

Operating/malfunction displays ABS/ASR 34

Table of contents

Disabling retarder activation by brake pedal (option)	35
Retarder direct (customer option)	36
Refuelling (diesel fuel)	37
Service products	39
AdBlue service product	40
Winter operation with diesel fuels for buses with fuel-lubricated injection systems	41
Low-temperature characteristics of diesel fuels	42
Diesel fuels available by region	42
Replacing the fuel filter	42
Addition of petrol	43
Addition of flow improvers	43
Measures required in the event of inadequate low-temperature characteristics	43
Measures required in the event of pre-existing paraffin separation	44
Winter operation with FAME biodiesel	44
Opening/closing the fuel filler cap	45
BlueTec exhaust gas cleaning system	47

Filling with AdBlue	49
Operating/malfunction displays: fuel system	50
Function of the accident data recorder (ADR) (option)	52
Anti-jackknifing protection during forward travel	54
Anti-jackknifing protection during reverse travel	54
Stop request	55
Ramp request	56
Safety precautions for the operation of folding/cassette ramps, various lift models (options)	57
Folding the ramp in/out	58
Pulling out/sliding in the platform	60
Retracting/extending the electric cassette ramp	63
Opening the hinged window	66
Care and cleaning	66
Tilting the rear seats	67
Skibox (option)	68
Care and cleaning of covers and upholstery	70

Table of contents

Care/cleaning of fabric covers	70
Malfunction display: yellow warning level A	71
Malfunction display: red warning level	72

Running-in guideline

▶ Running in the chassis and drive train

**Note:**

The way in which the chassis and drive train of the new bus are treated during the first 3,000 miles (5,000 km) is critical to the future performance and service life of the bus.

**Note:**

During the first 3,000 miles (5,000 km), the load to which the bus is subjected should be increased only gradually. The maintenance and lubrication tasks specified in the Maintenance Record should be carried out conscientiously.

**Caution:**

Do not place the engine under full load during the first 3,000 miles (5,000 km).
Up to 1,200 miles (2,000 km): run in with care. Do not drive at any more than 3/4 of the maximum engine speed for each gear. After 1,200 miles (2,000 km):

slowly increase to the economic rpm in each gear. During the first 3,000 miles (5,000 km), do not drive the bus for long distances at a constant road speed or engine speed. Varying engine speeds and therefore varying loads demanded of the drive train are favourable to the running-in of the bus.

Starting the engine**Note:**

Precondition: parking brake applied, transmission in neutral position, electrical system on.

**Note:**

At outside temperatures of below -20 °C, preheat the engine using the auxiliary heating (see heating/ventilation/air-conditioning control panel).

Starting the engine

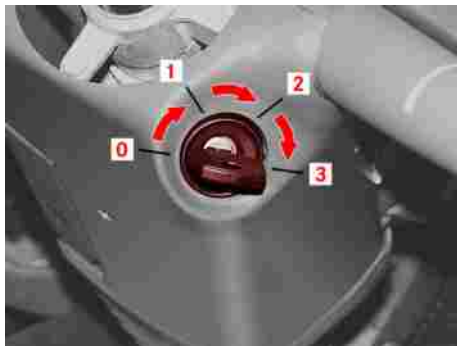

M54_00-0083-01

- ▶ Turn the key to drive position (2).

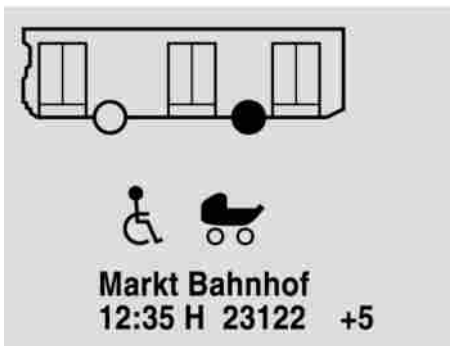

M54_00-0174-01

Operating displays are displayed one after the other during initialisation of electrical systems.



Note:

Before you start the engine, wait until the electrical systems have been initialised and the “Bus stop” indication display appears on the screen.



Note:

If the bus is equipped with a cold-start aid, this will be activated if the outside temperature or coolant temperature is below a specific value. This symbol  appears on the display screen on activation of the preglow function. It is possible to start the engine as soon as the symbol goes out. The symbol goes out immediately if the engine is started before the preglow period has elapsed.

The engine can be started.

- ▶ Turn the key to starting position (3). Do not depress the accelerator pedal. Release the key as soon as the engine starts.



Note:

Depress the accelerator pedal slowly if the engine does not start after approximately 5 seconds. If necessary, interrupt the starting procedure after a maximum of 15 seconds, wait approximately 1 minute, and try again. Turn the key

back to its initial position (0) before the next starting attempt. Introduce a pause (approximately 15 minutes) after three starting attempts. Release the key after the engine has started, release the accelerator pedal. Observe the indicator lamps immediately after the engine has started. If no malfunction is indicated, it is possible to pull away.

**Danger.**

Never lock the steering while the bus is in motion. Whenever you disembark, even for a short time, always remove the key so that the bus cannot be started by children or other unauthorised persons.

**Caution:**

It is prohibited to increase the engine speed while the “Oil pressure too low” symbol is shown on the display screen. If the “Oil pressure too low” symbol appears for more than 10 seconds, turn off the engine immediately and establish the cause.

**Environmental protection**

Never leave the engine to warm up with the bus stationary. Instead, drive off and operate the engine at moderate engine speeds.

**Note:**

The engine should not be placed under full load until it has reached normal operating temperature (75 °C to 90 °C depending on operating conditions and the outside temperature).

Driving**Environmental protection**

Never leave the engine to warm up with the bus stationary. Instead, drive off and operate the engine at moderate engine speeds.

**Note:**

The engine should not be placed under full load until it has reached normal operating temperature (75 °C to 90 °C depending on operating conditions and the outside temperature).

**Danger.**

All doors must be unlocked before the bus is driven off.

Driving



Danger.

The freedom of movement of the pedals must not be restricted. The operating safety and roadworthiness of the bus would otherwise be at risk. Objects could fall and get caught between the pedals if you were to accelerate or brake suddenly, with the result that you would no longer be able to brake, depress the clutch pedal or accelerate. You could cause an accident and endanger yourself and others.

- ▶ Check the freedom of movement of the pedals



Danger.

Where floor mats and carpets are fitted, make sure that these are safely secured against slipping and that the pedals have sufficient clearance.



Danger.

Do not stow any objects in the driver's footwell.



Danger.

Stow and secure all loose objects in such a way that they cannot get into the driver's footwell when the bus is in motion.

- ▶ Keep an eye on the rev counter while driving.



Note:

Keep within the economical operating range. Make sure that the engine speed does not enter the danger zone (red zone).



Danger.

Test the service brake immediately after pulling away.

Stopping the engine

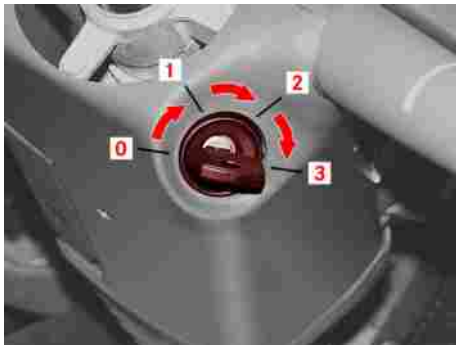

M54_00-0083-01

- ▶ Stop the bus, shift transmission to neutral, apply parking brake. Turn the ignition starter switch from position 2 (drive position) back to position 1.



Danger.

There is a risk of fire and burns due to the high exhaust temperatures and the hot exhaust pipe for the auxiliary heating. For this reason, make sure when stopping the bus that there is no ignitable material (e.g. dry grass, leaves, etc.) in the area around the exhaust system, the engine and the auxiliary heating exhaust system.



Note:

Before you switch off the engine, allow it to continue running at idling speed for approximately 1-2 minutes (to allow the exhaust turbochargers to cool down if the coolant temperature is high or if you have been driving at full engine output (e.g. on hilly roads)).

Towing with a tow bar (rigid buses)



Danger.

Only authorised specialists (recovery service) are permitted to tow away broken-down buses. The rules and regulations in the country concerned must be observed.



Caution:

Special measures are required in order to protect the transmission if the bus is to be towed: In the interests of safety, the propeller shaft must always be removed. The propeller shaft securing screws at the axle flange must be removed and those at the transmission flange secured against displacement.

Towing with a tow bar (articulated buses)



Danger.

The ignition starter switch of the vehicle being towed must always remain in position 2 during the towing procedure. The steering lock must not be allowed to engage. Failure to comply with this guideline could result in the steering locking. Safety-relevant functions would no longer be operational.



Note:

The front flap must remain closed for the duration of the towing procedure.



Note:

The towing coupling is suitable only for towing vehicles having a gross weight of no more than 18 tonnes.



Note:

The towing coupling must not be used for towing trailers.

Towing with a tow bar (articulated buses)



Danger.

Only authorised specialists (recovery service) are permitted to tow away broken-down buses. The rules and regulations in the country concerned must be observed.



Caution:

Special measures are required in order to protect the transmission if the bus is to be towed: for safety reasons the propeller shaft must always be removed. The propeller shaft securing screws at the axle flange must be removed and those at the transmission flange secured against displacement.

Towing with a tow bar (articulated buses)

**Danger.**

The ignition starter switch of the vehicle being towed must always remain in position 2 during the towing procedure. The steering lock must not be allowed to engage. Failure to comply with this guideline could result in the steering locking. Safety-relevant functions would no longer be operational.

**Note:**

The front flap must remain closed for the duration of the towing procedure.

**Note:**

The towing coupling is suitable only for towing vehicles having a gross weight of no more than 18 tonnes.

**Note:**

The towing coupling must not be used for towing trailers.

- ▶ Disconnect connector V 15-pin from the articulation angle control unit in the roof cross duct (22A01).

**Caution:**

Before you disconnect the power supply from the articulation angle control unit, switch the ignition starter switch to position 0.

**Note:**

For control unit locations, see legend in the roof cross duct.

**Note:**

Gear selection switch: press the “N” pushbutton.

The red warning lamp lights up because power is no longer being supplied to the articulation angle control unit.

**Note:**

In this condition, the articulation angle control unit cannot activate the bus stop brake automatically.

**Caution:**

Articulation protection is in emergency damping mode. Articulation protection and vehicle stabilisation functions are extremely limited. Vehicle handling characteristics will differ during the towing procedure. A suitable driving style must therefore be adopted.

Towing with the front axle raised (rigid and articulated buses)

Towing with the front axle raised (rigid and articulated buses)



Danger.

Only authorised specialists (recovery service) are permitted to tow away broken-down buses. The rules and regulations in the country concerned must be observed.



Caution:

Special measures are required in order to protect the transmission if the bus is to be towed: In the interests of safety, the propeller shaft must always be removed. The propeller shaft securing screws at the axle flange must be removed and those at the transmission flange secured against displacement



Danger.

The ignition starter switch must not be switched to position 1 or 2 while the front axle is raised. The wheels on the driven axle may lock. Failure to comply could result in brake intervention by

ABS/ASR, which could cause the rear axle to skid. Articulated buses: above a speed of 12 km/h, this could happen even sooner, whether during straight-ahead travel or with the articulation at an angle. In addition, the bus stop brake would be activated by the articulation angle control unit.



Caution:

Articulated buses: with the ignition starter switch in position 0, articulation protection is in emergency damping mode. Articulation protection and vehicle stabilisation functions are extremely limited in this mode.

Front towing coupling

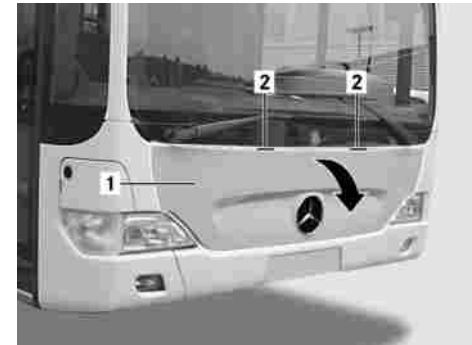

M88_00-0082-01

- ▶ Grasp handle recesses (2) with both hands and open front flap (1).

Front towing coupling

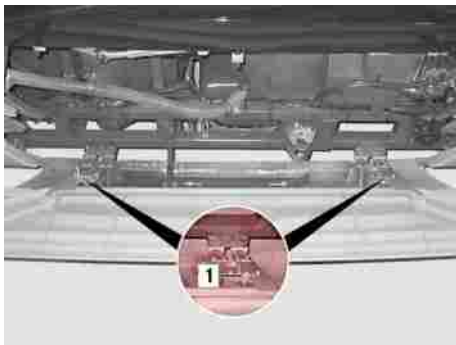

M00_00-0338-71

- ▶ Move the levers on both flap locks (1) to the left (when viewed in the direction of travel) to release the lower section of the front flap.

The lower section of the front flap folds down.

i **Note:**

A retention strap prevents the lower section of the front flap from folding down completely.

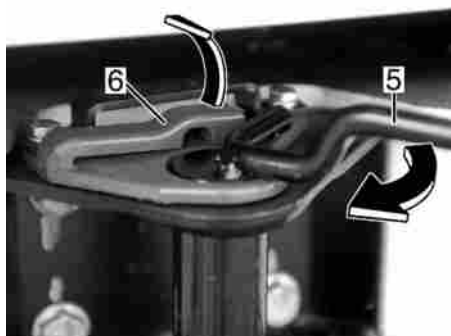

M88_00-0060-01

- ▶ Lift locking tab (6) slightly and turn the linchpin clockwise by handle (5) until it is released.
- ▶ Pull the linchpin up and out of the towing coupling.
- ▶ Fit the eyelet of the tow bar into the towing coupling.
- ▶ Fit the linchpin into the towing coupling and eyelet of the tow bar.

- ▶ Turn the linchpin anti-clockwise by handle (5) until locking tab (6) engages.

i **Note:**

The linchpin must remain engaged in locking tab (6) at all times.

- ▶ Close the front flap.

Rear towing coupling (option)

Rear towing coupling (option)

- ▶ Remove the linchpin from the front towing coupling.



Note:

The rear towing coupling is optional equipment and has no linchpin.

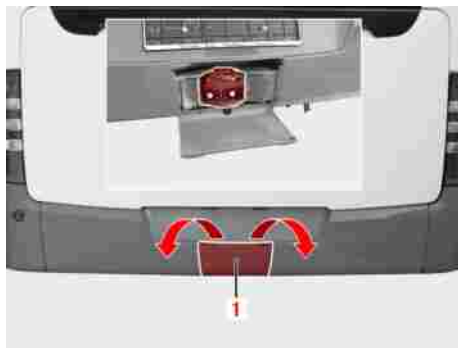

M00_00-0492-71

- ▶ Remove cover (1).
- ▶ Fit the eyelet of the tow bar into the towing coupling.

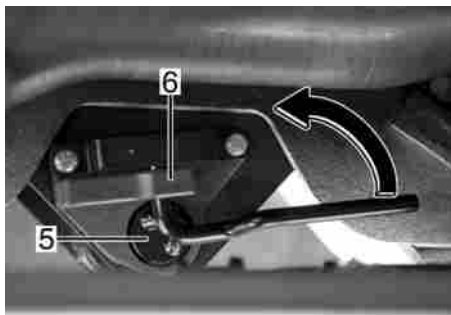

M88_00-0061-01

- ▶ Fit linchpin (5) into the towing coupling and eyelet of the tow bar.
- ▶ Turn linchpin (5) anti-clockwise by the handle until locking tab (6) engages.



Note:

Linchpin (5) must remain engaged in locking tab (6) at all times.

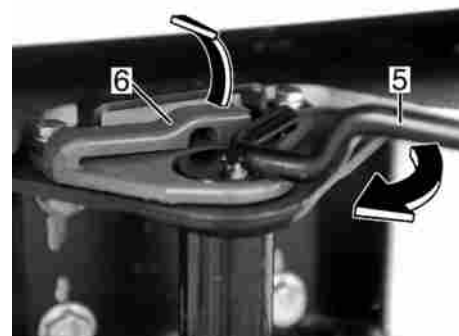

M88_00-0060-01

- ▶ At the end of towing, lift locking tab (6) slightly and turn the linchpin clockwise by handle (5) until it is released.
- ▶ Refit the linchpin into the front towing coupling and secure it.

Brake system safety precautions

Brake system safety precautions



Caution:

The braking characteristics of the bus may change if a yellow warning level malfunction in the brake system is displayed on the screen in the instrument cluster. Drive with extreme care. Have the fault rectified as soon as possible by an EvoBus Service Partner.



Danger.

The braking characteristics of the bus have changed if a red warning level malfunction in the brake system is displayed. Pedal travel may increase under braking. ABS is switched off. Stop the bus immediately and disable it (traffic conditions permitting). Have an EvoBus Service Partner rectify the fault immediately.

Braking and stopping

- ▶ Whenever the bus is driven over long downhill stretches, you should make use of the braking effect of the engine by shifting into a lower gear. To relieve the service brake of load, use the integrated retarder in accordance with the manufacturer's operating instructions.



Note:

Except for emergencies, the service brake does not usually need to be applied sharply.



Danger.

Always apply the parking brake before you disembark. On uphill and downhill gradients, you must also chock the wheels and turn the steering towards the kerb.

Brakes with anti-locking protection

- ▶ In a hazardous situation, the brake pedal should be depressed fully. This ensures that all wheels are braked with ABS assistance and optimum deceleration is achieved.



Note:

The retarder is deactivated automatically for the duration of an ABS control intervention.



Danger.

The anti-locking protection of ABS does not relieve the driver of the responsibility for adopting a driving style which takes traffic and road conditions into account. While the directional stability and steerability of the bus are improved under braking, ABS is not able to avert the consequences of, for example, driving at an unsafe distance behind a vehicle in front or driving too fast through bends.

Brake pressure/supply pressure (operating pressure)



Danger.

If the bus is towing a trailer that does not have ABS, this trailer could be overbraked if the brakes were applied with maximum force. In this case, the driver must keep an eye on the trailer in the rear-view mirror. The bus equipped with ABS remains steerable, thereby enabling the driver to keep it stable.

Brake pressure/supply pressure (operating pressure)



Note:

Precondition: minimum operating pressure of 5.5 bar, “Brake pressure/supply pressure” display selected.



Danger.

Risk of accident. A supply pressure of at least 6.8 bar in the individual compressed-air circuits is required to ensure the operating safety of the bus. A leaking compressed-air brake system jeopardises the operating safety and roadworthiness of the bus. Stop immediately (traffic conditions permitting) if the supply pressure in the brake system is too low. Have the brake system checked at an EvoBus Service Partner.

- ▶ Apply the service brake.



M54_00-1162-71

The following appears on the screen: “Brake pressure” (A) in brake circuits 1 and 2 with the service brake is applied.



Note:

The brake pressure is approximately 9 bar with the service brake fully applied.

- ▶ Release the service brake.

Brake system operating/malfunction displays

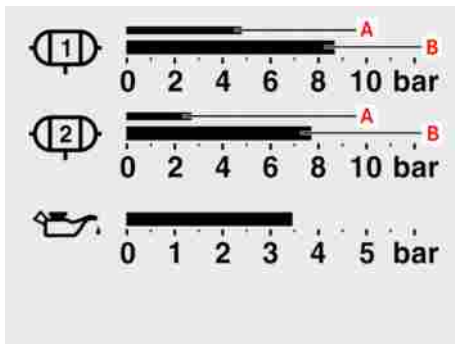

M54_00-1162-71

The following appears on the screen:
 “Supply pressure” (B) present in
 brake circuits 1 and 2.

i **Note:**

The maximum supply pressure (B) for
 brake circuits 1 and 2 is approximately
 10 bar.

i **Note:**

If the supply pressure falls below 6.8 bar,
 the “Brake pressure/supply pressure”
 display is automatically displayed on the
 screen and the warning lamp for the yellow
 warning level lights up.

Brake system operating/malfunction displays

“Parking brake applied” indication display (A)

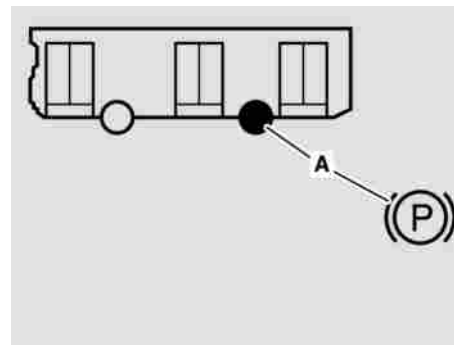

M54_00-0232-01

Brake system operating/malfunction displays

Bus stop brake/drive-off lock active

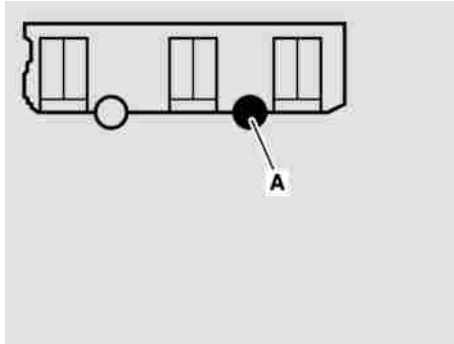

M54_00-0237-01

switch of the bus stop brake has been operated.

“Brake pressure” display

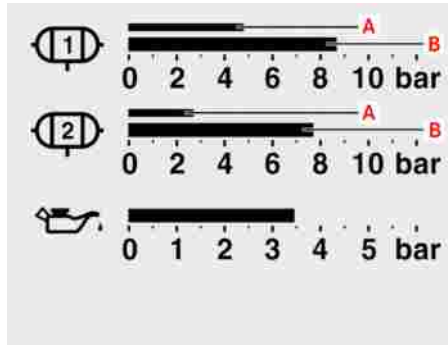

M54_00-1162-71

The following is shown on the screen: “Brake pressure” (A) in brake circuit 1 and 2 if the service brake is applied.

Reservoir pressure display

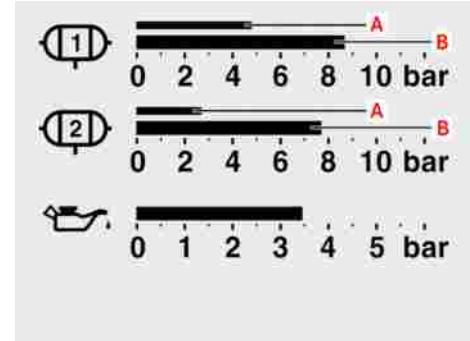

M54_00-1162-71

The following is shown on the screen: Available reservoir pressure (B) in brake circuits 1 and 2.

Bus stop brake/drive-off lock malfunction

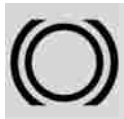

If this symbol is displayed in conjunction with the “Bus stop brake malfunction” message, either the bus stop brake is defective or the emergency release

Brake pad wear



If the brake pads/linings are too worn, this is indicated on the screen by a service message and a yellow warning level malfunction message.

Activating/deactivating acceleration skid control (ASR) (option)

**Danger.**

The braking characteristics of the bus may change if a yellow warning level malfunction in the brake system is displayed on the screen in the instrument cluster. Drive with extreme care. Have the fault rectified as soon as possible by an Evo-Bus Service Partner.

Activating/deactivating acceleration skid control (ASR) (option)

**Note:**

If traction problems arise when the bus is travelling with anti-skid chains or on routes with loose surfaces (e.g. sand and gravel): deactivate acceleration skid control.

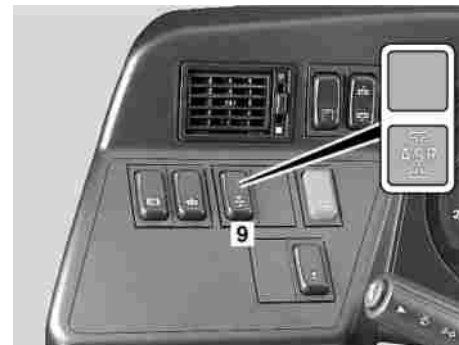

M54_00-0128-01

- ▶ Press pushbutton (9) with the ignition switch switched on in position 2.

**Danger.**

The bus may skid out of control if ASR is deactivated and the drive wheels start to spin.

- ▶ Pressing pushbutton (9) again or switching the ignition switch off and then back on again reactivates acceleration skid control.

Operating/malfunction displays ABS/ASR

Operating/malfunction displays ABS/ASR

ABS/ASR malfunction



In the event of an ABS/ASR failure or malfunction, a red or yellow warning level malfunction, depending on fault severity, is displayed.



Note:

If a yellow warning level malfunction is displayed after the ignition has been switched on, release the parking brake and depress the brake pedal fully for 2 seconds. If the fault alert continues to be displayed, pull away and continue to monitor the display. If the fault alert is still present even after you have pulled away, it is necessary to visit a workshop.



Danger.

The wheels could lock, especially on a slippery surface - risk of skidding.



Danger.

The braking characteristics of the bus may change if a yellow warning level malfunction in the brake system appears on the instrument cluster display screen. Adopt a particularly cautious driving style. Have the malfunction rectified as soon as possible by an EvoBus Service Partner.



Danger.

The braking characteristics of the bus have changed if a red warning level malfunction is displayed. Pedal travel may increase under braking. ABS has been disabled. Stop the bus immediately and disable it (traffic conditions permitting). Have the malfunction rectified by an EvoBus Service Partner immediately.

Acceleration skid control (ASR) active



ASR is activated automatically if the drive wheels on one or both sides start to spin. An active ASR intervention is indicated by this icon in the Driving operating display menu on the screen. If the drive wheels on one side start to spin, they will be braked automatically. - If the drive wheels on both sides start to spin, engine output will automatically be reduced.



Danger.

Risk of accident. Acceleration skid control does not relieve the driver of the responsibility for adopting a driving style which takes traffic and road conditions into account.

Disabling retarder activation by brake pedal (option)

Deactivating acceleration skid control (ASR)



Acceleration skid control can be deactivated using the “ASR OFF” pushbutton.

i Note:

This icon appears flashing on the instrument cluster display screen.

⚠ Danger.

Risk of accident. The bus could skid if ASR has been switched off and the drive wheels start to spin.

Disabling retarder activation by brake pedal (option)

i Note:

This switch is for use mainly in wintry road conditions so that the driver can moderate the braking effect more effectively.

i Note:

Disabling the retarder results in increased wear of the brake pads.

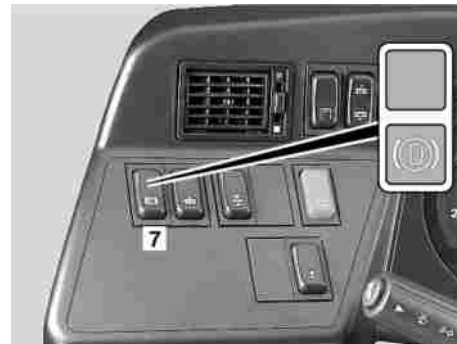

M54_00-0145-01

► Press the lower section of switch (7).

i Note:

The retarder is now decoupled from the service brake and is no longer operated when the brake pedal is depressed.

Retarder direct (customer option)

- ▶ Press the upper section of switch (7).



Note:

The retarder is coupled with the service brake again and is operated when the brake pedal is depressed.

- ▶ Depress the brake pedal.



The following appears on the screen:
“Retarder active”.

- ▶ Release the brake pedal.

The “Retarder active” indication display on the screen goes out.

Retarder direct (customer option)



Danger.

Risk of accident. The braking effect of the retarder is automatically reduced as a function of the operating temperature to protect the retarder from overheating during continuous operation. Adjust your driving style, particularly on long downhill gradients. Do not engage the retarder when the road surface is slippery as the wheels may block (risk of skidding).

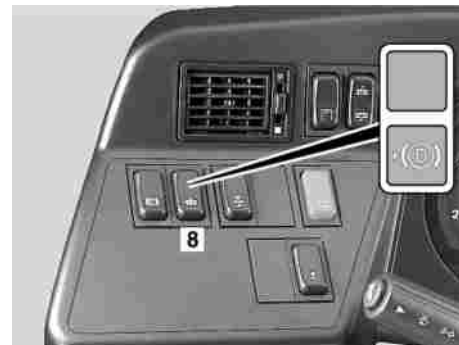

M54_00-0143-01

- ▶ Press the lower section of switch (8).

The retarder is operational.

- ▶ Fully release the accelerator pedal.

The bus is directly braked with the highest retarder stage.



The following is shown on the screen:
“Retarder active”.

Refuelling (diesel fuel)

Use only diesel fuels compliant with EN 590 (refer to Specifications for Service Products). Use winter-grade diesel fuel in the cold season (down to approximately -20 °C). If outside temperatures fall even further, the flow properties of the diesel fuel could deteriorate to an unusable level due to paraffin separation. As a preventive measure for this situation, it is permissible to add a specific amount of kerosene or an approved flow improver proportionate to the outside temperature. Engine output may be degraded in line with the amount of additive. The amount of additive should therefore be kept as low as possible under consideration of prevailing outside temperatures. (Maximum kerosene additive 50 %.) The addition of kerosene reduces the flash point of the diesel fuel. The dangers associated with working with this fuel mixture are therefore increased. Observe all relevant safety regulations. Switch off the engine and auxiliary heating before refuelling. Turn the ignition



Note:

When switch (8) is pressed down, it is necessary to release the accelerator pedal completely to permit braking with the retarder.

- ▶ Depress the accelerator pedal.

Braking of the bus using the highest retarder stage is interrupted.



Note:

If the accelerator pedal is operated, retarder braking is interrupted until the accelerator pedal is fully released again.



The “Retarder active” indication display on the screen goes out.

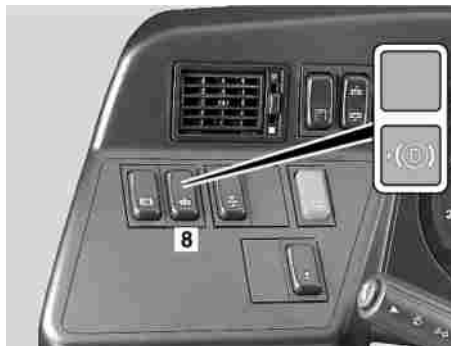

M54_00-0143-01

- ▶ Press the upper section of switch (8).
Braking of the bus using the highest retarder stage is switched off.

Refuelling (diesel fuel)

starter switch back to position 0. Park the bus on a level surface.

Cleanliness is of utmost importance when refuelling. Do not leave cotton rags or cloths in the vicinity of the open filler neck.

Close the fuel tank properly once filling is complete.



Danger.

Risk of injury and explosion. Fuel is highly flammable. Fire, naked flames and smoking are therefore prohibited when fuel is being handled.



Danger.

Switch off the auxiliary heating before refuelling to prevent fuel vapour from igniting on the auxiliary heating's exhaust system.



Danger.

Fuel is toxic and harmful to health. For this reason, make sure that the fuel does not come into contact with skin, eyes or clothing, that you do not inhale fuel vapours and that children are kept away from the fuel.



Danger.

If you or others have come into contact with fuel: in case of contact with the eyes, rinse them immediately and copiously with clean water and seek medical attention. Clean affected areas of skin immediately with soap and water. Immediately change out of clothing that has come into contact with fuel. If fuel has been swallowed, seek immediate medical attention.



Environmental protection

Unless they are handled properly, fuels constitute a risk both for people and for the environment. Fuels must not be allowed to enter the sewage system, surface water, ground water or soil.

Service products

Service products are: fuels, lubricants (e.g. engine oils, transmission oils, greases), coolants, brake fluids, etc.

Structural parts and service products must be matched to each other. For this reason, only brands that have been approved by EvoBus are permitted to be used. These are stipulated in the EvoBus Specifications for Service Products.



Danger.

Risk of injury. Service products are harmful to health. Contact a doctor immediately if someone has swallowed a service product. Avoid inhaling fumes where possible. Do not allow service products to come into contact with skin, eyes or clothing. Clean any affected areas with water and soap. Rinse eyes thoroughly with clean water in case of contact. Change out of contaminated clothing immediately. Keep service products away from children.



Environmental protection

Incorrect handling of service products may endanger human life and the environment. Service products must not be allowed to enter the sewage system, surface water, ground water or soil. Dispose of service products and containers and components that have come into contact with service products (e.g. filters) in an environmentally responsible manner. Comply with legal requirements.



Caution:

Biodiesel (FAME) may be used as an alternative to diesel fuel only in buses that have been approved for operation with biodiesel (FAME) ex works (custom requirement/code) or as a result of a conversion measure.



Caution:

The biodiesel (FAME) used must comply with EN 14214. The use of pure vegetable oils is not permitted.

AdBlue service product

AdBlue service product

AdBlue is a non-flammable, non-toxic, colourless, odourless, water-soluble liquid.



Caution:

Use only AdBlue compliant with DIN 70 070. Special additives are not permitted.



Caution:

If, during a top-up, AdBlue comes into contact with painted or aluminium surfaces, rinse down these surfaces with water immediately.

Properties of AdBlue at high temperatures



Note:

Ammonia vapours may be produced if the content of the AdBlue tank is heated to over 50 °C for a lengthy period (e.g. as a consequence of direct sunlight).



Note:

Ammonia vapours have an acrid odour. For this reason, you should avoid inhaling any ammonia vapours that may escape when you remove the AdBlue filler cap. Ammonia vapours are neither toxic nor hazardous to health in this concentration.

Properties of AdBlue at low temperatures



Note:

AdBlue freezes at a temperature of approximately -11 °C. The bus is equipped with an AdBlue preheating system as standard. Winter operation is thus ensured, even at temperatures below -11 °C.

AdBlue additives



Caution:

Do not add any additives to AdBlue. Do not dilute AdBlue with tap water. Doing so could destroy the exhaust gas cleaning system. Damage to the exhaust gas cleaning system caused by additives or tap water will invalidate the warranty.

Storage



Caution:

For the storage of AdBlue, use only containers made from high-alloy CrNi steels or MoCrNi steels complying with DIN EN10088-1/2/3. Containers made of aluminium, copper, cupriforous alloys and non-alloyed or galvanised steels are not suitable for the storage of AdBlue. If stored in such containers, AdBlue could dissolve out constituents of these metals and destroy the exhaust gas cleaning system. The vehicle warranty will be invalidated if damage to the exhaust gas cleaning system is found to have been caused by constituents dissolved out of non-approved storage containers.

Winter operation with diesel fuels for buses with fuel-lubricated injection systems

Disposal of AdBlue



Environmental protection

Observe country-specific legislation and requirements governing the disposal of AdBlue.

AdBlue purity



Note:

It is prohibited to return to the tank any AdBlue that has been pumped out, e.g. during a repair, because the purity of the liquid would no longer be guaranteed.

Winter operation with diesel fuels for buses with fuel-lubricated injection systems

WARNINGS:



Danger.

Risk of fire and explosion. Petrol must never be mixed with diesel fuel.



Danger.

Risk of fire and explosion. If paraffin has already separated and this has caused operational malfunctions, do not under any circumstances heat components using sources of heat, e.g. heaters, heat radiators, hot air blowers or blow torches. Risk of damage to components. Risk of fuel escaping.



Note:

Please observe the further notes in the text.

▷ Further notes on winter operation with diesel fuel can be found on Mercedes-Benz Specifications for Service Products sheet 137.0.

Low-temperature characteristics of diesel fuels

Low-temperature characteristics of diesel fuels

At subzero outside temperatures, the filterability or fluidity (low-temperature characteristics) of diesel fuel could deteriorate as a consequence of paraffin crystal separation.

On average, the temperature values for filterability (low-temperature characteristics) of diesel fuel are 0 °C in the summer, -20 °C in winter and -10 °C in the transition period. During particularly cold spells or if diesel fuel with inadequate low-temperature behaviour is used for refuelling, there is a risk of malfunctions occurring if no precautions are taken to prevent paraffin separation.

Diesel fuels available by region

If a cold spell is encountered when driving from warmer to colder regions, it is essential to change over immediately to the diesel fuel conventionally used in the region.

Replacing the fuel filter

With the use of diesel fuels having a high water content, the fuel filter should be replaced with a new one before the onset of winter. This is a precautionary measure to prevent the fuel filter from icing up.

Addition of petrol

It is prohibited to add petrol as a flow improver for three reasons:

- Buses with unit pumps could be damaged from lack of lubricant when petrol is added.
- The addition of petrol changes the hazard category for flammable liquids from A III for diesel fuel to A I for petrol fuels. There is a greater risk of explosion.
- Petrol has an adverse effect on the starting behaviour of a diesel engine. This may lead to serious starting problems at very low temperatures.



Danger.

Risk of fire and explosion. Petrol must never be mixed with diesel fuel.

Addition of flow improvers

In the case of winter-grade diesel fuels with an operating reliability of $-20\text{ }^{\circ}\text{C}$ and below, the addition of a flow improver does not promote any further improvement in low-temperature characteristics because these fuels are already saturated with flow improvers.

The following must be taken into account when flow improvers are used:

- Summer diesel fuel: should be added when the fuel temperature is at least $+8\text{ }^{\circ}\text{C}$.
- Winter diesel fuel: should be added when the fuel temperature is at least $0\text{ }^{\circ}\text{C}$.
- Since diesel fuels vary in their properties, it cannot be guaranteed that every diesel fuel will react positively to the addition of flow improvers. In the case of particularly cold-resistant winter-grade diesel fuels, there could even be a deterioration in low-temperature characteristics. The subsequent addition of flow improvers is not recommended in this instance.

Measures required in the event of inadequate low-temperature characteristics

If no diesel fuel with adequate low-temperature characteristics is available, it is possible to mix the necessary proportion of kerosene with the diesel fuel, preferably before the onset of the cold weather. Each 5 % addition of kerosene by volume improves low-temperature characteristics by approximately $1\text{ }^{\circ}\text{C}$. The maximum permissible proportion of kerosene in the fuel mixture is 50 % by volume.



Danger.

Risk of fire and explosion. For safety reasons, only mix the kerosene with the diesel fuel in the bus fuel tank.

Measures required in the event of pre-existing paraffin separation



Danger.

Risk of fire and explosion. The addition of kerosene reduces the flash point of the diesel fuel. The dangers associated with working with this fuel mixture are therefore increased. Risk of fire and explosion. Comply with the relevant safety regulations.



Note:

First add the kerosene to the fuel tank, then the diesel fuel. Then let the engine run for some time so that the fuel mixture is dispersed throughout the whole fuel system.



Note:

Engine output may be degraded in line with the amount of additive. The amount of additive should therefore be kept as low as possible under consideration of prevailing outside temperatures.

Measures required in the event of pre-existing paraffin separation

The addition of flow improvers or kerosene has no effect if paraffin separation has already occurred. Paraffin separation must first be reversed to remedy the situation. This is achieved by heating the entire fuel system.

The fuel system should be heated by parking the bus in a heated indoor facility for a long period. The covers, of the engine compartment for instance, should be opened to accelerate the process.



Danger.

Risk of fire and explosion. Do not under any circumstances heat components using artificial sources of heat, e.g. heaters, heat radiators, hot air blowers or blow torches. Risk of damage to components. Risk of fuel escaping. Risk of fire.

Winter operation with FAME biodiesel

DIN EN 14214 demands the following filterability (low-temperature characteristics) temperature limits for FAME:

- 15 Apr to 30 Sep: 0 °C
- 01 Oct to 15 Nov: -10 °C
- 16 Nov to 28 Feb: -20 °C
- 01 Mar to 14 Apr: -10 °C

A fuel preheating system is required if no FAME biodiesel fuel with adequate low-temperature characteristics is available or if lower outside temperatures prevail in the region of use.



Note:

Adding flow improvers for conventional diesel fuels or blending in kerosene does not improve the low-temperature characteristics of FAME.

Opening/closing the fuel filler cap



Caution:

FAME biodiesel fuels are powerful solvents. For this reason, do not allow these fuels to come into contact with painted bus components.

Opening/closing the fuel filler cap

▷ Observe the general information on refuelling.



M88_00-0067-01

▶ Open the flap (1)

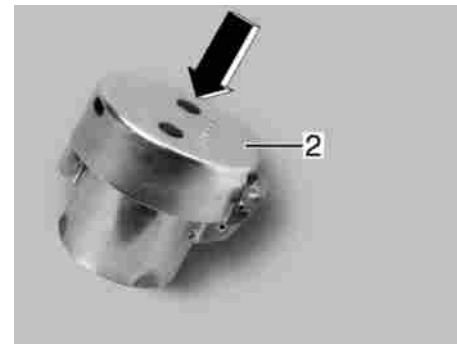

M47_00-0035-01

▶ Push fuel filler cap (2) downwards against the spring pressure.

Opening/closing the fuel filler cap



M47_00-0036-01

- ▶ Tilt the fuel filler cap.



M47_00-0037-01

- ▶ Open the fuel filler cap.

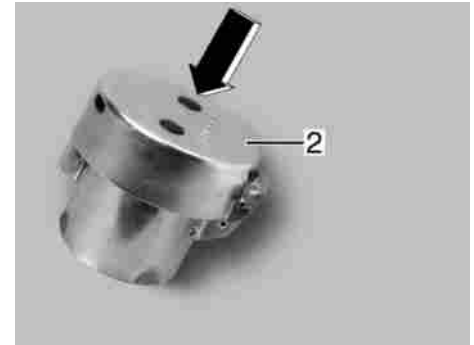

M47_00-0035-01

- ▶ Press fuel filler cap (2) downwards until the catch engages.

BlueTec exhaust gas cleaning system

The BlueTec exhaust gas cleaning system essentially comprises a supply tank, a catalytic converter and an AdBlue metering system. It is monitored and controlled electronically. Pollutants in the exhaust gas are converted into environmentally friendly substances through a combination of the addition of AdBlue and the effect of the catalytic converter in the exhaust silencer.

To function correctly, the BlueTec exhaust gas cleaning system requires the addition of a reducing agent (AdBlue). The addition of AdBlue does not form part of the routine scope of bus maintenance – it is the responsibility of the vehicle operators to ensure that the AdBlue supply tank is regularly replenished. Filling and operating the bus with AdBlue is mandatory for compliance with emission regulations and is thus one of the conditions for the road traffic approval of the bus. The road traffic approval of the bus will be invalidated if the bus is op-

erated without AdBlue. Legally, the bus would no longer be permitted to be operated on public roads. In some countries, operation of the bus without AdBlue may be considered to be a criminal offence or a violation of administrative law punishable by fine. Support in the purchase or operation of the bus, e.g. tax relief, road tax, may also be invalidated retrospectively. This may be the case both in the country in which the vehicle is registered and in other countries in which the vehicle is operated.



Danger.

It is essential that work relevant to safety or work on safety-related systems be carried out at a qualified specialist workshop.



Danger.

Always have maintenance work carried out at a qualified specialist workshop which has the necessary knowledge and tools.



Note:

AdBlue freezes at a temperature of approximately -11 °C. The bus is equipped with an AdBlue preheating system as standard. Winter operation is therefore guaranteed, even at temperatures of below -11 °C.



Environmental protection

AdBlue is biologically degradable. Unless it is handled properly, however, AdBlue constitutes an environmental hazard. Do not allow AdBlue to enter the sewage system, surface water, ground water or soil in significant volumes.

BlueTec exhaust gas cleaning system



Danger. Risk of poisoning and injury.

AdBlue is not considered a hazardous substance according to German regulations governing hazardous substances. Nevertheless, certain points should be observed when handling AdBlue.

The AdBlue line system and the related system components are pressurised while the engine is warm. There is a risk of scalding from hot AdBlue spraying out if the line system is suddenly opened. There is also the risk of skin irritation or damage to the eyes if AdBlue comes into contact with the skin or eyes.

- Wear protective gloves
- Wear protective clothing
- Wear eye protection
- Work on the exhaust gas aftertreatment system should not be commenced until approximately 4 minutes have passed as individual lines continue to be flushed with compressed air even after the engine has been switched off.
- Turn the ignition switch to the OFF position and remove the key before

work is carried out on the SCR system.

- Allow the AdBlue line system to cool down
- Open line connections and system component covers/caps slowly.
- Capture any AdBlue that escapes in a suitable container and dispose of it in an environmentally responsible manner.
- Do not pour AdBlue into drinks containers.
- Wipe up any spilled AdBlue, especially as there is a risk of slipping.
- AdBlue collected in this way must not be poured back into the AdBlue supply tank.
- If AdBlue comes into contact with the skin, rinse affected areas of skin copiously with clean water.
- Quickly change out of clothing that has come into contact with the substance.
- In case of contact with the eyes, rinse them immediately and copiously with clean water and seek medical attention if necessary.

- In cases where AdBlue enters the mouth or is swallowed, rinse the mouth with clean water then drink copious amounts of water.
- Seek medical attention if symptoms persist.

Filling with AdBlue

i Note:

An accidental filling of the AdBlue supply tank with diesel fuel and vice versa is prevented by various technical precautionary measures.

i Note:

AdBlue is consumed at a rate of approximately 5 % of the rate of diesel fuel consumption. It is recommended that the AdBlue supply tank also be refilled at every regular refuelling stop.

! Caution:

Use only AdBlue compliant with DIN 70 070. Special additives are not permitted.

**Caution:**

If, during a top-up, AdBlue comes into contact with painted or aluminium surfaces, rinse down these surfaces with water immediately.

**Note:**

AdBlue freezes at a temperature of approximately $-11\text{ }^{\circ}\text{C}$. The bus is equipped with an AdBlue preheating system as standard. Winter operation is thus ensured, even at temperatures below $-11\text{ }^{\circ}\text{C}$.

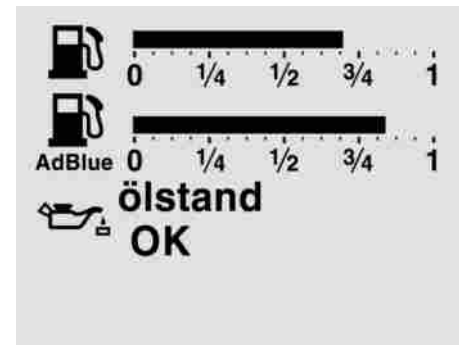

M54_00-1132-01

► Reading the AdBlue level

**Note:**

To read the AdBlue level, call up this operating display using the display control pushbutton on the instrument panel.

Operating/malfunction displays: fuel system

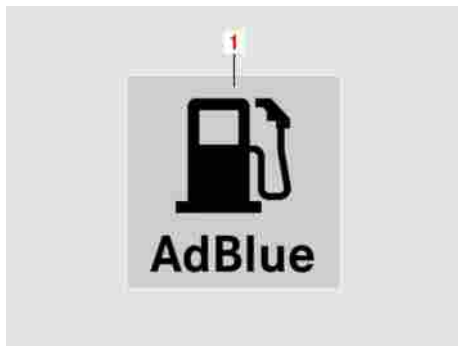

M47_00-0056-71

- ▶ If the level in the AdBlue supply tank falls to the reserve level, this icon (1) appears on the screen to remind the driver that an AdBlue top-up is due.
- ▶ The driver is informed by an icon on the screen (see illustration) in conjunction with a yellow alert if the AdBlue supply tank runs empty or if there is a malfunction in the BlueTec exhaust gas cleaning system. In this event, it is necessary to top up the AdBlue level without delay or remedy the fault.

- ▶ Fill the supply tank with AdBlue.



Note:

The filler opening for the AdBlue supply tank is located to the rear of the front axle (CITARO K, CITARO, CITARO M and CITARO L) or to the rear of the articulation (CITARO G, CapaCity) on the right-hand side when viewed in the direction of travel.

Operating/malfunction displays: fuel system

Fuel reserve



Fuel level has reached the reserve level.

AdBlue level



If the level in the AdBlue supply tank falls to the reserve level, this icon appears on the screen and a yellow warning level malfunction message is displayed to remind the driver that an AdBlue top-up is due.

Exhaust gas cleaning malfunction



The malfunction indicator lamp lights up in the event of a malfunction in the exhaust gas cleaning system (SCR system).

Note:

The indicator lamp is located in the instrument cluster.

Danger.

Have the malfunction rectified by an EvoBus Service Partner immediately.

Fault in the exhaust gas cleaning system

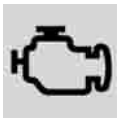

The malfunction indicator lamp flashes in the event of a fault in the exhaust gas cleaning system (display if permissible NOx values exceeded) or if the AdBlue supply tank runs empty. If the malfunction message was triggered by the AdBlue supply tank running empty, it is necessary to top up the AdBlue level immediately. If the AdBlue supply tank has run empty, the driver must have actively acknowledged the AdBlue level operating display (see above) at some time previously.

Note:

The indicator lamp is located in the instrument cluster.

Danger.

Have NOx faults rectified immediately by an EvoBus Service Partner.

Engine torque reduction



In the event of an NOx fault (display if permissible NOx concentration exceeded), engine torque will be reduced the next time the bus moves off from stationary. In this situation, a fault is also present in the exhaust gas cleaning system, i.e. the malfunction indicator lamp flashes. If the fault was caused by the AdBlue supply tank running empty, the AdBlue level operating display (see

Function of the accident data recorder (ADR) (option)

above) is also displayed. The AdBlue supply tank must be filled immediately.



Note:

The icon displayed on the screen and the yellow warning level A malfunction display are accompanied by the “Exhaust system engine output reduced” message.



Danger.

Have NOx faults rectified immediately by an EvoBus Service Partner.

Diesel particulate filter (DPF) operating notifications



Displayed if the exhaust counterpressure of the diesel particulate filter (DPF) exceeds a defined limit value.



Note:

The icon is accompanied by the message “Visit workshop”, a yellow warning level B malfunction display.

Function of the accident data recorder (ADR) (option)

- ▶ The accident data recorder (ADR) is a system for detecting and recording accidents and driving events, e.g. pulling away against a kerb or sudden braking.
- ▶ The accident data recorder (ADR) is activated automatically when the ignition is switched on.



Note:

The accident data recorder (ADR) remains active for 3 days after the ignition has been switched off and continues to register all vehicle movements (e.g. parking collisions).

Function of the accident data recorder (ADR) (option)



M54_00-1502-71

- ▶ As soon as the ignition is switched on, the accident data recorder (ADR) carries out a self-test and provides audible notification of the current operating status or the presence of a hardware fault.

i **Note:**

A brief, one-off audible signal (buzzer in the control panel) (4) indicates that the accident data recorder (ADR) is ready for operation.

i **Note:**

Indicator lamp (2) lighting up and a brief, one-off buzzing sound means that at least one event is stored.

i **Note:**

A sequence of four long buzzes indicates that the accident data recorder (ADR) has detected a parking collision. Check your vehicle for damage.

i **Note:**

Eight short buzzes mean that the memory of the accident data recorder (ADR) is almost full to capacity. Export the events and have the memory cleared.

i **Note:**

Ten short buzzes mean that the accident data recorder (ADR) has malfunctioned. Similarly, a malfunction is present if no signal sounds.

- ▶ Following any critical traffic or accident situation, it is possible to record an entry manually.

i **Note:**

When pushbutton (1) is pressed following an accident, the event (approximately 43 seconds before, during and after the accident) is stored and remains write-protected for an extended period.

Anti-jackknifing protection during forward travel

Anti-jackknifing protection during forward travel



Risk of accident. If the rear car begins to swing from side to side, the bus must be stabilised by braking. If a malfunction occurs in the anti-jackknifing protection system (red warning lamp in conjunction with the “Anti-jackknifing protection” symbol), it is permissible to drive the bus as far as the nearest workshop but only in exceptional cases, in favourable weather conditions (non-skid road surface) and at a speed of no more than 12 mph (20 km/h). In all other cases the bus must be towed.



If a malfunction occurs in the anti-jackknifing system, indicated by a red warning lamp in conjunction with the “Anti-jackknifing system malfunction” malfunction display, the vehicle is automatically braked down to a speed of 30 mph (50 km/h).

- ▶ If the bus articulation angle and steering angle are divergent during forward travel, the anti-jackknifing protection responds as follows.

The buzzer sounds.

Anti-jackknifing protection is activated.



The following is shown on the screen: “Anti-jackknifing protection active”.

- ▶ If the driver countersteers in this situation, the anti-jackknifing protection responds as follows:

Anti-jackknifing protection is deactivated.



The following indication display on the screen goes out: “Anti-jackknifing protection active”.

Anti-jackknifing protection during reverse travel

- ▶ If the bus articulation turns to a specific angle and reaches a specific speed during reverse travel, the anti-jackknifing protection responds as follows:

The buzzer sounds.

The accelerator pedal is locked.

Anti-jackknifing protection is activated.

The bus stop brake is activated.

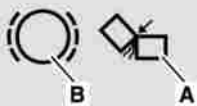

The bus can now be moved forwards again.

i **Note:**

If a speed of approximately 6 mph (10 km/h) is exceeded when reversing in a straight line, operation of the accelerator pedal is automatically restricted. This prevents further acceleration. If a higher speed is reached despite this measure, the bus stop brake is activated. As soon as the speed falls below 5 mph (9 km/h), the bus stop brake is released and operation of the accelerator pedal is no longer restricted.

M54_00-0241-01

The following is shown on the screen: “Anti-jackknifing protection active” (A) “Bus stop brake active” (B).

- ▶ If the driver countersteers in this situation or presses transmission range “1” to “D”, the anti-jackknifing protection responds as follows:

Anti-jackknifing protection is deactivated.

The following indication display on the screen goes out: “Anti-jackknifing protection active” (A), “Bus stop brake active” (B).

Stop request



Note:

Precondition: electrical system on, doors closed.



M72_00-0037-01

- ▶ Passenger: press pushbutton (1).
A signal sounds.

Ramp request



M82_00-0005-01

“Bus stopping” or “Stop” (2) on the passenger information screen lights up.



The following is shown on the screen:
“Stop request” (flashing).



Note:

The “Bus stopping” or “Stop” passenger information, and the “Stop request” indication display on the screen, go out when a door is opened.

Ramp request



Note:

Precondition: electrical system on.



M72_00-0038-01

► Passenger: press pushbutton (1).

A signal sounds.

Safety precautions for the operation of folding/cassette ramps, various lift models (options)



M82_00-0005-01

“Bus stopping” or “Stop” (2) on the passenger information screen lights up.



The “Wheelchair” symbol is displayed on the screen.



Note:

Depending on the option, the wheelchair symbol is either a flashing or a static display.



Note:

The “Bus stopping” or “Stop” passenger information goes out when a door is opened.



Note:

If no ramp is fitted, the “Wheelchair” symbol on the screen goes out after all the doors have closed.



Note:

If a ramp is fitted, the “Wheelchair” symbol goes out after the door with the ramp has closed.

Safety precautions for the operation of folding/cassette ramps, various lift models (options)



Danger.

Park the bus in such a way that there can be no possible risk to the person being transported, to the operator or to other road users while the ramp is in operation.



Danger.

The parking brake must be applied.



Danger.

Do not exceed the maximum permissible height span.

Folding the ramp in/out



Danger.

Do not fold the ramp out or in (extend or retract it) if anyone is within the ramp's range of movement. Do not subject the ramp to load while it is in motion.



Danger.

Observe the maximum payload.



Note:

Before the ramp is used, it must be tested for suitability of use, state of repair and possible damage.



Note:

In the front doorway of buses equipped with a lift, no passengers are permitted to remain in the area up to the hinged barrier while the vehicle is in motion.

▷ For notes on safety and operation, also refer to the manufacturer's operating instructions.

Folding the ramp in/out



Note:

Precondition: bus stationary, door open.



Caution:

Observe operating notices and load-bearing capacity plates.

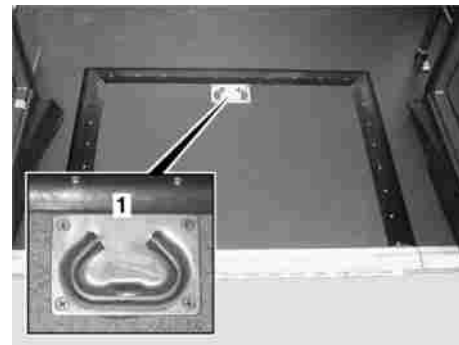

M72_00-0029-01

- ▶ Lift up the ramp from the outside using handle (1) and fold the ramp out.



Note:

It is no longer possible to operate the door with the ramp folded out.

Folding the ramp in/out



Danger.

The bus must not be moved while the ramp is in the folded-out position.



M72_00-0030-01

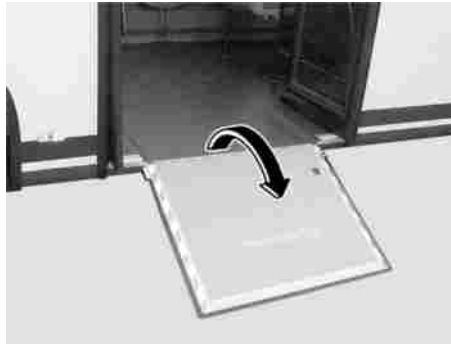

M72_00-0032-01

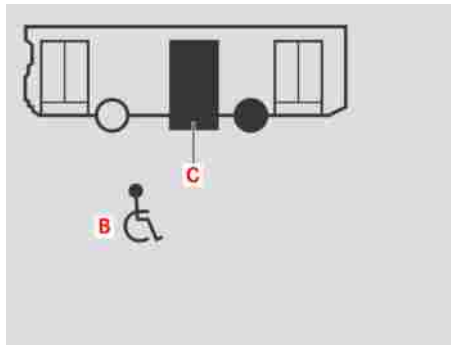

M54_00-1354-71

The following is shown on the screen:
“Ramp folded out” (C).



Note:

“Wheelchair” symbol (B) is displayed when the ramp has been requested.



The ramp indicator lamp in the instrument cluster lights up.



The ramp is folded back in in reverse order.

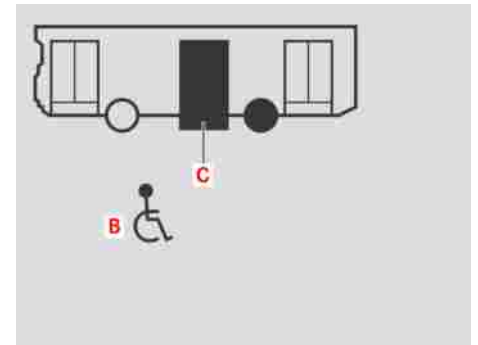

M54_00-1354-71

The “Ramp folded out” indication display (C) on the screen goes out.

Pulling out/sliding in the platform



Note:

The “Wheelchair” symbol (B) goes out after the door with the ramp has closed.



The ramp indicator lamp in the instrument cluster goes out.

- ▶ Ramp malfunction



Note:

A malfunction is displayed on the screen if the ramp has not been folded in fully but the door is closed.

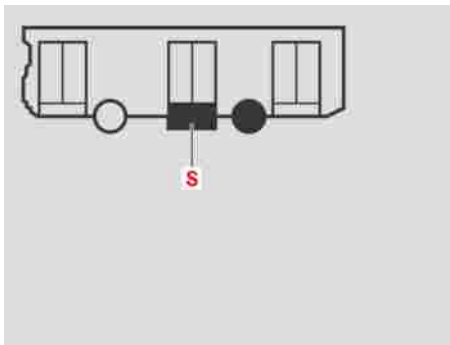

M54_00-1353-71

The following is shown flashing on the screen: “Ramp malfunction” (S).

Pulling out/sliding in the platform



Note:

Precondition: bus stationary.



Caution:

Observe operating notices and load-bearing capacity plates.



Note:

With the range of options available, there may be a different ramp model installed on the bus and its operating instructions may differ from the instructions provided here.

Pulling out/sliding in the platform



M72_00-0405-71

- ▶ Release flap lock (1) (turn clockwise).



Note:

If the electrical system is switched on, releasing flap lock (1) on ramp cover flap (2) activates the bus stop brake.



Danger.

The bus must not be moved while the ramp is in the extended position.

The ramp indicator lamp in the instrument cluster lights up.

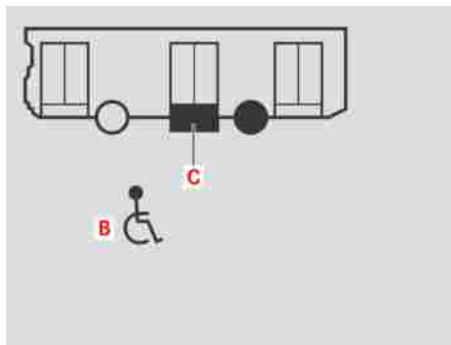

M54_00-1356-71.tif

The following is shown on the screen: “Ramp extended” (C).



Note:

“Wheelchair” symbol (B) is displayed when the ramp has been requested.



M72_00-0401-71

- ▶ Release the platform.



Danger.

Risk of entrapment

Fold ramp cover flap (2) open in the direction of the arrow and briefly push it down.

Pulling out/sliding in the platform



M72_00-0402-71



Danger.

Platform (A) slides forward approximately 20 cm.

- ▶ Move the platform into position.

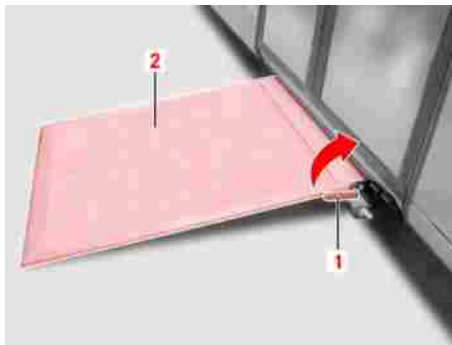

M72_00-0404-71

- ▶ Pull platform (2) out as far as the stop and lower it to the ground. To move the ramp into position, operate lever (1) in the direction of the arrow.

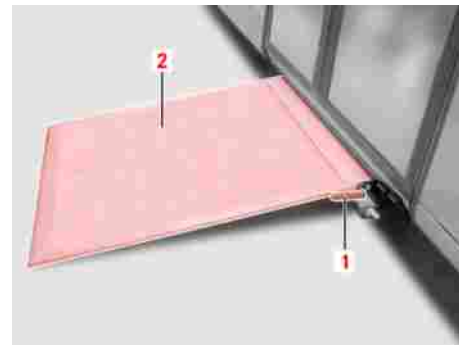

M72_00-0403-71

- ▶ Retracting the ramp

Raise platform (2) by the front edge and slide it in. Towards the end, push harder to overcome the spring force until platform (2) engages.



Caution:

Risk of entrapment

Retracting/extending the electric cassette ramp



M72_00-0405-71

- ▶ Close ramp cover flap (2), engage flap lock (1) (turn anti-clockwise)

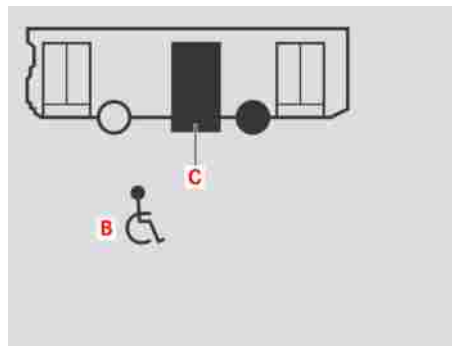

M54_00-1354-71

The “Ramp extended” indication display (C) on the screen goes out.



“Wheelchair” symbol (B) goes out after all the doors have closed.



The ramp indicator lamp in the instrument cluster goes out.

Retracting/extending the electric cassette ramp



Note:

Precondition: bus stationary, door closed.



Caution:

Observe operating notices and load-bearing capacity plates.



Note:

Due to the range of optional equipment available, which includes various ramp models, the operating instructions for the ramp in your bus may differ from the instructions provided here.

- ▶ Turn the ramp key switch to position 1

Retracting/extending the electric cassette ramp



Note:

During ramp operation, the bus stop brake remains activated until the ramp is fully retracted.



Danger.

The bus must not be moved while the ramp is in the extended position.

- ▶ Press the ramp switch.



Note:

Door operation is disabled while the ramp is in use.

The ramp indicator lamp in the instrument cluster lights up.

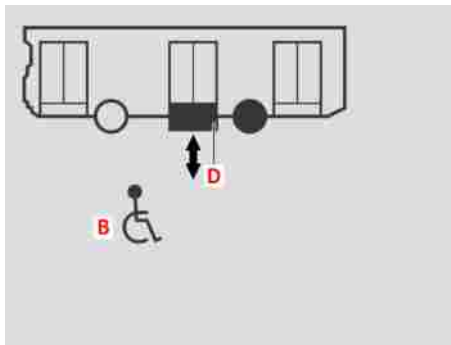

M54_00-1355-71

The following appears on the screen: “Ramp in use” (D), the arrow indicates that the ramp is in motion.



Danger.

Risk of entrapment: Make sure that no persons or objects are present between the bus superstructure and the road surface.



Caution:

If the ramp meets an obstacle, it will retract automatically. In this event, ramp operation has to be resumed from the beginning.



Note:

“Wheelchair” symbol (B) is displayed when the ramp has been requested.

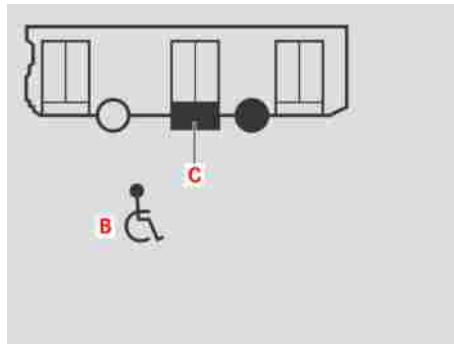

M54_00-1356-71.tif

Ramp fully extended.

Retracting/extending the electric cassette ramp

i Note:

The door can be opened.

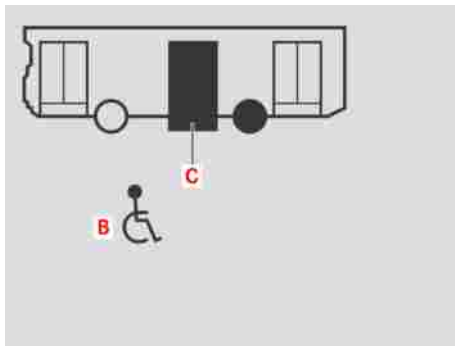

M54_00-1354-71

Door open

► Retracting the ramp

i Note:

The ramp retracts automatically after the door has closed.

i Note:

“Wheelchair” symbol (B) goes out after the door has closed.

i Note:

Ramp movement is interrupted if the ramp platform is subjected to load during ramp operation.

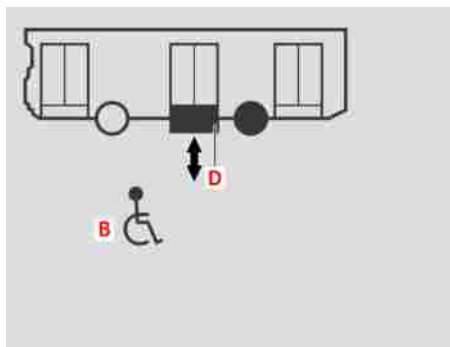

M54_00-1355-71

The following appears on the screen:
“Ramp in use” (D), the arrow indicates that the ramp is in motion.

The ramp indicator lamp in the instrument cluster goes out.

The “Ramp extended” indication display (D) on the screen goes out.

Opening the hinged window

Opening the hinged window



M67_00-0012-01

- ▶ Open the window inwards using the handle.

Air circulates in the passenger compartment without the need for a fan when the hinged windows and roof hatches are open.

Care and cleaning



Note:

Observe the laws and regulations in all countries concerned.



Danger.

Risk of injury. Observe the safety regulations when working on the bus (e.g. operational instructions, environmental laws and regulations, work safety and accident prevention regulations, etc.).



Danger.

Risk of poisoning. Observe the instructions for use of the care and cleaning products.



Danger.

Risk of poisoning. Always keep care and cleaning products sealed and out of the reach of children.



Danger.

Risk of poisoning. Diesel, regular and premium-grade fuels are harmful to health. They should not be used as a cleaning product.



Danger.

Risk of fire. Diesel, regular and premium-grade fuels are highly flammable. They should not be used as a cleaning product.



Danger.

Do not use round-spray jets to clean tyres or suspension air bags. The pulsating jet of water could cause concealed damage to the tyre substructure or suspension air bags. This damage would not become

apparent until much later and could cause the tyre or suspension air bag to burst. This could result in you losing control of your bus and causing an accident, thereby injuring yourself and other people.



Caution:

We recommend that only tested and approved care products should be used. Information about acceptable care products can be obtained from your EvoBus Service Partner.



Caution:

For cleaning work in the engine compartment, the use of cleaning agents containing acetone or chloroethylene is prohibited.



Caution:

Stone chips and areas of soiling, especially insect remains, bird droppings, tree resins, oils and greases, fuels or tar stains should be removed immediately using approved care products.



Caution:

The bus must be cleaned more frequently in winter to remove salt residues from road gritting.



Environmental protection

Dispose of empty containers, cleaning cloths and polishing wads in an environmentally responsible manner.

Tilting the rear seats



Note:

The rear seats can be tilted forwards to permit cleaning of the rear area.

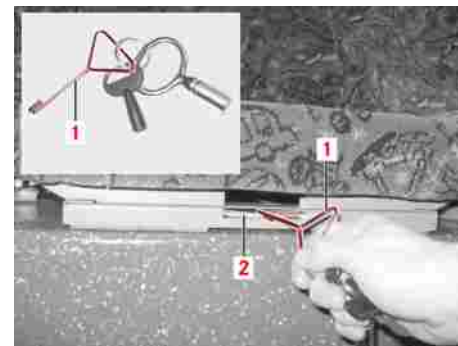

M91_00-0027-71

- ▶ Use hook key (1) to release the rear seat by pulling cable (2), and fold the rear seat forwards.

It is now possible to clean the area behind the seats.

Skibox (option)



Note:

After cleaning, be sure to fold the seat back and re-engage it.

Skibox (option)



Note:

The pictures are for illustration purposes only. Actual installation arrangements may differ.



Danger.

The skibox must be transported, stored and assembled only by means of the assemblies and fastening elements provided.



Danger.

Fitting a skibox alters the length of the bus, and any reversing aid (e.g. ParkPilot) in the bus will no longer be operational.



Danger.

An emergency exit through the rear window must still be possible with the skibox fitted. Maximum permissible height to top edge of skibox: 2.2 m above road surface with bus suspension at normal level.

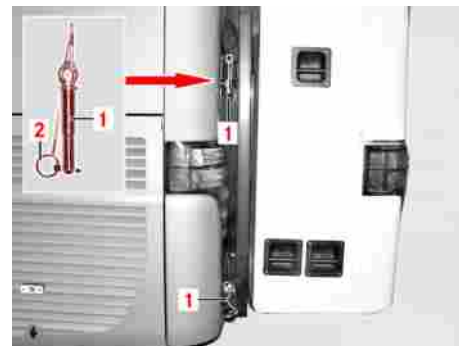

M88_00-0019-01

- ▶ The skibox is fitted to the bus by pinning the four swivel bearings on the left and right-hand side of the outer frame to the bearing pedestals on the bus using pins secured with split pins (1).



Note:

To facilitate mounting onto the bus, a suitable lifting device should be used to raise the box to the correct height.

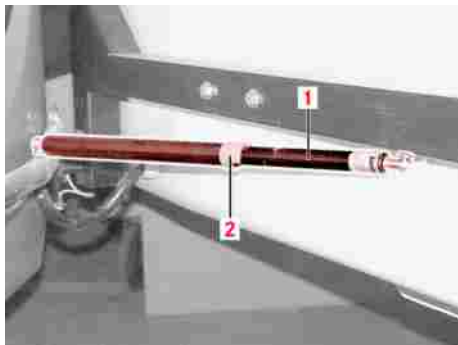

M88_00-0021-01

- ▶ Stake the lower locating eyes one after the other with one pin at a time, never both at once.



Danger.

Risk of injury. Make sure that rear gas strut (1) is prestressing the retaining bar.



M88_00-0019-01

- ▶ The skibox can be fitted only to buses equipped with the correct brackets.



Note:

After the skibox has been fitted, it is necessary to establish an electrical connection with the vehicle.



Danger.

Before the bus is driven, it is necessary to check that all pins (1) are firmly seated and correctly secured by split pin (2).



Danger.

All lighting equipment must be tested before the bus is driven. In addition, it is necessary to check that it is the rear foglamp on the skibox that is operational and not the foglamp on the bus itself.



Danger.

The skibox cover must remain closed and locked at all times while the bus is in motion.

Care and cleaning of covers and upholstery

Care and cleaning of covers and upholstery

Special notes on care and cleaning of covers and upholstery



Note:

Observe the instructions on your upholstery fittings and covers in the detailed description of the bus.



Caution:

Do not use cleaning products containing solvents (e.g. cleaning benzine, acetone, alcohol, etc.). This would damage covers and equipment parts made of plastic or foam beyond repair.



Caution:

Only use pH neutral care and cleaning agents to avoid bleaching out the colours.



Care/cleaning of fabric covers



Danger.

Observe the general information/safety notes in this section.



Note:

Regular care and basic cleaning help to maintain the value and high-quality appearance of fabric covers. For this reason, carry out basic cleaning regularly. Carry out basic cleaning more regularly, depending on use and the level of dirt.

Basic cleaning - weekly

- ▶ Vacuum the covers thoroughly following the nap of the fabric.



Caution:

Do not use vacuuming nozzles made of rubber or rubber components. These could pull threads out of the upholstery covers.

- ▶ Brush the fabric with a soft brush following the nap of the fabric.

Basic cleaning - every six months

- ▶ First carry out the weekly basic cleaning.
- ▶ Make a foam from a mild, lukewarm soap (e.g. from a mild-action detergent).
- ▶ Apply the foam evenly over all the covers using a soft, slightly damp sponge.
- ▶ Wait until the freshly cleaned covers are completely dry.



Caution:

The covers must be completely dry before they are used again. Permanent pressure marks could otherwise form.

- ▶ Brush following the nap of the fabric using a soft brush, without applying pressure.

Malfunction display: yellow warning level A

Removing stains



Caution:

Remove dirt as quickly as possible to avoid permanent stains and prevent damage to the covers.

- ▶ Remove as much dirt as possible using a lint-free cloth.
- ▶ Work mild, lukewarm soap into the dirt using a soft sponge in circular movements from the outside in. Apply light pressure when doing this.



Note:

Always work on the dirt from the outside in so that the dirt is not spread over the fabric.

- ▶ Remove the soap used using a clean, soft sponge.
- ▶ Wait until the freshly cleaned areas are completely dry.



Caution:

The covers must be completely dry before they are used again. Permanent pressure marks could otherwise form.

- ▶ Finally, brush the cover and the cleaned areas using a soft brush following the nap of the fabric.



Caution:

If in any doubt, use a professional textile cleaning company.

Malfunction display: yellow warning level A



M54_00-1051-01

Malfunctions indicated by warning level A are displayed on screen (23) immediately in conjunction with yellow warning lamp (14). No warning signal sounds.



Caution:

In the event of a malfunction of this warning level, it is permissible to drive on carefully but the bus should be checked by an EvoBus Service Partner at the earliest opportunity.

Malfunction display: red warning level

▷ For further information about yellow warning level A malfunctions, please refer to the Operating Instructions.

Failure of the fire extinguishing system



M54_00-1592-71

Failure of the fire extinguishing system is indicated by symbol (1) in conjunction with the malfunction text “Fire extinguisher system failure” on the screen.



Note:

This malfunction triggers a “yellow warning level A” malfunction display.

Malfunction display: red warning level



M54_00-1051-01

Major malfunctions are displayed immediately on screen (23) in conjunction with red warning lamp (13) and remain active until the malfunctions themselves have been rectified. A warning signal also sounds. It is not possible to clear the malfunction display or switch to a different display mode.

Malfunction display: red warning level



Danger.

Risk of accident. In the event of red warning lamp malfunctions (13), the operating safety or roadworthiness of the bus is at risk. The driving and braking characteristics of the bus may change. The bus must be stopped immediately (traffic conditions permitting) and an EvoBus Service Partner must be notified.

▷ For further information about red warning level malfunctions, please refer to the Operating Instructions.

Triggering of the fire extinguishing system



M54_00-1591-71

The triggering of the fire extinguishing system (e.g. due to a fire in the engine compartment) is indicated by symbol (F) in conjunction with the malfunction text “Engine compartment fire” on the screen.



Danger.

Risk of accident. If this alert is displayed, bring the vehicle to an immediate halt (road and traffic conditions permitting), open all the doors and urge the passengers to disembark. Then operate the master safety switch and apply the parking brake (refer to Operating Instructions). Disembark and implement or arrange further measures as necessary.



Danger.

Keep the engine compartment flap closed for at least 5 minutes after a triggering of the fire extinguishing system.



Note:

This malfunction triggers a “red warning level” malfunction display.

Overview of vehicle key	76
Driver's area overview	78
Switches on the left section of the instrument panel	79
Switches on the right section of the instrument panel	81
Side panel	84
Instrument cluster	88
MTCO tachograph	92
DTCO tachograph	94
Tachograph	95
Location of emergency equipment	96
Windscreen washer fluid reservoir installation location	97

Overview of vehicle key

Overview of vehicle key



- 1 Key for the ignition switch
- 2 Key for: Doors, interior and exterior flaps
- 3 Key for (option): Doors, interior and exterior flaps
- 4 Key for key switch: Lowering system, ramp, disabled passengers' lift

Driver's area overview

Driver's area overview



Switches on the left section of the instrument panel

No.	Description	Page
1	Switches on the left section of the instrument panel	
2	Instrument cluster	88
3	Switches on the right section of the instrument panel	
4	Side panel	84
5	Steering column switch for light and wiper functions	
6	Steering column switch for retarder and cruise control (option)	104
7	Ignition switch	107
8	DTCO tachograph	94
8	MTCO tachograph	92

No.	Description	Page
9	Control panel for audio/video system in the driver's area and passenger compartment	

Switches on the left section of the instrument panel

**Note:**

The overview shows the maximum utilisation of the instrument panel with switches and instruments in their designated position. To accommodate the customisation requirements of the customer, the switches may have been assigned to different positions on the instrument panel.

Switches on the left section of the instrument panel



Switches on the right section of the instrument panel

No.	Description	Page
1	Sign box illumination switch	
1	Driver's area lighting switch	
2	Passenger compartment night lighting switch	
2	Raise bus above normal level pushbutton	
3	Retarder on/off switch (customer option)	
4	Retarder direct on/off switch (customer option)	
5	ASR (acceleration skid control) OFF pushbutton	
6	Steering limiter pushbutton	

No.	Description	Page
7	Hazard warning lamps switch	
8	Exterior loud-speaker on/off switch	
9	Communications radio 1/2 switch	
9	Communications radio tone call/speak pushbutton	
10	Rotary light switch	102
11	Passenger-compartment lighting position I+II switch	
12	Payment tray lighting switch	

Switches on the right section of the instrument panel

**Note:**

The overview shows the maximum utilisation of the instrument panel with switches and instruments in their intended positions. Switches can be assigned to another position on the instrument panel if this has been specified in the order.

Switches on the right section of the instrument panel



Switches on the right section of the instrument panel

No.	Description	Page
13	Display screen pushbutton - independent operation of the upper and lower areas of the display	
14	System/Info pushbutton	
15	Quit pushbutton	
15	Integrated bus information system "Quit" pushbutton	
16	Passenger loud-speaker on/off switch	
16	Integrated passenger information system "stop" switch/pushbutton	
17	Reset button	

No.	Description	Page
18	Bus stop brake pushbutton (option)	
19	Lower bus on entry side pushbutton	
20	Raise bus pushbutton	
21	Switch for holding the automatic doors open for pushchairs	
22	Ramp enable switch	
23	Disabled passengers' lift up/down pushbutton	
24	School bus mode switch	
25	Pushbutton for disabling the door leaves at all doors	

No.	Description	Page
25	Block door leaves on rear door 1 switch	
26	Door enable switch	
27	Pushbutton for opening/closing the doors from the inside	
28	Pushbutton for opening/closing door 1	
29	Pushbutton for opening/closing door 2	
30	Pushbutton for opening/closing door 3	

Side panel

Side panel



Note:

The overview shows the assignment of the side panel with control elements in their designated position; due to customer options, these may be assigned to another position on the side panel.

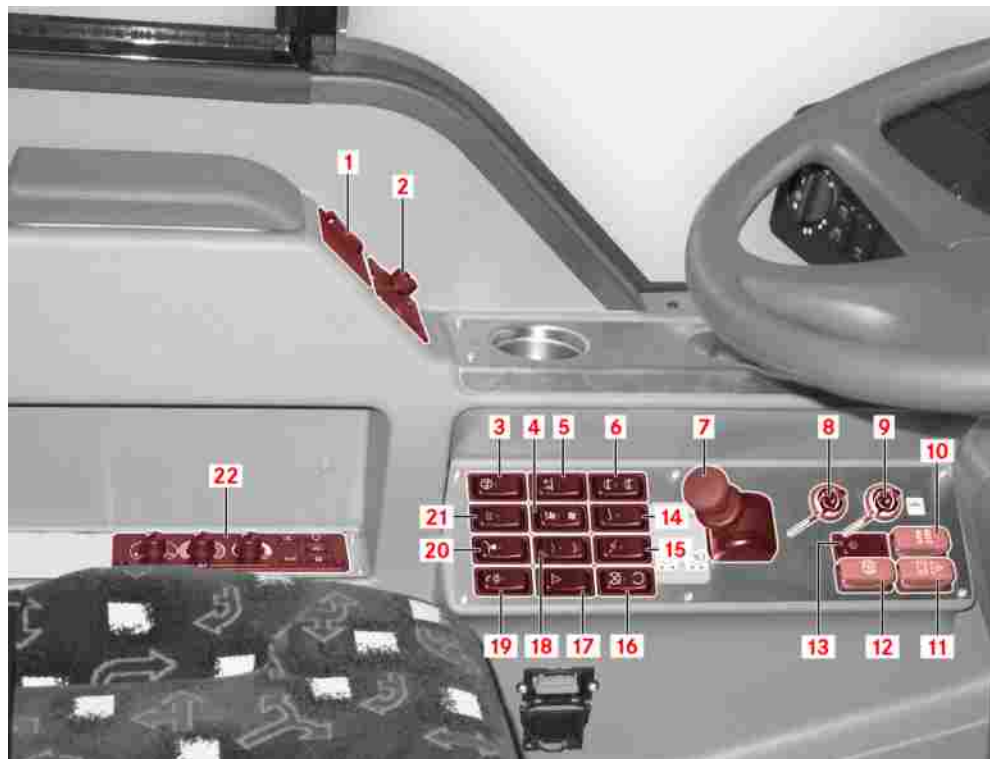

No.	Description	Page
1	Driver's window up/down push-button (for notes on safety and operation, refer to the "Driver's area controls" section of the Operating Instructions)	
2	Exterior mirror adjustment rotary switch	
3	Monitoring system switch	
4	Pushbutton for manual/automatic fans	
5	Pull-away aid on/off switch	
6	Switch for centring the trailing axle	

No.	Description	Page
7	Parking brake control lever (refer to the "Driver's area controls" section of the Operating Instructions)	
8	Ramp/disabled passengers' lift (option)	
9	Bus lowering key switch	
10	Drive-off lock emergency release switch	
11	Master safety switch (refer to the "Driver's area controls" section of the Operating Instructions)	
12	Parking brake emergency release switch	

No.	Description	Page
13	Steering column adjustment switch	
14	Electrical system on/off switch	
15	"Ignition on/off" switch	
16	Engine start/stop pushbutton	
17	Emergency valve rapid air-charging pushbutton	
18	Pushbutton for moving the roof hatches to the open/closed/air-in/air-out position (refer to the "Heating/ventilation/air-conditioning" section of the Operating Instructions)	

Instrument cluster

No.	Description	Page
19	Night lighting switch	
20	Exterior loud-speaker on/off switch	
21	Driver's window/mirror heating pushbutton (for notes on safety and operation, refer to the "Driver's area controls" section of the Operating Instructions)	

No.	Description	Page
21	Windscreen heating pushbutton (option, for notes on safety and operation, refer to the "Driver's area controls" section of the Operating Instructions)	
22	Heating/ventilation/air-conditioning control panel - driver's area	180

Instrument cluster



Danger.

Risk of accident. Stop immediately (traffic conditions permitting) if red warning lamp (4) lights up. The driving and braking characteristics of the bus may change. Notify an EvoBus Service Partner.



Caution:

While it is permitted to drive on carefully if yellow warning lamp (5) lights up, the bus should be checked at an EvoBus Service Partner at the earliest opportunity.



Note:

If a malfunction occurs in the anti-jackknifing system, indicated by the red warning lamp in conjunction with the "Anti-jackknifing system malfunction" malfunction display, the vehicle will be braked automatically down to a speed of 30 mph (50 km/h).

Instrument cluster

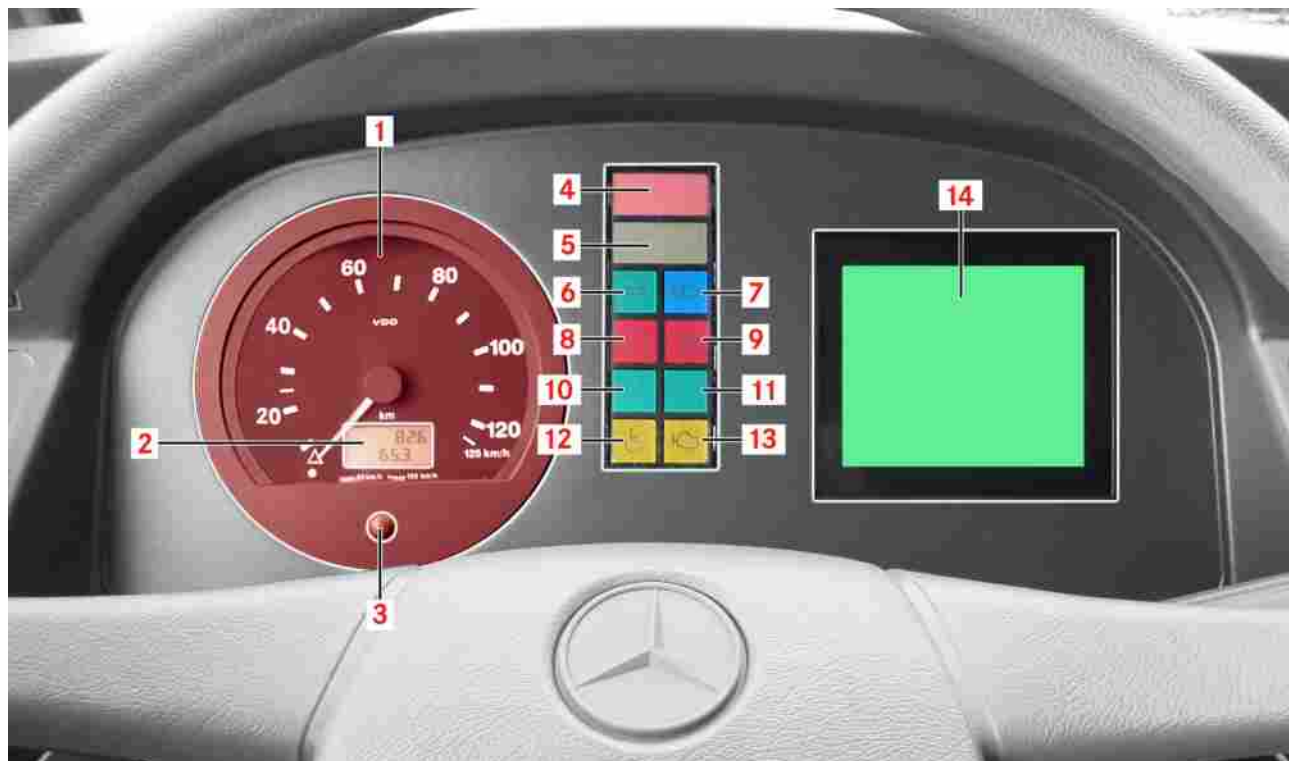

No.	Description	Page
1	Speedometer	
2	Display for total distance recorder/trip meter	
3	To reset the trip meter	
4	Red warning level malfunction lamp	
5	Yellow warning level malfunction lamp	
6	Turn signals/hazard warning lamps indicator lamp	
7	Headlamp flasher/main-beam indicator lamp	
8	Brake system malfunction indicator lamp	

No.	Description	Page
9	Hazard warning lamps indicator lamp	
10	Not assigned	
11	Not assigned	
12	Ramp indicator lamp	
13	Engine malfunction indication lamp (MIL)	
14	Screen (display)	

MTCO tachograph

MTCO tachograph

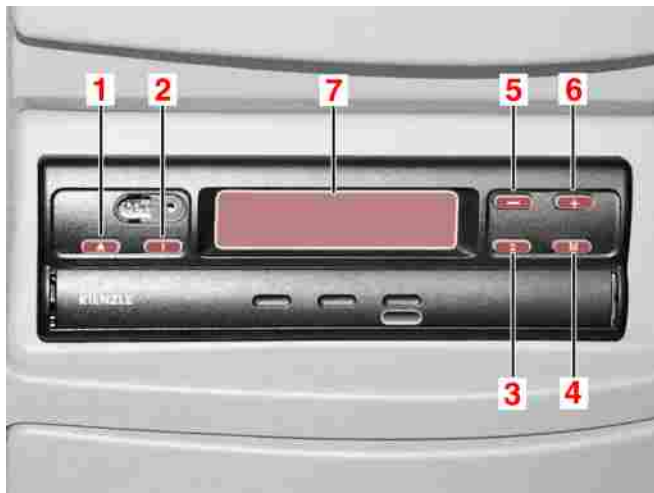

- 1 Button for opening the recording sheet tray: Driver 1 inserts his labelled recording sheet into the recording sheet tray and on top of the partition plate with the front side of the sheet facing upwards. Driver 2 inserts his labelled recording sheet into the recording sheet tray and underneath the partition plate with the front side of the sheet facing upwards. The recording sheets must be swapped over whenever the drivers change over.
- 2 Button for setting the required time group for driver 1: Press and hold the button until the required time group appears on the display screen.
- 3 Button for setting the required time group for driver 2: Press and hold the button until the required time group appears on the display screen.
- 4 Menu selection button (clock adjustment, fault indication, etc.): The time can be changed as desired. Summer and winter time has been programmed for several years in advance and the changeover takes place automatically.
- 5 Button (-): : Moving back within the menu
- 6 Button (+): : Moving forwards within the menu
- 7 Display screen (illuminated when ignition starter switch ON): The basic display (date, time and total distance) appears if there are no fault alerts. Flashing display screen = the time on the recording sheet tray does not correspond to the time on the display screen (e.g. after a voltage supply interruption or changeover from summer to winter time). The time is set automatically: remove the recording sheets and close the recording sheet tray without the recording sheets in it.
 - ▷ Observe the manufacturer's operating instructions.

DTCO tachograph

DTCO tachograph

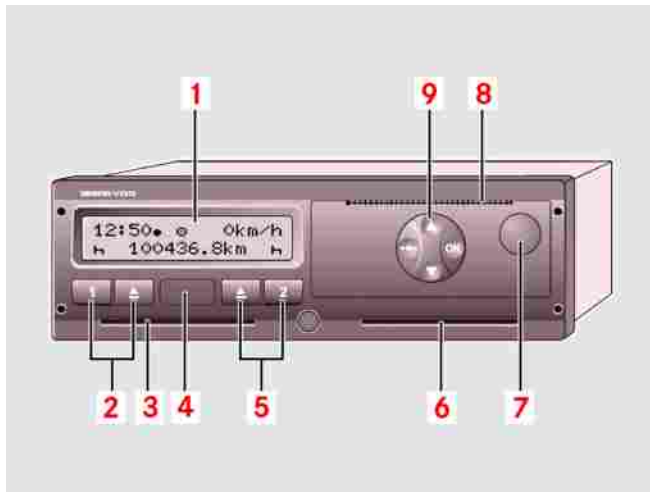

1 Display screen: Screen displays vary according to the operating state of the bus.

▷ refer to “Display variants” in the manufacturer's operating instructions.

2 Key panel, driver 1



Note:

Activity button, driver 1/card slot ejector button, driver 1

3 Card slot, driver 1: Driver 1, the current driver of the bus, inserts his driver card into card slot 1.

4 Download/calibration interface: There is an interface under the cover. This interface cannot be enabled without an inserted company card, control card or workshop card.

▷ For details, refer to “Access rights for tachograph cards” in the manufacturer's operating instructions.

5 Key panel, driver 2



Note:

Activity button, driver 2/card slot ejector button, driver 2

6 Card slot, driver 2: Driver 2, who is not currently driving the bus, inserts his driver card into card slot 2.

7 Printer drawer release button: This button is used to release the printer drawer, for example, for inserting a new roll of paper.

8 Tear-off edge

9 Menu buttons: Buttons for entering, displaying or printing data.

▷ Refer to “Calling up menu functions” in the manufacturer's operating instructions.

Tachograph



M68_00-0205-71

1 Speed display

2 Display field for total distance recorder/trip meter

3 To reset the trip meter

Press and hold to reset the trip meter to 0.

Location of emergency equipment

Location of emergency equipment



Note:

Observe the laws and regulations in all countries concerned.



Note:

The equipment is marked in the specified language.



Note:

The markings may differ in colour, design and content, depending on the legislation and specification in the countries concerned.



M86_00-0045-01

- ▶ In an emergency: press in sign (2) and pull out the cover.

Emergency equipment compartment (1) above the driver contains: 2 first-aid kits, 1 warning triangle, 1 warning lamp, 1 windproof flashlight (torch).



Note:

Use the key to open emergency equipment compartment (1) in normal circumstances (e.g. to inspect and correct the contents).



Note:

Observe the laws and regulations in all countries concerned.



M86_00-0046-01

- ▶ Open snap lock (2) and lift out the fire extinguisher.

Fire extinguisher (1) is ready for operation (observe operating instructions on the fire extinguisher).

Windscreen washer fluid reservoir installation location

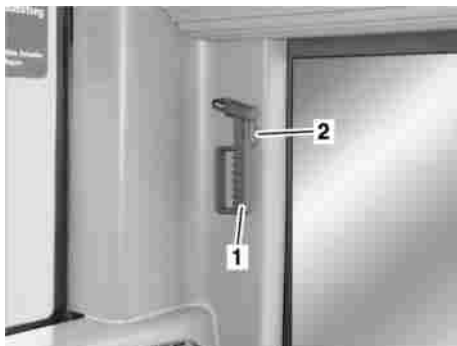

M86_00-0047-01

- ▶ Release emergency hammer (1) (lead seal) and remove it from bracket (2).

The emergency hammer is ready for operation.

Windscreen washer fluid reservoir installation location



M86_00-0343-01

- ▶ Open the front flap (to open the front flap, hold it by the handle recesses with both hands and pull).

**Note:**

Windscreen antifreeze order no.:
A 001 986 45 71 11

The windscreen washer fluid reservoir is located near the headlamp on the right-hand side.

Rotary light switch	102
Left steering column switch: light and signal functions	103
Left steering column switch: wiper and wash functions	103
Steering column switch for retarder and cruise control (option)	104
Ignition switch	107
Parking brake	108
Master safety switch (emergency-off switch)	109
Overview of indicator lamps	110
Screen: description	111
Operating displays/driving mode/bus stop mode	112
Continuation: bus stop mode	122
Malfunction displays: description	124
Malfunction displays: red warning level - description	125
Malfunction displays: red warning level - overview	126
Malfunction displays: yellow warning level A - description	128
Malfunction displays: yellow warning level A - overview	130

Table of contents

Malfunction displays: yellow warning level B - description	132
Malfunction displays: yellow warning level B - overview	134
Malfunction displays: warning level C - description	135
Malfunction displays: warning level C - overview	136
Calling up/selecting/permanently displaying operating displays	137
Selecting the language on the screen	138
Calling up and interpreting the fuel consumption indicator (option)	140
Vehicle manoeuvrability when the air suspension is depressurised	142
Lowering/raising the bus on the entry side	143
Raising the bus above normal level	145
Activating/deactivating the pull-away aid	147
Manual centring of the trailing axle	148
Activating/deactivating the automatic steering limiter for the trailing axle (bus stop function)	149
Guide wheel loss detection	151
Applying the parking brake	152
Releasing the parking brake	153

Emergency braking in the event of failure of both brake circuits	154
Activating/deactivating the bus stop brake	155
Drive-off lock	156
Important notes on the steering system	157
Adjusting the steering wheel	158
Turning the steering wheel when the bus is stationary	159
Opening/closing the driver's window	159
Switching the mirror and window heating on and off	160
Switching the windscreen heating (option) on/off	161

Rotary light switch

Rotary light switch

combines the following functions:

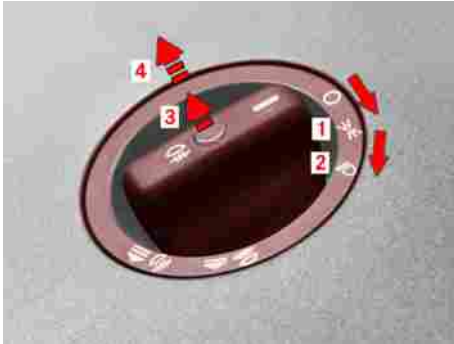

M54_00-0068-01

- 0 Switched off
- 1 Side lamps
- 2 Headlamps Dipped-beam headlamps/main-beam headlamps (depending on the steering column switch position) with the ignition switch in position 2 (drive position)



Note:

In countries where traffic drives on the opposite side of the road to that in which the vehicle is registered, there is a risk of dazzling other users with asymmetric dipped-beam headlamps. Observe the country-specific legal requirements when driving in these countries (mask headlamps if necessary).

- 3 Front foglamps (pull switch, first position). In addition to the side lamps, dipped-beam headlamps or main-beam headlamps when the ignition switch is switched on
- 4 Rear foglamp (pull switch, second position). In addition to the front foglamps. The indicator lamp in the rotary light switch lights up. When a trailer or skibox is connected, the rear foglamp on the towing vehicle is disabled and only the rear foglamp connected via the trailer socket is enabled.

Left steering column switch: light and signal functions

Left steering column switch: light and signal functions



M54_00-1326-71

- 1 Horn: Press button.
- 2 Indicate left and right with automatic reset: Push the switch stalk beyond the pressure point until it clicks into position.
- 3 Lane change: Push the switch stalk to the pressure point, hold it there and release it - the switch stalk returns to the centre position.

- 4 Headlamp flasher: Pull the switch stalk towards the steering wheel as far as the pressure point.
- 5 Main-beam and dipped-beam headlamps: Switch stalk in basic position = dipped-beam headlamps / pull the switch stalk towards the steering wheel beyond the pressure point = main-beam headlamps.

Left steering column switch: wiper and wash functions



M54_00-1327-71

- 6 Windscreen wipers: Turn the sleeve on the switch stalk: speed 0 = off, speed INT = intermittent, speed I = normal, speed II = rapid.



Note:

The roof hatches close automatically when the windscreen wipers are switched on.

Steering column switch for retarder and cruise control (option)

- 7 Wipe and wash: Press the sleeve on the steering column switch towards the steering column: With windscreen wipers switched off = wind-screen wipe and wash.

Steering column switch for retarder and cruise control (option)

Drive cruise control

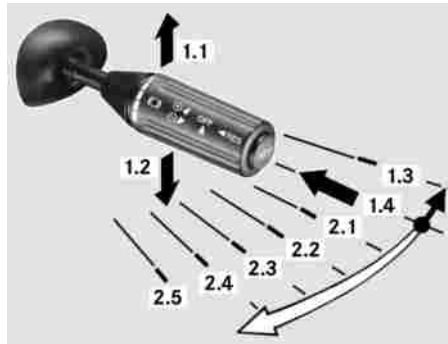

M54_00-0976-01

Activating drive cruise control: Precondition: bus speed must be greater than 10 mph (15 km/h). The service brakes and continuous brakes must not be activated.

1.1 Tap briefly (< 0.5 seconds) = current speed is set and shown on the display screen. Tap briefly again (< 0.5 seconds) = set speed is increased by 0.3 mph (0.5 km/h). Press and hold (> 0.5 seconds) = bus speed increased until switch released. When the combination switch is released, the current speed is set as the new value.

1.2 Tap briefly (< 0.5 seconds) = current speed is set and shown on the display screen, or resumption of last stored speed. Tap briefly again (< 0.5 seconds) = set speed is reduced by 0.3 mph (0.5 km/h). Press and hold (> 0.5 seconds) = bus speed reduced until switch released. When the combination switch is released, the current speed is set as the new value.

Steering column switch for retarder and cruise control (option)

1.3 Cruise control is switched off and the last stored speed remains stored in the control unit.

**Note:**

The drive cruise control is automatically deactivated as soon as the service brakes or continuous brakes are operated or the neutral button is pressed.

**Danger.**

Do not use cruise control on a slippery road surface - there is a risk of skidding. Only use cruise control if the road and traffic conditions permit a constant speed to be maintained.

**Note:**

It may not be possible to maintain a constant speed on steep uphill or downhill gradients.

Continuous braking

Activating continuous braking:

2.1 to 2.5 Retarder stage 1 to 5 active

**Danger.**

Do not activate the continuous brake (retarder) on a slippery road surface. The wheels could lock - risk of skidding.

**Danger.**

If the accelerator pedal is operated while the continuous brakes are active, the continuous brakes are deactivated and braking output is reduced to zero.

**Caution:**

Always move the combination switch through each of the available stages to achieve the required braking torque (do not move it directly to the required position). It is only permitted to move the combination switch directly to the required position in an emergency. However, it is acceptable to skip several stages at once if you are reducing the braking torque. To achieve an optimum braking torque, the engine should be turning within its upper speed range so that the temperature of the coolant does not increase excessively.

Steering column switch for retarder and cruise control (option)

Brake cruise control

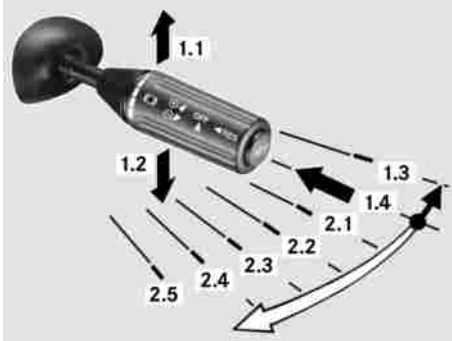

M54_00-0976-01

The retarder keeps the bus constant at a set speed within the maximum braking torque. Activating the brake cruise control: Precondition: retarder stage 1 to 5 (position 2.1 to 2.5) activated. Accelerator pedal and brake pedal not depressed.

1.1 Tap briefly (< 0.5 seconds) = current speed is set and shown on the display screen. Tap briefly again (< 0.5 seconds) = set speed is increased by 0.3 mph (0.5 km/h). Press and hold (> 0.5 seconds) = set speed increased until switch released. When the combination switch is released, the current speed is set as the new value.

1.2 Tap briefly (< 0.5 seconds) = current speed is set and shown on the display screen. Tap briefly again (< 0.5 seconds) = set speed is reduced by 0.3 mph (0.5 km/h). Press and hold (> 0.5 seconds) = set speed reduced until switch released. When the combination switch is released, the current speed is set as the new value.

Combined cruise control

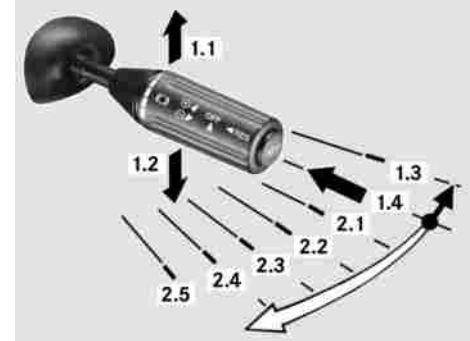

M54_00-0976-01

To activate combined cruise control: set drive cruise control and press in button 1.4 on the combination switch at the same time: the current speed is set (e.g. 88 km/h) and shown on the display screen and brake cruise control is automatically set to a value which is 4 km/h higher (e.g. 92 km/h) at the same time. Cruise control automatically switches between the modes of operation depending on requirements. The display on the display screen changes to one value or the other depending on

the mode of operation. Alternatively: set brake cruise control and push knob 1.4 in on the combination switch at the same time: the current speed is set (e.g. 62 mph (100 km/h)) and shown on the display screen and drive cruise control is automatically set to a value which is 2.5 mph (4 km/h) lower (e.g. 59.5 mph (96 km/h)) at the same time. Cruise control automatically switches between the modes of operation depending on requirements. The display on the display screen changes to one value or the other depending on the mode of operation.

Engine speed increase

Precondition: bus stationary, engine running.

1.1 The engine speed can be increased up to a maximum of 750 rpm.

1.3 Engine speed increase off, normal idling speed

Ignition switch



Danger.

Never lock the steering when the bus is moving. If you leave the bus, even for a short time, always remove the key so that the bus cannot be started by children or other unauthorised persons.

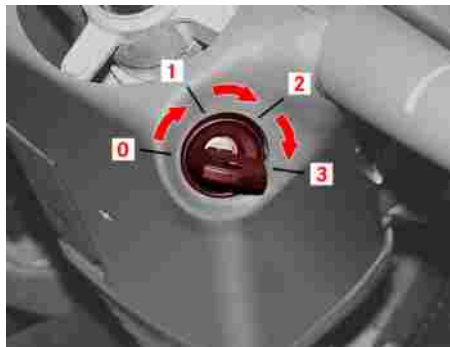

M54_00-0083-01

- 0 Rest position: Insert or remove the key in this position; the side lamps can be switched on.

- 1 Steering unlocked: All consumer units can be switched on.
- 2 Drive position
- 3 Starting position

Parking brake

Parking brake

Parking brake valve



Caution:

The parking brake spring actuators require a release pressure of 5.8 to 6.4 bar. At low reservoir pressures, there is a risk that the brake may not be fully released, that the friction pads may make slight contact while the bus is in motion and that the brake may be subjected to unnecessarily high thermal loads. When the parking brake is released, the relevant icon on the screen must go out. If the compressed-air system for the parking brake is damaged, it is possible to release the parking brake using the emergency release device.



Caution:

Only apply the parking brake when the bus is stationary.



Danger.

Always apply the parking brake before you leave the driver's area.



Danger.

Check that the hand lever is fully locked in place.



Danger.

ABS is inoperative when the parking brake is applied.



M42_00-0657-71

▷ For notes on safety and operation, refer to the “Driver's area controls” section of the Operating Instructions.

Master safety switch (emergency-off switch)

Master safety switch (emergency-off switch)

When master safety switch (17) is operated, the engine is switched off if running and the power supply to the vehicle electrical system is interrupted. The hazard warning lamps remain functional. The emergency-off switch is operated by opening the cover and pulling out the yellow knob.



Danger.

Risk of accident. The emergency-off switch should not be operated except in an emergency and only with the bus stationary - never while the bus is in motion. Operating the emergency-off switch causes the engine to switch off automatically. The power steering would consequently be disabled if the bus were in motion. Additional effort would then be required in order to steer. Furthermore, the power supply to all important electrical consumers (e.g. bus lighting, ABS, electronic transmission shift system, etc.) would be interrupted. The roadworthiness of the bus is at risk.



Note:

Additional functions may be available, depending on the national variant.



Note:

In Finland, Greece, Spain and Italy, the hazard warning lamps and interior lighting are switched on automatically. The central locking is enabled (ECE-R 36).



Note:

In France, the hazard warning lamps are enabled.



Note:

In Norway, the hazard warning lamps, interior lighting, auxiliary heating and horn are ready for operation.



Note:

In Poland, the hazard warning lamps are switched on automatically.



Note:

In Austria, operating the emergency-off switch switches off the engine and interrupts the supply of power to the entire electrical system.

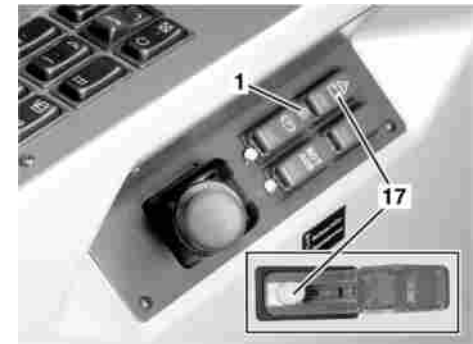

M54_00-0260-01

Overview of indicator lamps

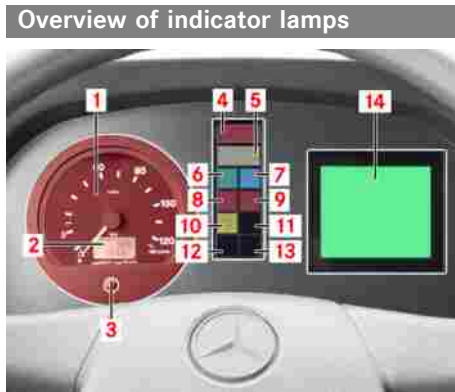

M68_00-0203-71



Danger.

Risk of accident. Red warning level malfunctions (4) indicate that the operating safety or roadworthiness of the bus is at risk. The driving and braking characteristics of the bus may change. The bus must be stopped immediately (traffic conditions permitting) and an EvoBus Service Partner must be notified.

4 Red warning lamp

5 Yellow warning lamp

6 Turn signals/hazard warning lamps

7 Main-beam headlamps/headlamp flasher

8 Brake system malfunction

9 Hazard warning lamps

10 Not assigned, assigned in accordance with customer requirements

11 Not assigned, assigned in accordance with customer requirements

12 Ramp

13 Engine malfunction indication lamp (MIL)



Note:

MIL (= malfunction indicator lamp)

Screen: description



M68_00-0203-71

Screen (14) is a status indicator for displaying operating and malfunction information. To provide the driver with information in an organised manner, the operating information is divided into three display types: 1.) Operating displays, 2.) Displays in driving mode, 3.) Displays in bus stop mode. For malfunction information, a distinction is made between major and minor malfunctions. Malfunction information is subdivided into four warning levels: 1.) Red warning level, 2.) Yellow warning level A, 3.) Yellow warning level B, 4.) Warning level C.

Screen (14) can also be used to display on-board diagnostics information. Screen (14) is activated whenever the following functions are switched on: electrical system, door opened from outside, exterior lighting, interior lighting, hazard warning lamps, radio call.

i Note:

The messages for the operating information and malfunction information are displayed in the language selected

i Note:

After the electrical system has been switched on, each of the operating displays is displayed automatically in succession.

i Note:

If the exterior lighting is switched on, screen (14) shows the display in inverse video (highlighted). If a malfunction occurs, this malfunction is displayed only if the key is in the drive position in the ignition starter switch.

i Note:

Also displayed is information from the computer-controlled operation management system (option).

Screen sequence

Operating displays/driving mode/bus stop mode

Operating displays/driving mode/bus stop mode

To provide the driver with information in an organised manner, the operating information is divided into three display types: 1.) Operating displays, 2.) Displays in driving mode, 3.) Displays in bus stop mode.

1.) Operating displays.



M54_00-1139-01

After the electrical system has been switched on, each of the operating displays is displayed on the screen once in succession. Once all operating displays have been shown, the only way to view

them again is to press pushbutton (3) on the instrument panel.



Danger.

Risk of accident. Calling up information while the vehicle is in motion would distract your attention from the road and traffic. This could result in an accident with serious or fatal injuries. For this reason, do not call up information unless the bus is stationary and the parking brake is applied.



Note:

This display mode remains active for approximately 5 seconds. Then, if the parking brake is not applied or if the bus stop brake or drive-off lock is not active, the display mode switches to "Driving mode". If the parking brake is applied or if the bus stop brake or drive-off lock is active, the display mode switches to "Bus stop mode".

Splitscreen

The screen is split horizontally into two differently sized areas. The upper area occupies 3/4 of the screen, the lower area 1/4. Both areas can be operated independently using pushbutton (3).



Note:

The splitting of the screen is virtual, i.e. there is no visible partition between the two areas. The split is only evident when the upper or lower area is operated independently of the other using pushbutton (3).

Brake pressure, supply pressure and (engine) oil pressure

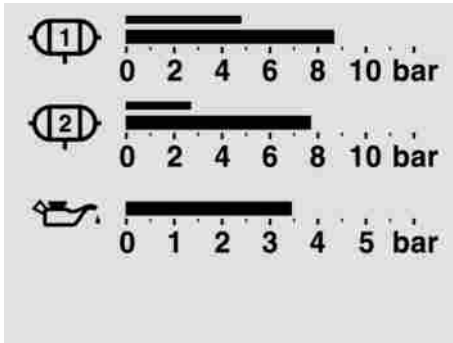

M54_00-1131-01

The brake pressure and supply pressure for brake circuits one (1) and two (2) are each represented by a bar ranging from 0 to a maximum of 12 bar. The thicker bar represents the supply pressure, the thinner bar the brake pressure of the relevant brake circuit. The current oil pressure of between 0 and 5 bar is displayed below the display for brake circuits one and two.

Fuel level, AdBlue level and (engine) oil level

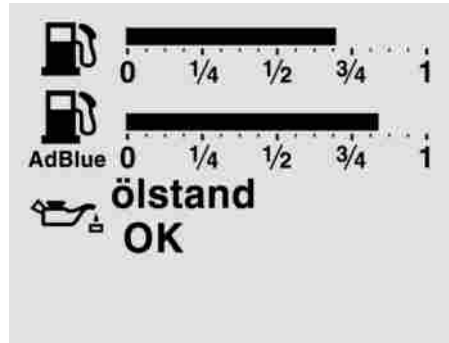

M54_00-1132-01

The fuel level is represented by a bar ranging from 0 (empty) to 1 (full). The same applies to the AdBlue level. The “Oil level OK” message indicates that the oil level is correct.

i **Note:**

Whenever the oil level is correct, no other oil level information is available to view.

i **Note:**

If the oil level is not correct, see the following displays.

Oil level too low

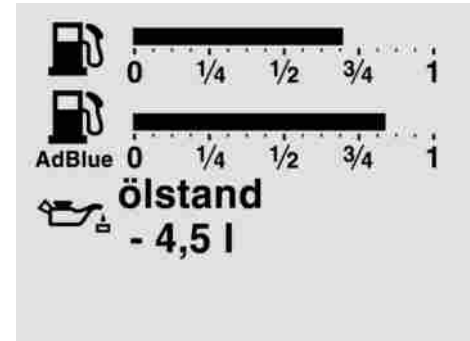

M54_00-1134-01

An insufficient oil level is indicated by the “Oil level” message and the top-up

Operating displays/driving mode/bus stop mode

amount required in litres (4.5 litres in the example).



Note:

This display is only available if a yellow warning level malfunction or the “Message available” symbol (spanner symbol) has previously been displayed.



Caution:

There is a risk of engine damage if the oil level is too low. For this reason, correct the oil level at the earliest opportunity.

Oil level too high

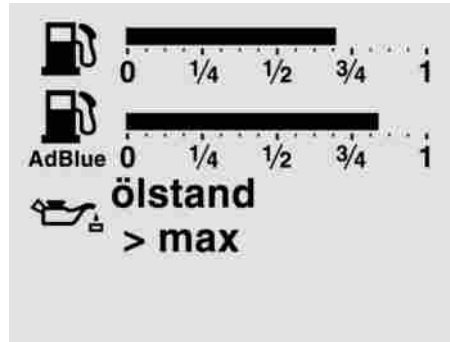

M54_00-1135-01

The oil level is too high if the “Oil level > max” message is displayed.



Note:

This indication display is available to view only if a yellow warning level malfunction has previously been displayed.



Note:

There is a risk of engine damage if the oil level is too high. For this reason, correct the oil level at the earliest opportunity.

Oil level cannot be measured

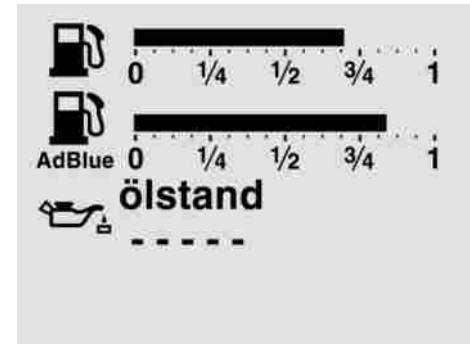

M54_00-1136-01

If the “Oil level -----” message is displayed, this means that the system is unable to measure the oil level.

Coolant temperature, transmission oil temperature and engine oil temperature

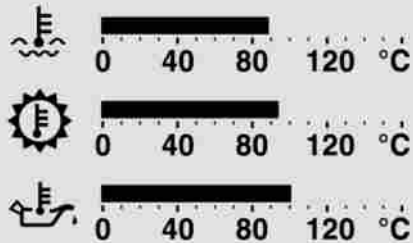

M54_00-1133-01

The indication display at the top represents the current coolant temperature as a bar gauge ranging from 0 °C to a maximum of 160 °C. The indication display in the middle represents the current transmission oil temperature, the indication display at the bottom the current engine oil temperature.

2.) Driving mode displays



M54_00-0173-01

This display mode is active when the vehicle is in motion. It notifies the driver of important system information and indicates when a system is active or when a system is temporarily limited in its operation or scope of functions but no malfunction is present.



Note:

Also displayed is information from the computer-controlled operation management system (option).

Driving mode displays - overview

Message available



Caution:

“Message available” symbol (spanner symbol) on the screen indicates that it is possible to call up a message (malfunction, maintenance due) from a system.

Operating displays/driving mode/bus stop mode



Caution:

If the “Message available” symbol is shown permanently on the screen, consult or visit the relevant workshop.

Transmission oil too hot



Displayed if the oil in the retarder is too hot.



Caution:

To protect the retarder from damage caused by overheating during continuous operation, the braking effect of the retarder is reduced automatically as a function of the operating temperature. Adapt your driving style accordingly, particularly on long downhill gradients.

Retarder active (permanent display)



Displayed whenever the brake pedal is depressed or the retarder is operated manually by the driver.

Automatic transmission neutral indicator



Displayed whenever the “N” pushbutton in the switch panel is pressed down and the transmission is in neutral.

Acceleration skid control deactivated (flashing)



Displayed when acceleration skid control is deactivated.



Danger.

Risk of accident from spinning drive wheels. The bus may skid if the drive wheels start to spin.

Acceleration skid control activated (permanent display)



Displayed if the drive wheels on one side start to spin and acceleration skid control actively intervenes.



Danger.

Risk of accident. Acceleration skid control does not relieve the driver of the responsibility for adopting a driving style which takes traffic and road conditions into account.

Parking brake active (permanent display)



Displayed whenever the parking brake lever is applied.



Danger.

Danger. Do not apply the parking brake unless the bus is stationary. Always apply the parking brake before you disembark. On uphill and downhill gradients, you must also chock the wheels and turn the steering towards the kerb.



Note:

Danger. Check the hand lever for full engagement. To do so, attempt to press the hand lever in the “release” direction without pulling the release ring out of the detent position. The lever must not move.

Bus stop brake active (permanent display)



Displayed when the bus stop brake is active.



Danger.

Risk of accident. Apply the parking brake before you leave the driver's area. It is prohibited to use the bus stop brake as a means of parking the bus. Apply the parking brake at bus stops on steep uphill or downhill gradients that exceed 15 %.



Danger.

Risk of accident. Do not apply the bus stop brake unless the bus is stationary.

Stop request (flashing)



Displayed whenever a passenger presses one of the “STOP” pushbuttons in the passenger compartment.

Ramp request (flashing)



Displayed whenever a passenger presses one of the “Ramp request” pushbuttons in the passenger compartment or on the outside of the bus.

Operating displays/driving mode/bus stop mode

Pushchair (flashing)



Displayed whenever a passenger presses one of the “Pushchair” pushbuttons in the passenger compartment or on the outside of the bus.



Note:

The door system holds the door open whenever a “Pushchair” pushbutton is pressed.

Bus raised/lowered (permanent display)



Displayed if the bus has been raised or lowered beyond the normal level.



Note:

For notes on safety and operation, refer to the “Driver's area controls” section of the Operating Instructions.

Anti-jackknifing protection active (permanent display)



Displayed whenever anti-jackknifing protection is active during forward travel.



Note:

For notes on safety and operation, refer to the “Operation” section of the Operating Instructions.

Anti-jackknifing protection active (A) (permanent display), bus stop brake active (B) (permanent display)

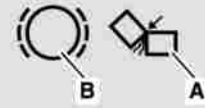

M54_00-0241-01

Displayed whenever anti-jackknifing protection is active during reverse travel.



Note:

For notes on safety and operation, refer to the “Operation” section of the Operating Instructions.

Centralised lubrication (option) active (permanent display)



Displayed whenever the centralised lubrication system initiates (carries out) a lubrication process.

Auxiliary heating active (permanent display)



Displayed whenever the auxiliary heating system is switched on.

Heating for driver's window and exterior mirror active (permanent display)



Displayed whenever the heating for the driver's window and exterior mirror heating is switched on.

i Note:

The heating for the driver's window and exterior mirror remains active for only approximately 12 minutes.

Windscreen heating (option) active (permanent display)



Displayed whenever the windscreen heating is active.



Note:

The windscreen heating remains active for only approximately 12 minutes.

Air-conditioning system active (permanent display)



Displayed as soon as the refrigerant compressor is running.

Roof hatches open (permanent display)



Displayed whenever the roof hatches are open.

Operating displays/driving mode/bus stop mode

Fuel level low (permanent display)



Note:

Display for fuel level in reserve range.

activated with the drive-off lock still active. The bus symbol is always displayed for this display mode.



Note:

Also displayed is information from the computer-controlled operation management system (option).

3.) Bus stop mode displays

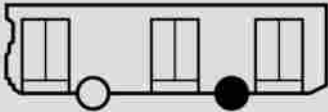

Markt Bahnhof
12:35 H 23122 +5

M54_00-0174-01

This display mode is activated whenever the bus is stationary and the parking brake is applied or the bus stop brake

Driver's area controls

Continuation: bus stop mode

Continuation: bus stop mode

A

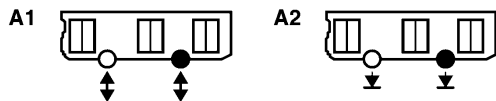

B

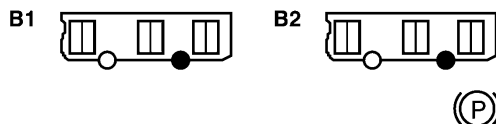

C

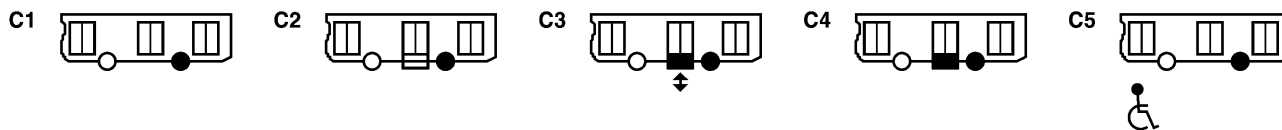

D



E

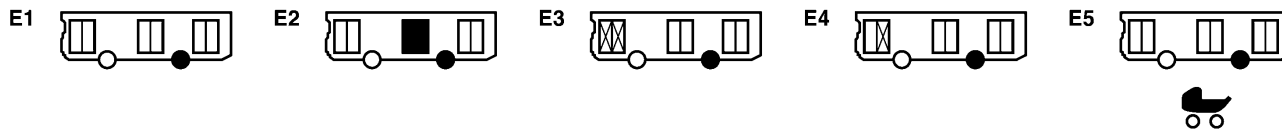

A	Bus symbols for the lowering system	D	Bus symbols for the lift	E5	<i>Permanent bus display with pushchair symbol = hold door open requested or activated (pushchair switch)</i>
A1	<i>Arrows flashing = lowering active</i>	D1	<i>Permanent bus display = lift retracted (out-of-use position), not enabled</i>		
A2	<i>Arrows permanently displayed = lowering complete</i>	D2	<i>Lift flashing = lift enabled</i>		
B	Bus symbols for the brake system	D3	<i>Arrow flashing = lift in operation</i>		
B1	<i>Permanent wheel display = drive-off lock or bus stop brake active</i>	D4	<i>Permanent lift display = lift lowered</i>		
B2	<i>Permanent wheel display with parking brake symbol = parking brake applied</i>	D4	<i>Lift flashing = lift malfunction</i>		
C	Bus symbols for the ramp	E	Bus symbols for the doors		
C1	<i>Permanent bus display = ramp retracted, not enabled</i>	E1	<i>Permanent bus display = doors closed, not enabled</i>		
C2	<i>Ramp flashing = ramp enabled</i>	E1	<i>Door flashing = door closed, enabled</i>		
C3	<i>Arrow flashing = ramp in use</i>	E2	<i>Permanent door display = door open</i>		
C4	<i>Permanent ramp display = ramp extended</i>	E2	<i>Door flashing = door malfunction</i>		
C4	<i>Ramp flashing = ramp malfunction</i>	E3	<i>Permanent door display = door disabled</i>		
C5	<i>Permanent bus display with wheelchair symbol = ramp requested</i>	E4	<i>Permanent door leaf display = door leaf disabled</i>		

Malfunction displays: description

Malfunction displays: description

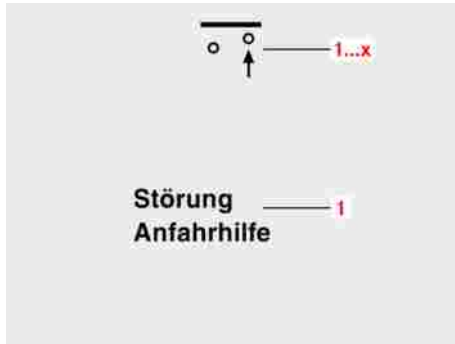

M54_30-0099-71

A distinction is made between major and minor malfunctions. Malfunctions that have occurred are indicated on the screen by a malfunction display. Malfunction displays always consist of a symbol (1...x) and a malfunction text (1). These are displayed one under the other on the screen.

 **Note:**
The malfunction texts are displayed in the language selected.

Major malfunctions



M68_00-0203-71

Major malfunctions are displayed immediately in conjunction with red warning lamp (4) and remain active until the malfunctions themselves have been rectified. A warning signal also sounds. It is not possible to clear the malfunction display or switch to a different display mode.



Risk of accident. Red warning level malfunctions (4) indicate that the operating safety or roadworthiness of the bus is at risk. The driving and braking characteristics of the bus may change. The bus must be stopped immediately (traffic conditions permitting) and an EvoBus Service Partner must be notified.

Minor malfunctions

Minor malfunctions are subdivided into warning levels A, B and C. Minor malfunctions from warning levels A and B are displayed immediately as they occur in conjunction with yellow warning lamp (5). No warning signal sounds.

Malfunction displays: red warning level - description



M68_00-0203-71

A malfunction indicated by red warning lamp (4) is immediately accompanied by a malfunction display on the screen. Malfunction displays with red warning lamp (4) remain active on the screen until the malfunctions have been rectified. The malfunction display cannot be cleared if the red warning lamp is lit.

**Danger.**

Risk of accident. Red warning level malfunctions (4) indicate that the operating safety or roadworthiness of the bus is at risk. The driving and braking characteristics of the bus may change. The bus must be stopped immediately (traffic conditions permitting) and an EvoBus Service Partner must be notified.

**Danger.**

Risk of accident. If the rear car begins to swing from side to side, the bus must be stabilised by braking. If a malfunction occurs in the anti-jackknifing protection system (red warning lamp in conjunction with the “Anti-jackknifing protection” symbol), it is permissible to drive the bus as far as the nearest workshop but only in exceptional cases, in favourable weather conditions (non-skid road surface) and at a speed of no more than 12 mph (20 km/h). In all other cases the bus must be towed.

Malfunction displays: red warning level - overview

Malfunction displays: red warning level - overview



Malfunction displays: red warning level - overview



Note:

Depending on the type of malfunction, the same symbol may be displayed with a different malfunction text, see symbol (10) for example.

1	Brake pressure signal malfunction	10	Engine oil replenishment failure. Oil level too low, check oil level. (Only in buses with automatic oil replenishment)	23	Anti-jackknifing system malfunction (articulated buses only)
2	Supply pressure too low (brake circuit 1)	11	Coolant too hot	24	Auxiliary steering malfunction (buses with trailing axle only)
3	Supply pressure too low (brake circuit 2)	12	Hydrostatic fan drive malfunction	25	Engine compartment fire
4	ABS/ASR failure	13	Door system malfunction		
5	Drive control failure	14	Emergency valve operated		
6	Engine control failure	15	Level control failure		
7	Transmission malfunction	16	Entry aid malfunction		
8	Transmission oil too hot	17	Fuel level too low		
9	No oil pressure	18	No battery charge		
10	Oil level too low, check oil level	19	FPS module 1 malfunction		
		20	Headroom clearance warning		
		21	Engine compartment fire message		
		22	Roof hatch emergency release		



Note:

There may be up to 8 FPS modules in the bus. The number (1...8) referring to the module concerned is shown after the malfunction text

Malfunction displays: yellow warning level A - description

Malfunction displays: yellow warning level A - description



M68_00-0203-71

Malfunction displays of warning level A are displayed immediately in conjunction with yellow warning lamp (5).



Caution:

In the event of a yellow warning level malfunction, it is permissible to drive on carefully but the bus should be checked by an EvoBus Service Partner at the earliest opportunity.

Screen sequence



M54_00-1139-01

Malfunction displays of warning level A have to be acknowledged by the driver pressing pushbutton (3) (upper section).

Screen sequence

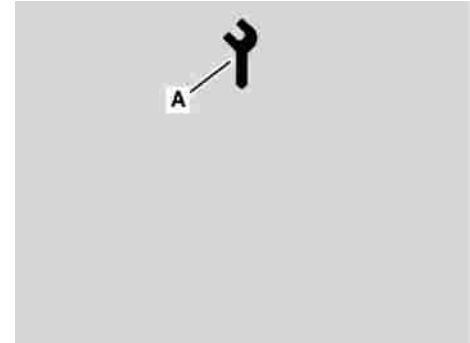

M54_00-0631-01

Once the malfunction is acknowledged, yellow warning lamp (5) goes out, and "Message available" symbol (A) is shown on the screen



Note:

"Message available" symbol (A) on the screen indicates that it is possible to call up a message (malfunction, maintenance due) from a system.

Malfunction displays: yellow warning level A - description



Caution:

In the event of a yellow warning level malfunction, it is permissible to drive on carefully but the bus should be checked by an EvoBus Service Partner at the earliest opportunity.

Malfunction displays: yellow warning level A - overview

Malfunction displays: yellow warning level A - overview



Malfunction displays: yellow warning level A - overview



Note:

Depending on the type of malfunction, the same symbol may be displayed with a different malfunction text, see symbol (15) for example.

1 ABS/ASR failure



Note:

If the "Bus stop brake malfunction" message is also displayed on the screen, the bus stop brake is no longer operational.

1 ASR trailing axle malfunction (buses with four axles only)



Danger.

With increased caution, it is possible to continue to drive the bus (route can be completed). The bus must then be inspected as soon as possible in the workshop. Braking performance may be affected. Traction could be limited on slippery surfaces.

2 Parking brake malfunction

3 Retarder malfunction

4 Bus stop brake malfunction

5 Undervoltage

6 No battery charge

7 No battery charge

8 No battery charge

9 Fuel level too low

10 Supply pressure too low

11 Level control malfunction

12 Entry aid malfunction

13 Anti-jackknifing system malfunction (articulated buses only)

14 Auxiliary steering malfunction (buses with trailing axle only)

15 Oil level too low, check oil level

15 Engine oil replenishment failure. Oil level too low, check oil level. (Only in buses with automatic oil replenishment)

15 Oil level too high, check oil level



Caution:

There is a risk of engine damage if the oil level is too low or too high. For this reason, correct the oil level at the earliest opportunity.



Note:

Observe the "Display mode: bus stop mode - overview" section.

16 Air drier malfunction

17 AdBlue level too low

18 Fire detection system failure

Malfunction displays: yellow warning level B - description

- 19 Fire extinguishing system failure
- 20 Engine torque reduction
- 21 Track guidance malfunction

Malfunction displays: yellow warning level B - description

Malfunction displays of warning level B are displayed on screen (14) for approximately 10 seconds in conjunction with yellow warning lamp (5). Once the malfunction display and yellow warning lamp (5) have gone out, the “Message available” symbol is shown on the screen.

Symbol Description



The “Message available” symbol on the screen indicates that it is possible to call up a message (malfunction, maintenance due) from a system.

Malfunction displays: yellow warning level B - overview

Malfunction displays: yellow warning level B - overview

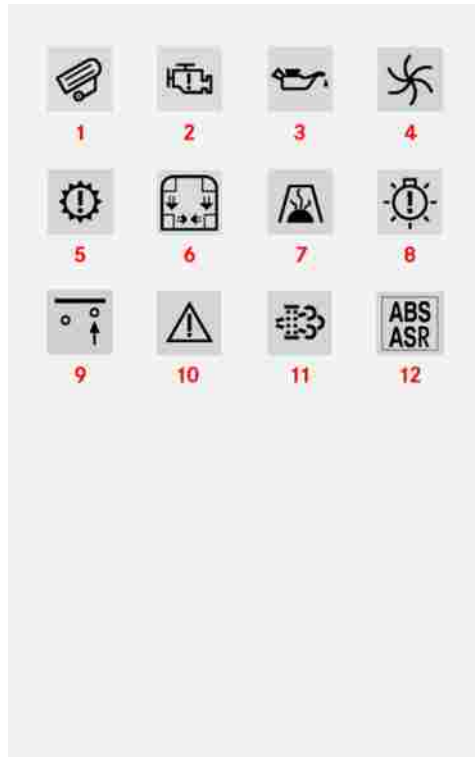

Malfunction displays: warning level C - description



Note:

Depending on the type of malfunction, the same symbol may be displayed with a different malfunction text, see symbol (8) for example.

1	Drive control failure	8	Exterior lighting malfunction, front foglamps
2	Engine control failure	8	Exterior lighting malfunction, brake lamps
3	No oil pressure	8	Exterior lighting malfunction, auxiliary brake lamps
4	Hydrostatic fan drive malfunction	8	Exterior lighting malfunction, reversing lamps
5	Transmission malfunction	8	Exterior lighting malfunction, tail lamps
6	Heating/ventilation malfunction	8	Exterior lighting malfunction, side lamps
7	Auxiliary heating malfunction	8	Exterior lighting malfunction, licence plate lamps
8	Exterior lighting malfunction	8	Front turn signals malfunction
8	Exterior lighting malfunction, dipped-beam headlamps	8	Rear turn signals malfunction
8	Exterior lighting malfunction, main-beam headlamps	8	Additional turn signal lamps malfunction
8	Exterior lighting malfunction, rear foglamp	9	Pull-away aid malfunction (buses with trailing axle only)
		10	Gas system malfunction (compressed natural gas CNG vehicles only)
		11	Diesel particulate filter (DPF)
		12	ABS/ASR malfunction

Malfunction displays: warning level C - description

No malfunction display is shown on the screen. Yellow warning lamp (5) remains off. Only the "Message available" symbol is shown on the screen.

Symbol Description



The "Message available" symbol on the screen indicates that it is possible to call up a message (malfunction, maintenance due) from a system.

Malfunction displays: warning level C - overview

Malfunction displays: warning level C - overview

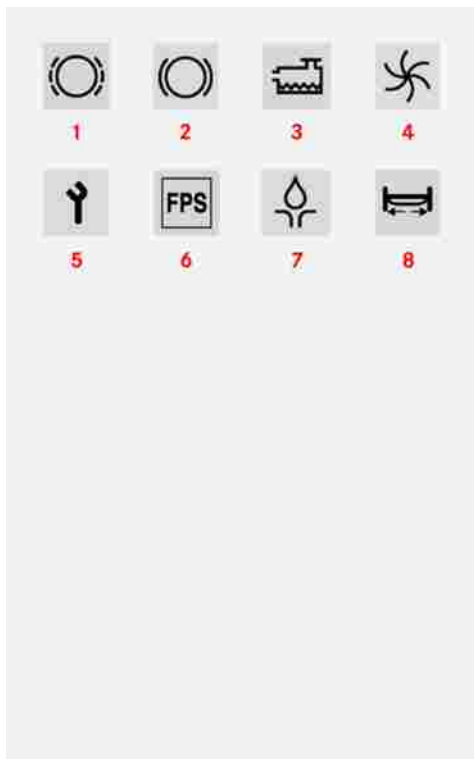

Calling up/selecting/permanently displaying operating displays

- 1 Brake pad thickness too low
- 2 Brake pressure signal malfunction
- 3 Coolant level too low
- 4 Hydrostatic fan drive, check oil level
- 5 Read the fault memory
- 6 FPS module 1 malfunction
- 7 Lubrication system malfunction

**Note:**

Depending on the type of malfunction, the same symbol may be displayed with a different malfunction text, see symbol (8) for example.

**Note:**

There may be up to 8 FPS modules in the bus. The number (1...8) referring to the module concerned is shown after the malfunction text.

- 8 Auxiliary steering malfunction, oil level low (buses with trailing axle only)
- 8 Auxiliary steering malfunction, replace filter (buses with trailing axle only)

Calling up/selecting/permanently displaying operating displays

**Note:**

Precondition: electrical system on.

**Danger.**

Risk of accident. Calling up information while the vehicle is in motion would distract your attention from the road and traffic. This could result in an accident with serious or fatal injuries. For this reason, do not call up information unless the bus is stationary and the parking brake is applied.

Selecting the language on the screen



M54_00-1139-01

- ▶ To call up operating displays: press the upper section of pushbutton (3).

The first display shown on the screen is the “Brake pressure, supply pressure and (engine) oil pressure” operating display.

After approximately 5 seconds, the display automatically switches from “Operating displays” mode to “Driving displays” mode.



Note:

If the parking brake is applied, the displays do not scroll on automatically. The operating display called up previously is shown and remains on the screen.

- ▶ To view a particular operating display: press the upper section of pushbutton (3) repeatedly until the desired operating display is shown.

The operating displays can be called up in the following sequence: “Brake pressure, supply pressure and (engine) oil pressure”, “Fuel level, Ad-Blue level and (engine) oil level”, “Coolant temperature, transmission oil temperature and engine oil temperature”.

- ▶ To hold a particular operating display on the screen: press pushbutton (3) again and hold it for more than 3 seconds.

A signal sounds.

The operating display called up remains on the screen.

Selecting the language on the screen



Note:

Precondition: bus stationary, parking brake applied.

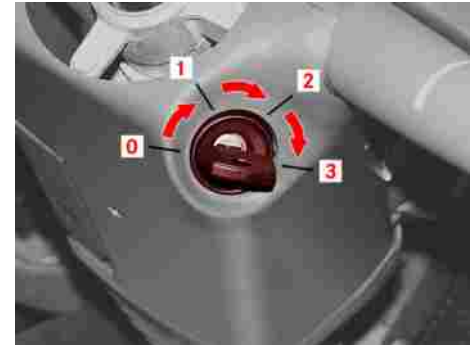

M54_00-0083-01

- ▶ Ignition starter switch position (0).

Selecting the language on the screen

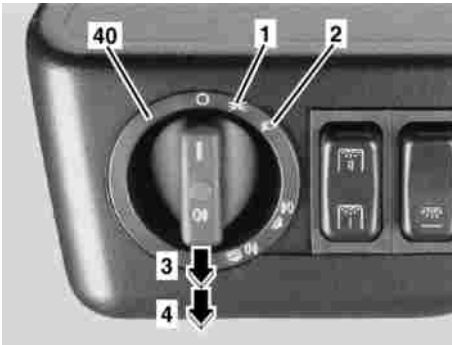

M54_00-0191-01

- ▶ Switch on side lamps (1).



M54_00-1325-71

- ▶ Slide sleeve (7) on the steering column switch (wipe/wash) towards the steering column for longer than 5 seconds.

The language control menu (country codes) appears on the screen.

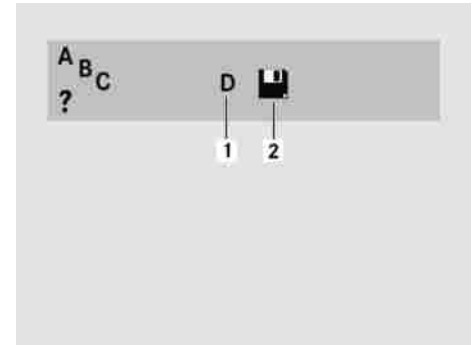

M00_00-0321-01

- ▶ It is now possible to find the desired language by pressing the steering column switch down (to scroll down) or up (to scroll up).
- ▶ To save the displayed language (1), slide and hold the sleeve on the steering column switch again. Disk icon (2) flashes while saving is in progress.

Calling up and interpreting the fuel consumption indicator (option)

- ▶ Saving is complete when flashing disk icon (2) lights up permanently. Releasing the sleeve exits the selection menu.



Note:

It is possible to cancel the process at any time by switching off the side lamps.

Calling up and interpreting the fuel consumption indicator (option)



M54_00-1139-01

- ▶ To call up the fuel consumption indicator:



Note:

Press the lower section of pushbutton (3) repeatedly until the fuel consumption indicator appears in the lower section of the display.



Note:

The fuel consumption indicator remains displayed until another display is manually selected or other information briefly appears.

Calling up and interpreting the fuel consumption indicator (option)

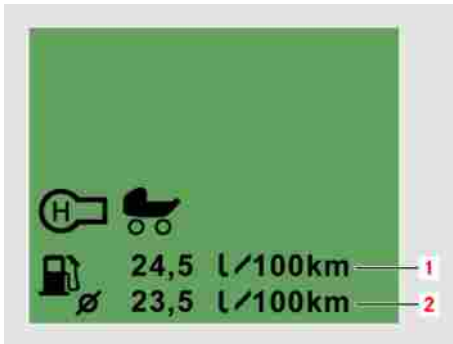

M54_00-1256-71

- Interpreting the display while the bus is in motion:



Note:

(1) = current consumption in l/100 km



Note:

(2) = average consumption in l/100 km (total)

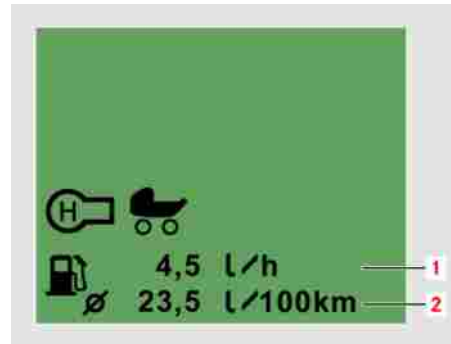

M54_00-1257-71

- Fuel consumption indicator while the bus is stationary:



Note:

The display of current consumption is converted from l/100 km to l/h automatically while the bus is stationary ($v < 1.5$ km/h).



Note:

(1) = current consumption in l/h



Note:

(2) = average consumption in l/100 km (total)



M54_00-1258-71

- To reset the average consumption (total), press RESET pushbutton (1) for longer than 2 seconds with a long, thin object (e.g. a pen).

Vehicle manoeuvrability when the air suspension is depressurised



Note:

The fuel consumption indicator must have already been selected and be visible on the display screen.



Note:

It is possible to reset the average consumption (total) even while the bus is in motion.

Vehicle manoeuvrability when the air suspension is depressurised

The front chassis and driven axle guide have been designed so that the bus is guaranteed to be manoeuvrable even when the suspension air bags are depressurised.

In this condition, the whole weight of the bus lays on the stop buffers built into the front chassis and rear axle. They are not used when the suspension operates normally and only prevent the bus hitting the axle when compression is extreme. The stop buffers have not been designed to be operated under continuous loading and cannot be considered a replacement for the normal suspension under any circumstances. Additionally, the bodywork can be damaged (cracks etc.).



Danger.

Although the vehicle remains manoeuvrable when the suspension is depressurised, it must only be driven at walking pace to the nearest lay-by or EvoBus Service Partner. The body must always be secured at the correct points by using jacks and floor stands whenever work is carried out on the pneumatic suspension system as the vehicle body can sink relatively quickly if there is an air loss.

Lowering/raising the bus on the entry side

i Note:

Precondition: electrical system on, bus stationary, doors closed, operating pressure > 6.5 bar, red indicator lamp off, lowering/raising with key switch on, level control operational.

⚠ Danger.

Risk of accident. Only operate the lowering system with the bus stationary and for no purpose other than as an entry aid.

⚠ Danger.

Risk of accident. Ensure that no objects or persons are present under the bus, particularly their feet.



M54_00-0209-01

- ▶ Press and hold the lower section of pushbutton (26) until the bus is lowered.

The bus lowers on the entry side.

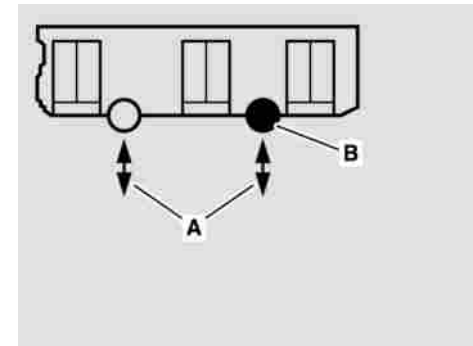

M54_00-0230-01

While the bus is being lowered, the screen shows: “Bus lowering” (A), “Drive-off lock active” (B).

Lowering/raising the bus on the entry side

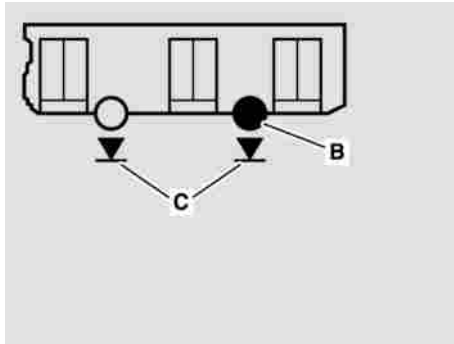

M54_00-0231-01

After the lowering process, the screen shows: "Lowering complete" (C), "Drive-off lock active" (B).

Note:

After the bus has been lowered, it is possible to open the doors and extend the ramp.

- ▶ Briefly press the upper section of pushbutton (26).

The bus is raised back to the normal level.

Note:

Doors must be closed.

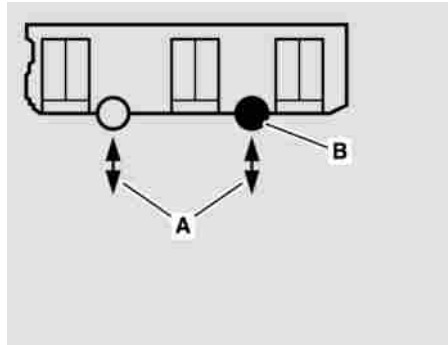

M54_00-0230-01

While the bus is being raised, the screen shows: "Bus rising" (A), "Drive-off lock active" (B).

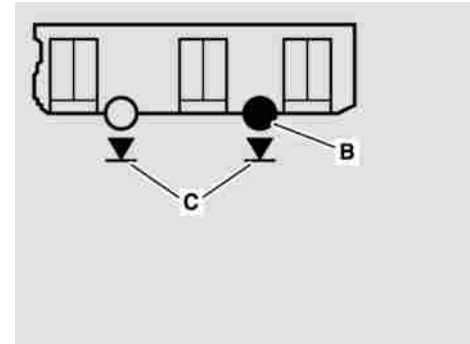

M54_00-0231-01

After the raising process, the screen shows: "Raising complete" (C), "Drive-off lock active" (B).

Note:

The bus is raised automatically if the doors are closed or pushbutton (26) is released during the lowering process.

Raising the bus above normal level

Raising the bus above normal level

i **Note:**

Precondition: electrical system on, bus stationary, doors closed, operating pressure > 6.5 bar, red indicator lamp off, lowering/raising with key switch on, level control operational.

⚠ **Danger.**

Risk of accident. Do not exceed the maximum permissible vehicle height when driving with the bus raised above normal level. In Germany, the maximum permissible vehicle height is limited to 4 metres. Observe national specifications in all other countries (even for cross-border operation).

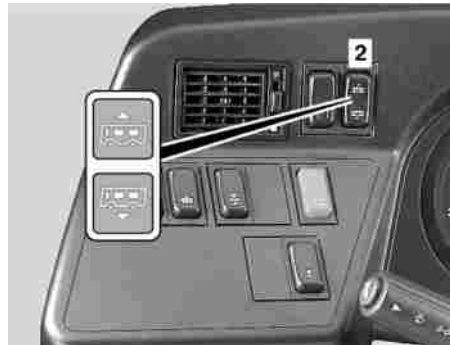

M54_00-0188-01

- ▶ Press the upper section of pushbutton (2) in bus stop mode.

The bus is raised for as long as the pushbutton is pressed.

i **Note:**

Release the pushbutton when the bus has reached the required height.

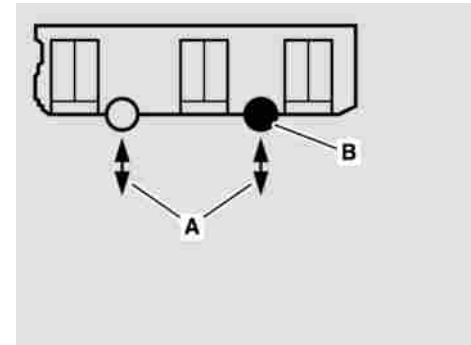

M54_00-0230-01

The following is shown on the screen: "Raised level active" (A).

i **Note:**

This function is displayed if the Bus stop mode display is active.

- ▶ Briefly press the upper section of pushbutton (2) in driving mode.

The bus is raised for as long as the pushbutton is pressed.

Raising the bus above normal level



M54_00-0355-01

The buzzer sounds briefly. Yellow indicator lamp (14) lights up briefly.

The following is shown on the screen: "Bus raised" (B).

Note:

This function is displayed if the Driving mode display is active.

Note:

Release the pushbutton when the bus has reached the required height.

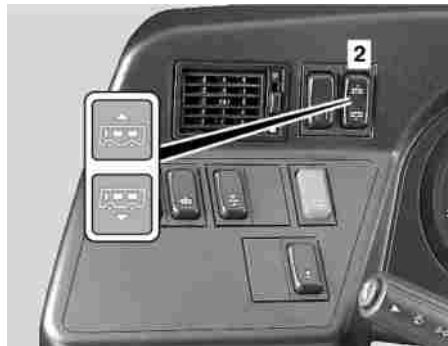

M54_00-0188-01

- ▶ Briefly press the lower section of pushbutton (2).

The bus is lowered to the normal level.

The function indicator on the screen goes out.

Note:

Lowering is cancelled if pushbutton (2) is pressed up during the lowering process.

Activating/deactivating the pull-away aid

- ▶ Electrical system on
- ▶ Bus travelling less than 12 mph (20 km/h)



Note:

The pull-away aid has the effect of relieving the load on the trailing axle. The load on the driven axle is increased. This reduces the tendency of the drive wheels to spin on a slippery road surface.



M54_00-1316-71

- ▶ Press the lower section of pushbutton (B4).

The pull-away aid is activated.

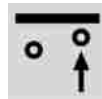

The following appears on the screen: "Pull-away aid active".

- ▶ Press the lower section of pushbutton (B4) again.

The pull-away aid is deactivated.

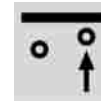

The "Pull-away aid active" indication display on the screen goes out.



Note:

The pull-away aid is deactivated automatically as soon as the bus travels faster than 20 mph (30 km/h). The "Pull-away aid active" indication display on the screen goes out.

Manual centring of the trailing axle

Manual centring of the trailing axle

- ▶ Electrical system on
- ▶ Bus travelling less than 12 mph (20 km/h)

i **Note:**

If the trailing axle is centred, the rear end of the bus will swing out less and the turning circle (w to w) will increase.

i **Note:**

The trailing axle is always centred automatically whenever the bus is travelling faster than 20 mph (35 km/h).

i **Note:**

Without manual centring, the trailing axle is steered fully in proportion to the front axle at speeds of up to 12 mph (20 km/h).

i **Note:**

Without manual centring, the steering angle of the trailing axle is continuously returned to 0° at a speed of between 12 mph (20 km/h) and 20 mph (35 km/h).



M54_00-1315-71

- ▶ Press and hold the upper section of pushbutton (B1) until indicator lamp (22) lights up.

The trailing axle is centred parallel to the driven axle.

i **Note:**

Manual centring is cancelled as soon as the bus travels faster than 25 mph (40 km/h). To restore manual centring at speeds of below 20 mph (35 km/h), it is necessary to press switch (B1) again.



M54_00-0516-01

- ▶ Press the upper section of pushbutton (B1) until indicator lamp (22) goes out.

Manual centring below 20 mph (35 km/h) is cancelled.

Activating/deactivating the automatic steering limiter for the trailing axle (bus stop function)



M54_00-0516-01

Indicator lamp (22) goes out.

i **Note:**

Indicator lamp (22) flashes if the control unit does not detect a defined axle position (there is no malfunction).

i **Note:**

Indicator lamp (22) stops flashing when the control unit detects a defined axle position again.

Activating/deactivating the automatic steering limiter for the trailing axle (bus stop function)

i **Note:**

The steering limiter prevents the steering at the trailing axle from being turned further on pulling out of a bus stop than when the bus was pulled into the bus stop. The rear of the bus will swing out less.

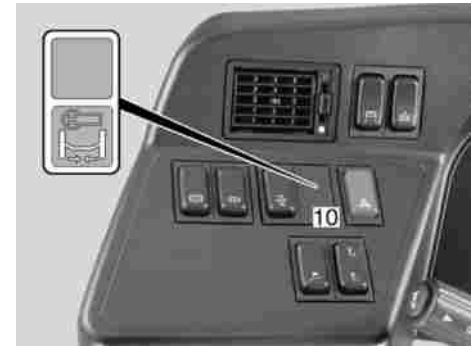

M54_00-0512-01

- ▶ Press the lower section of pushbutton (10).
The automatic steering limiter is operational.
- ▶ The steering is turned.
The previous steering angle is stored.
- ▶ A door is opened and closed again.
The steering limiter is activated.

Activating/deactivating the automatic steering limiter for the trailing axle (bus stop function)



M54_00-0516-01

Indicator lamp (22) lights up.



Note:

The automatic steering limiter is not activated until the door has closed.



Note:

The automatic steering limiter is activated even if the enabled door is subsequently disabled using pushbutton (35).

- ▶ The steering is turned.
The trailing axle is turned no further than the previously stored steering angle.
- ▶ The bus reaches a speed of over 10 mph (15 km/h).
The automatic steering limiter is deactivated.



M54_00-0516-01

Indicator lamp (22) goes out.



Note:

The steering wheel must be in the straight-ahead position.



Note:

The automatic steering limiter becomes ready for operation again as soon as the speed of the bus falls below 10 mph (15 km/h).

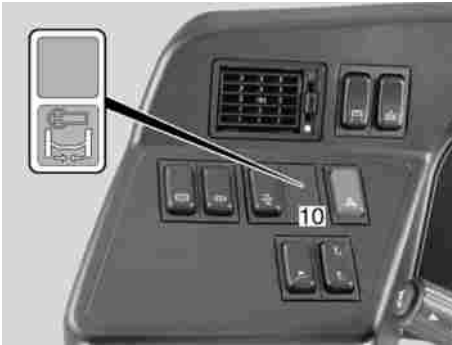

M54_00-0512-01

- ▶ Press the upper section of pushbutton (10).
The automatic steering limiter is deactivated.

Guide wheel loss detection

- ▶ The driver is notified by the following alerts if the guide wheel bracket at the front axle is overloaded:

A buzzer sounds.

A yellow warning level A malfunction display is displayed.



An icon lights up and the following text appears on the screen: "Lane guidance malfunction".



Caution:

Have malfunctions rectified as soon as possible at a qualified specialist workshop which has the necessary specialist knowledge and tools.



Note:

As guided buses are wider than 2.55 m, these vehicles are subject to the approval conditions of the country in which they are operated.



Note:

If the bus is operated outside Germany, the requirements and regulations that apply in the country concerned must be observed.

Applying the parking brake

Applying the parking brake



Note:

Precondition: minimum operating pressure of 5.5 bar.



Danger.

Risk of accident. There is a fault in the parking brake circuit if the "Brake system malfunction" indicator lamp lights up while there is sufficient operating pressure. Have the brake system checked at an EvoBus Service Partner.

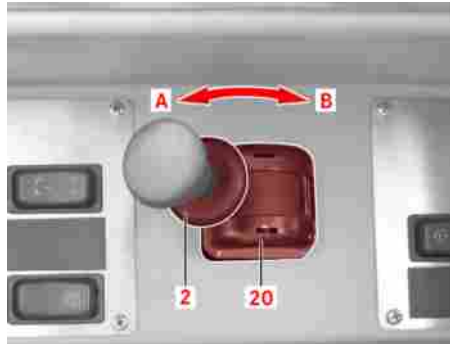

M42_00-0657-71

- ▶ Pull the parking brake lever back (A) and engage it.

The parking brake is applied (air venting noise can be heard).



Danger.

Do not apply the parking brake unless the bus is stationary. Always apply the parking brake before you leave the driver's area. On uphill and downhill gradients, you must also chock the wheels and turn the steering towards the kerb.



Danger.

Check the hand lever for full engagement. To do so, attempt to press the hand lever in the "release" direction (B) without pulling release ring (2) out of the detent position. The lever must not move.

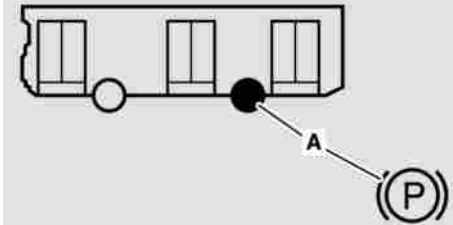

M54_00-0232-01

The following appears on the screen: "Parking brake applied" (A).

Releasing the parking brake



M42_00-0657-71

- Pull locking ring (2) up and push parking brake lever (20) forwards (B).

The parking brake is released (air charging noise can be heard).

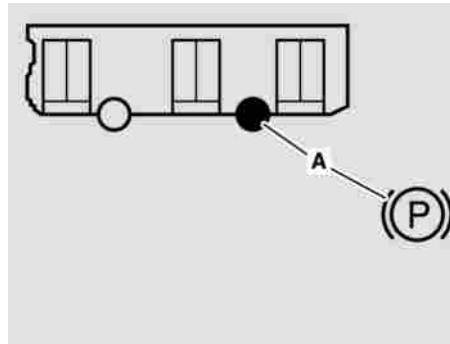

M54_00-0232-01

The “Parking brake applied” indication display (A) on the screen goes out.

**Note:**

A continuous warning tone sounds if the electrical system is switched off with the parking brake released.

**Note:**

To guarantee a faultless release of the parking brake, the supply pressure must be at least 5.5 bar. If the parking brake indicator lamp goes out despite there being sufficient supply pressure, there is a fault in the spring actuator or the emergency release circuit. Have the brake system checked by an EvoBus Service Partner immediately.

Emergency braking in the event of failure of both brake circuits

Emergency braking in the event of failure of both brake circuits



Danger.

A failure in brake circuits 1 and 2 will jeopardise the operating safety and road-worthiness of the bus. Stop the vehicle immediately (traffic conditions permitting). Have the brake system checked by an EvoBus Service Partner immediately.



Note:

In the event of a failure in brake circuits 1 and 2, it is possible to initiate emergency braking using the parking brake lever.

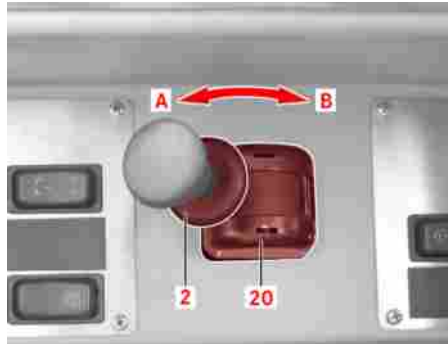

M42_00-0657-71

- ▶ Pull release ring (2). Slowly pull the hand lever towards the Applied position (A) and hold it in the desired position, otherwise it will automatically return to the Released position (B).



Danger.

When performing emergency braking using the parking brake, make sure that the parking brake lever does not engage in the parking position. Release ring (2) must be held in the applied position.

The bus is braked at the rear wheels only.



Note:

It is possible to pull the parking brake lever back to any position before the limit position. This enables you to prevent the rear wheels from locking and to control the amount of braking force applied.



Danger.

Risk of accident. The anti-lock braking system (ABS) is not operational when the parking brake is applied. You should pay particular attention when driving on slippery roads, since the rear wheels could lock.

Activating/deactivating the bus stop brake

i **Note:**

Precondition: bus stationary, electrical system on.

⚠ **Danger.**

If the bus stop brake is not used as intended, the vehicle could roll away. This could result in an accident with serious or fatal injuries. For this reason, always apply the parking brake before you start/stop the engine or leave the driver's area. Do not under any circumstances use the bus stop brake to park the bus or to secure it against rolling away. Apply the parking brake whenever you come to a stop on a steep uphill or downhill gradient of more than 15 % or pull into a bus stop on a steep uphill or downhill gradient of more than 15 %. Do not activate the bus stop brake unless the vehicle is stationary.



M54_00-0210-01

- ▶ Press the lower section of switch (25).

The bus stop brake is active.

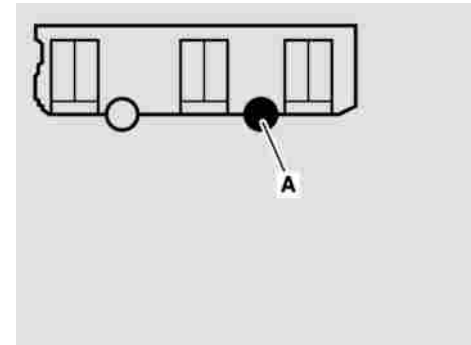

M54_00-0237-01

The following appears on the screen: "Bus stop brake active" (A).

- ▶ Press the upper section of switch (25); depress the accelerator pedal.

The bus stop brake is released.

i **Note:**

The drive-off lock is not released until the accelerator pedal is depressed.

Drive-off lock

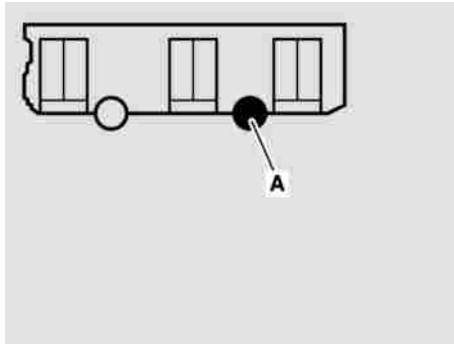

M54_00-0237-01

The “Bus stop brake active” indication display (A) on the screen goes out.

Drive-off lock



Note:

Precondition: bus stationary, electrical system on.



Danger.

If the drive-off lock is not used as intended, the vehicle could roll away. This could result in an accident with serious or fatal injuries. For this reason, always apply the parking brake before you start/stop the engine or leave the driver's area. Do not, under any circumstances, use the drive-off lock to park the bus or to secure the bus against rolling away. Apply the parking brake whenever you come to a stop on a steep uphill or downhill gradient of more than 15 % or pull into a bus stop on a steep uphill or downhill gradient of more than 15 %.

- ▶ Open the door.

The following appears on the screen: “Drive-off lock active” (A). Addition-

ally, the status indicator for the action is also displayed.

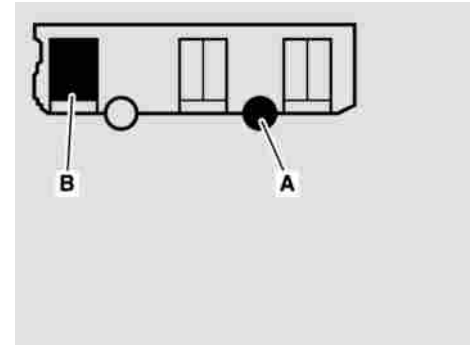

M54_00-0235-01

In the example: “Door open” (B).



Note:

The drive-off lock is also activated if the following functions are active: “Lower bus”, “Operate ramp”, “Operate lift”.

- ▶ Close the door, depress the accelerator pedal.

Important notes on the steering system

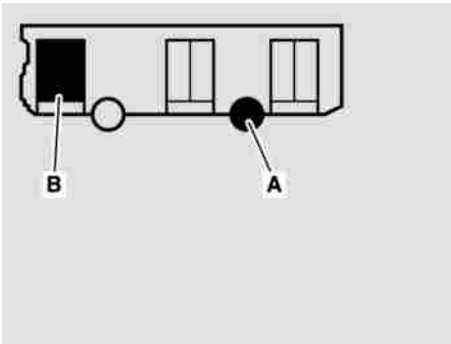

M54_00-0235-01

The “Drive-off lock active” indication display (A) on the screen goes out.

**Note:**

The drive-off lock is not released until the accelerator pedal is depressed.

Important notes on the steering system

The dimensions of the steering system and the mechanical steering transmission ratio were designed such that, in the event of a malfunction in the hydraulic power steering system, the effort required to turn the steering wheel would not exceed a specific value deemed by legislators to be the maximum reasonable force.

For vehicles above 12 t this force is 450 N (400 N for vehicles between 3.5 t and 12 t) applied to the steering wheel circumference when turning the vehicle from straight-ahead driving into a circle with a 20 m radius at a road speed of approximately 10 km/h. No more than 6 seconds must pass from the start of turning to reaching the 20 m radius.

The driver must be aware that, in the event of a sudden failure in the power steering (e.g. due to a pump drive malfunction), the bus will remain steerable but considerably more effort will be required.

Since there is an extremely low probability of this situation occurring - but if it does occur, it often does so completely unexpectedly - the driver could wrongly assume that the steering system has been blocked. In fact, the driver merely has to use the level of effort required to continue steering.

This important information is intended to clarify the scenario described and prevent the driver from possibly misjudging the situation.

**Danger.**

In the event of a power steering failure, the bus becomes very difficult to steer. Have the malfunction rectified immediately at an EvoBus Service Partner.

Adjusting the steering wheel

Adjusting the steering wheel



Note:

Precondition: bus stationary, electrical system on, driver's seat adjusted and parking brake applied (bus stop brake applied, one door open, bus lowered)



Danger.

Adjust the steering wheel before the start of a journey and never when the vehicle is in motion. There is an increased risk of accident if you release the steering wheel during stops in traffic. The steering wheel would instantly engage in its current position the moment the vehicle pulled away again.

- ▶ Press the lower section of the switch.
The steering column lock is released.



M46_00-0029-01

- ▶ Raise, push or tilt the steering wheel.

Both the height and angle of the steering wheel can be adjusted to a position most suitable for the driver's height and arm length.



Note:

The instrument panel adjusts along with the steering wheel.

- ▶ Press the upper section of the switch.

The steering wheel and instrument panel are locked in their current position.

Turning the steering wheel when the bus is stationary

Turning the steering wheel when the bus is stationary

- Observe the instructions and information.

**Note:**

To prevent damage to the steering column, the following points must be observed when turning the steering wheel with the bus stationary, without hydraulic support (engine switched off) and without a turntable under the front wheels (tyres in direct contact with the ground):

- Release the steering wheel adjuster and push the steering wheel fully down. Lock the steering wheel adjuster in place. Turn the steering wheel using both hands placed apart at an angle of between 90° and 180°.

**Caution:**

Never have more than one person turn the steering wheel. Do not pull the steering wheel on one side only.

**Note:**

We ask the workshop in particular to note this.

Opening/closing the driver's window

**Note:**

Precondition: electrical system on.

**Danger.**

Risk of injury. Monitor closing of the driver's window to ensure that nobody can become trapped.

Switching the mirror and window heating on and off



M54_00-1320-71

- ▶ Press the lower section of pushbutton (C1).
The window is opened.
- ▶ Press the upper section of pushbutton (C1).
The window is closed.



Note:

The window stops in its current position if power windows pushbutton (C1) is released when opening or closing the driver's window.

Switching the mirror and window heating on and off



Note:

Precondition: engine running.



Note:

The window and the exterior mirror heating is limited to approximately 12 minutes.

Switching the windscreen heating (option) on/off



M54_00-1317-71

- ▶ Press the lower section of pushbutton (7).

The indicator lamp in pushbutton (7) lights up.

The heating is active.



The following is shown on the screen:
“Window/exterior mirror heated”.

- ▶ Press the upper section of pushbutton (7).

The indicator lamp in switch (7) goes out.

The heating is switched off.



The “Window/exterior mirror heated” indication display on the screen goes out.

Switching the windscreen heating (option) on/off



Note:

Precondition: electrical system on, engine running.



Note:

Windscreen heating is limited to approximately 12 minutes.

Switching the windscreen heating (option) on/off



M54_00-1328-71

- ▶ Press the lower section of pushbutton (7).

The indicator lamp in pushbutton (7) lights up.

Windscreen heating is active.



The following is shown on the screen:
“Windscreen heated”.

- ▶ Press the upper section of pushbutton (7).

The indicator lamp in pushbutton (7) goes out.



The “Windscreen heated” indication display on the screen goes out.

Windscreen heating is switched off.

Important notes on the driver's seat	164
Grammer MSG 90.5 driver's seat control elements	166
Using the driver's seat belt	168

Important notes on the driver's seat

Important notes on the driver's seat

It is essential that the following instructions be observed:



Danger.

In the interests of road safety, the driver's seat must not be adjusted when the bus is in motion.



Note:

The following descriptions provide a brief overview of the control elements. The manufacturer's operating instructions provided must be observed in all cases.







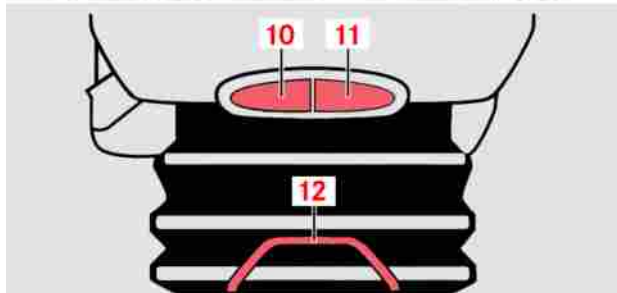
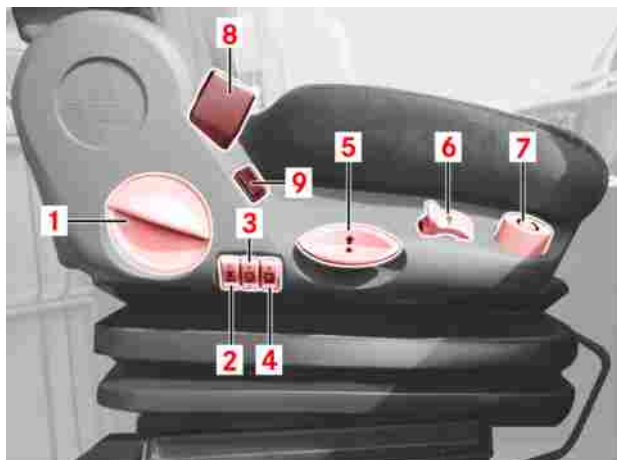

Driver's seat/passenger seats

Grammer MSG 90.5 driver's seat control elements

Grammer MSG 90.5 driver's seat control elements



Grammer MSG 90.5 driver's seat control elements

- | | | | |
|---|---|----|--|
| 1 | Backrest adjustment | 9 | Seat heating switch (option) |
| | <div style="border: 1px solid #ccc; padding: 5px; background-color: #f9f9f9;">  Note:
Relieve load on backrest, pull lever upwards, move into required position, release lever. </div> | 10 | Seat cushion angle adjustment |
| | | | <div style="border: 1px solid #ccc; padding: 5px; background-color: #f9f9f9;">  Note:
Relieve load on backrest, pull button upwards: the seat angle can now be adjusted. </div> |
| 2 | Lateral support adjustment | 5 | Height adjustment |
| | <div style="border: 1px solid #ccc; padding: 5px; background-color: #f9f9f9;">  Note:
Individually adjustable lateral support by two compressed-air chambers. (+) chamber fills up or (-) chamber empties. </div> | | <div style="border: 1px solid #ccc; padding: 5px; background-color: #f9f9f9;">  Note:
Pull lever up = upward adjustment. Push lever down = downward adjustment. </div> |
| | | 6 | Damper setting |
| | | | <div style="border: 1px solid #ccc; padding: 5px; background-color: #f9f9f9;">  Note:
The damper setting can be infinitely adjusted between soft and hard. </div> |
| 3 | Lumbar support (upper chamber) | 6 | Seat cushion depth adjustment |
| | <div style="border: 1px solid #ccc; padding: 5px; background-color: #f9f9f9;">  Note:
(+) chamber fills up or (-) chamber empties. </div> | | <div style="border: 1px solid #ccc; padding: 5px; background-color: #f9f9f9;">  Note:
Pull button upwards: the seat cushion can now be adjusted. </div> |
| | | 7 | Driver's seat fore-and-aft adjustment |
| | | | <div style="border: 1px solid #ccc; padding: 5px; background-color: #f9f9f9;">  Note:
Pull lever upwards: the seat can now be slid in the longitudinal direction. </div> |
| 4 | Lumbar support (lower chamber) | 7 | Swivel release mechanism |
| | | | <div style="border: 1px solid #ccc; padding: 5px; background-color: #f9f9f9;">  Note:
Press button downwards: the seat can now be turned (swivel range: 50° to the left, 90° to the right). </div> |
| | | 8 | Seat belt buckle |

Using the driver's seat belt

Using the driver's seat belt



Note:

The driver's seat fitted has an integrated belt system. The user instructions therefore only apply to belts that were installed in the manufacturing plant.



Note:

Section 21a of the German road traffic regulations (StVO) stipulates that the seat belt must be buckled while the vehicle is in motion. Observe the legal requirements in all countries concerned.

- ▶ Fastening the seat belt: pass the seat belt untwisted and tightly across your pelvis and shoulder and insert the tongue into the belt buckle until you hear it engage.



Danger.

The seat belt must not pass over your neck, be snagged or rub against sharp edges. It should fit as close to the body as possible. You should therefore avoid wearing bulky clothing. Do not route the seat belt over solid or fragile objects in pockets in your clothing. Frequently retighten the seat belt over your shoulder.

- ▶ Releasing the seat belt: press the red button in the belt buckle and assist the inertia reel by guiding the seat belt back.

Automatic transmission - general	170
Selector positions of the 3-pushbutton switch panel	171
Selector positions of the 6-pushbutton switch panel	173

Automatic transmission - general

Automatic transmission - general



Danger.

Risk of accident. The bus is free to move with the transmission in neutral “N” and the brakes released. Apply the parking brake and press pushbutton N whenever the bus is parked or work is to be carried out on the bus with the engine running. Do not shift down on a slippery road surface (risk of skidding). Press pushbutton N when there is a risk of sliding and skidding. For a brief stop, such as at a bus stop or traffic lights, keep the gearshift unit in its current position and bring the bus to a halt using the service brake or bus stop brake. Shift down in good time on long uphill or downhill gradients, especially when under a big load.



Note:

Changing gear with the automatic transmission: the engine can only be started when the transmission is switched to the neutral position N. The individual gears are changed automatically in response to the position of the switches, the road speed and the accelerator pedal position.



Note:

Driving away: apply the service brake. Select the gearshift position by pressing a pushbutton with the engine at idling speed (accelerator pedal not depressed). Do not release the brake until the bus begins to pull away. There is otherwise a risk of the bus pulling away too soon (bus creeps). On upwards slopes release the brake and simultaneously depress the accelerator pedal.



Note:

Accelerator pedal positions: little throttle for low acceleration and sooner upshifts. More throttle for high acceleration and later upshifts. Kickdown (depressing the accelerator pedal to the stop beyond the full throttle position) for maximum acceleration. The transmission shifts down to a lower gear if the road speed is below the maximum speed for the next gear down. The transmission shifts up when the engine is running at rated speed.

Selector positions of the 3-pushbutton switch panel

Selector positions of the 3-pushbutton switch panel

i Note:

Precondition: pushbutton “N” pressed, bus stationary, service brake applied, accelerator pedal released (engine speed < 900 rpm).

i Note:

Applies to the automatic transmissions: ZF Ecomat 6-speed transmission and Voith 4-speed automatic transmission.

i Note:

Each button lights up when pressed.



Caution:

If the pressed button begins to flash, this is a warning that there is a severe risk of transmission damage (limited system monitoring). In this event, it is permitted to drive on to the nearest workshop but only with the engine under partial load.



Caution:

Observe the towing guidelines if the transmission is damaged.

▷ For towing guidelines, refer to the “Operation” section of the Operating Instructions.



M54_00-0229-01

▶ Press switch “R”.

The automatic transmission shifts to reverse gear.



Danger.

Risk of accident. Do not shift into reverse gear unless the bus is stationary and the engine is running at idling speed.

Selector positions of the 3-pushbutton switch panel



Note:

It is necessary to press the “N” button first if button “D” is pressed after button “R” or if button “R” is pressed after button “D”.



Note:

During reverse travel, a warning tone will sound if this feature has been requested by the customer or stipulated by national regulations.



M54_00-0228-01

- ▶ Press switch “N”.

The automatic transmission shifts to neutral.

The bus is free to move if no brakes are applied. There is no power transmission from the engine to the driven axle.



M54_00-0227-01

- ▶ Press switch “D”.

Gears 1 to 4 (4-speed transmission) or 1 to 6 (6-speed transmission) are automatically selected in succession.



Note:

Drive position “D” provides ideal driving characteristics in almost all operating situations.

Selector positions of the 6-pushbutton switch panel

Selector positions of the 6-pushbutton switch panel

i Note:

Precondition: pushbutton “N” pressed, bus stationary, service brake applied, accelerator pedal released (engine speed < 900 rpm).

i Note:

Applies to the automatic transmissions: ZF Ecomat 6-speed transmission and Voith 4-speed automatic transmission.

i Note:

Each button lights up when pressed.



Caution:

If the pressed button begins to flash, this is a warning that there is a severe risk of transmission damage (limited system monitoring). In this event, it is permitted to drive on to the nearest workshop but only with the engine under partial load.



Caution:

Observe the towing guidelines if the transmission is damaged.

▷ For towing guidelines, refer to the “Operation” section of the Operating Instructions.



M54_00-0203-01

▶ Press switch “R”.

The automatic transmission shifts to reverse gear.



Danger.

Risk of accident. Do not shift into reverse gear unless the bus is stationary and the engine is running at idling speed.

Selector positions of the 6-pushbutton switch panel



Note:

It is necessary to press the “N” button first if button “1” or “D” is pressed after button “R” or if button “R” is pressed after button “1” or “D”.



Note:

During reverse travel, a warning tone will sound if this feature has been requested by the customer or stipulated by national regulations.



M54_00-0204-01

- ▶ Press switch “N”.

The automatic transmission shifts to neutral.

The bus is free to move if no brakes are applied. There is no power transmission from the engine to the driven axle.



M54_00-0205-01

- ▶ Press switch “D”.

Gears 1 to 4 (4-speed transmission) or 1 to 6 (6-speed transmission) are automatically selected in succession.



Note:

Drive position “D” provides ideal driving characteristics in almost all operating situations.

Selector positions of the 6-pushbutton switch panel



M54_00-0206-01

- ▶ Press switch 3.

The transmission shifts through gears 1 to 3 automatically.



Note:

For driving on slight to moderate uphill gradients to prevent transmission hunting between 3rd and 4th gear.

On a downhill gradient, this selector position makes full use of the engine braking effect up to the maximum permissible engine speed in 3rd gear.



M54_00-0207-01

- ▶ Press switch 2.

The transmission shifts between gears 1 and 2 automatically.



Note:

For driving on moderate uphill gradients to prevent transmission hunting between the 2nd and 3rd gear.

On a downhill gradient, this selector position makes full use of the engine braking effect up to the maximum permissible engine speed in 2nd gear.



M54_00-0208-01

- ▶ Press switch 1.

For driving on steep uphill gradients and for manoeuvring the bus at slow speeds.



Note:

Only 1st gear is selected.

On a downhill gradient, this selector position makes full use of the engine braking effect up to the maximum permissible engine speed in 1st gear.

Safety instructions for the air-conditioning system	179
Operating instructions for the air-conditioning system	179
Heating/ventilation/air-conditioning control panel - driver's area	180
Heating/ventilation/air-conditioning control panel - whole bus	182
Driver's area - setting the air distribution/demisting the windscreen	183
Driver's area - adjusting the temperature	184
Driver's area - adjusting the blower speed	185
Driver's area - cooling	186
Additional driver's area ventilation (option)	187
Switching air-recirculation mode on and off	187
Passenger compartment – switching automatic temperature regulation on and off - code HH2/HK1	188
Passenger compartment – switching automatic temperature regulation on and off	189
Switching the auxiliary heating on and off	190
Switching the reheat function on and off	192
Passenger-compartment temperature - changing the base value	193
Opening the roof hatches	196

Table of contents

Fans on/off	199
Switching fans on and off - code HH2/HK1	200
Auxiliary heating digital timer (option)	202
Auxiliary heating operation (option)	203

Safety instructions for the air-conditioning system

Air-conditioning systems that are operated with refrigerant R 134 a are labelled with appropriate stickers and/or plates on the compressor.

Never mix R 134 a refrigerant and the corresponding DEA Triton SE 55 refrigerator oil with other products.

It is forbidden to disregard the latest technological standards and allow refrigerant to escape into the environment when servicing or decommissioning air-conditioning systems.

Refrigerant and refrigerator oils must be disposed of separately, or recycled.

Maintenance work on air-conditioning systems as well as removal of refrigerants and oils may only be carried out by persons who have the relevant and necessary specialist knowledge, technical equipment and official approval (control of health and safety at work, local government, TÜV).

The operator must maintain a logbook auditing the consumption of refrigerant and refrigerator oils.



Danger.

On automatically controlled air-conditioning systems, the ventilation blowers can be started at any time by the condenser or evaporator units. Therefore turn the ignition switch to the OFF position when carrying out cleaning work. Do not reach into the fan blades or fan rollers. Avoid any contact with refrigerant as there is a risk of frostbite. Treat affected skin areas as for frostbite, and contact a doctor straight away. Carry out maintenance and repair tasks with the engine switched off whenever possible. Keep a safe distance from moving parts (e.g. belt drive) when the engine is running.

Operating instructions for the air-conditioning system



Note:

The driver's window should remain closed while the vehicle is in motion and the air-conditioning is operating to ensure faultless operation of the air-conditioning system.

Heating/ventilation/air-conditioning control panel - driver's area

Heating/ventilation/air-conditioning
control panel - driver's area

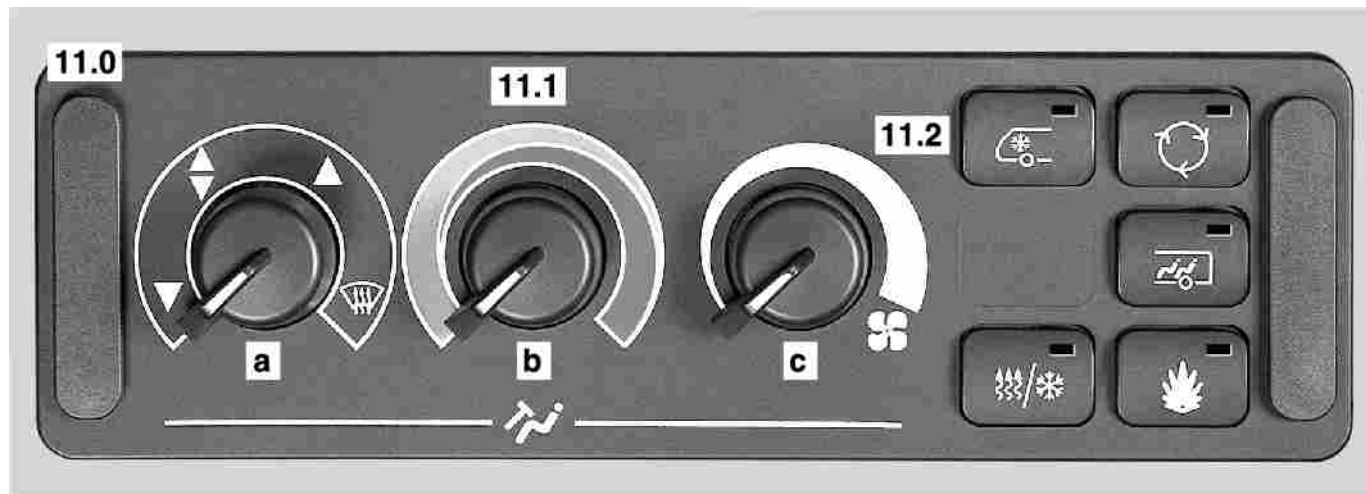

Heating/ventilation/air-conditioning control panel - driver's area

- A Air distribution
 - B Temperature control
 - C Blower output
- 11.2 Driver's area cooling

Heating/ventilation/air-conditioning control panel - whole bus

Heating/ventilation/air-conditioning
control panel - whole bus

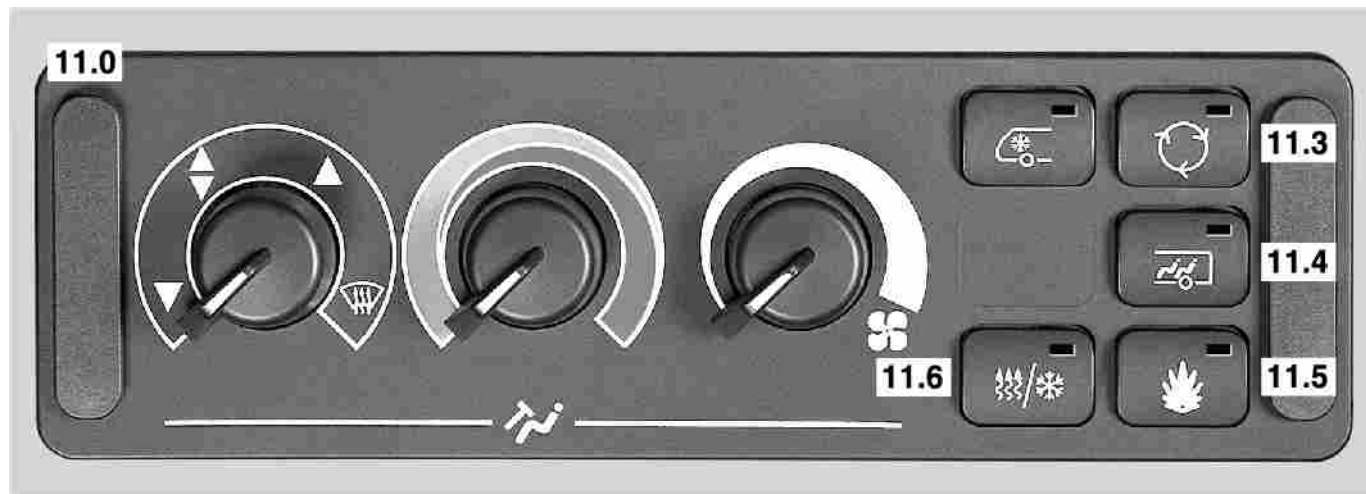

Driver's area - setting the air distribution/demisting the windscreen

- 11.3
 - 1. Air recirculation function
 - 2. To increase the base value for the passenger-compartment temperature
- 11.4
 - 1. Passenger-compartment temperature control on/off
 - 2. To call up the program for changing the base value
 - 3. To confirm the base value for the passenger-compartment temperature
- 11.5
 - 1. Auxiliary heating on/off
 - 2. To decrease the base value for the passenger-compartment temperature
- 11.6 : Reheat on/off

Driver's area - setting the air distribution/demisting the windscreen



Note:

Precondition: electrical system on.



M83_00-0132-01

- ▶ Turn switch (a) to position 1.

Air flows out: - in the footwell to the right-hand side of the steering column (adjustable), in the footwell on the left-hand side (non-adjustable), at the left-hand side windows, at the right-hand side of the

driver's cab, at the driver's platform and at the instrument panel.

- ▶ Turn switch (a) to position 2.

Air flows out: - in the footwell, at the left-hand side windows, at the right-hand side of the driver's cab, at the driver's platform, at the instrument panel and at the windscreen.



M83_00-0132-01

- ▶ Turn switch (a) to position 3.

Air flows out: at the windscreen and at the instrument panel

Driver's area - adjusting the temperature

- ▶ Turn switch (a) to position 4 (windscreen demisting).

Air flows out: at the windscreen (for demisting) and at the instrument panel



Note:

The blower runs at maximum output and cannot be regulated.



Note:

Air is permanently blown out the following air vents: instrument panel, front right footwell (adjustable), right-hand side of driver's cab.

Driver's area - adjusting the temperature



Note:

The target temperature for the driver's area is infinitely adjustable.

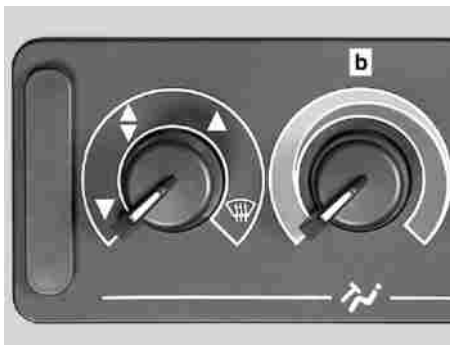

M83_00-0056-01

- ▶ Turn switch (b) clockwise into the red area.

The temperature in the driver's area is increased.

- ▶ Turn switch (b) anti-clockwise into the blue area.

The temperature in the driver's area is reduced.

Driver's area - adjusting the blower speed

Driver's area - adjusting the blower speed

i **Note:**

Precondition: electrical system on, engine running.

i **Note:**

The blower speed in the driver's area is continuously variable.



M83_00-0055-01

- ▶ Turn switch (c) clockwise.

The blower speed is increased.

i **Note:**

Maximum blower speed is not available unless the engine is running.

i **Note:**

In economy mode with the electrical system switched on but with the engine switched off, the blower will operate only at minimum speed.

- ▶ Turn switch (c) anti-clockwise.
The blower speed is reduced.

Driver's area - cooling

Driver's area - cooling



Note:

Precondition: engine running, switch “b” in the blue area, outside temperature above 12 °C.



Note:

In buses with a roof-mounted air-conditioning system (refer to vehicle variant description), driver's area cooling can be activated only in conjunction with passenger compartment cooling.



M83_00-0120-01

- ▶ Press pushbutton (11.2).



Note:

The air-conditioning system must be operated at least once a month (even in the cold season) in order to maintain the leak-tightness of the slide ring seal on the compressor crankshaft.



Note:

The maintenance program for the compressor cannot be operated unless the outside temperature is above 0 °C and the coolant temperature (engine circuit) is above 50 °C.

Driver's area cooling control is activated.

The indicator lamp in pushbutton (11.2) lights up.

- ▶ Press pushbutton (11.2) again.

Driver's area cooling control is deactivated.

The indicator lamp in pushbutton (11.2) goes out.

Additional driver's area ventilation (option)



Note:

Precondition: electrical system on.



M83_00-0753-71

- ▶ Turn rotary knob (1) clockwise to increase blower output.
The air distribution can now be set using air vents (2).

Switching air-recirculation mode on and off



Note:

Precondition: electrical system on.



M83_00-0121-01

- ▶ Press pushbutton (11.3).
The indicator lamp in pushbutton (11.3) lights up.
The roof hatches are closed.
The fresh-air flaps are closed.
The roof ventilators switch off.



Note:

Air-recirculation mode remains active for approximately 10 minutes. Normal mode is resumed automatically after this time.

- ▶ Press pushbutton (11.3) again.
The indicator lamp in pushbutton (11.3) goes out.
The roof hatches are opened.
The fresh-air flaps are opened.
The roof ventilators switch on.

Passenger compartment – switching automatic temperature regulation on and off - code HH2/HK1

Passenger compartment – switching automatic temperature regulation on and off - code HH2/HK1

Note:

Precondition: electrical system on, engine running.

Note:

With the engine switched off, economy mode is active and the roof ventilators remain switched off.

Note:

If the electrical system has been switched on but the engine is not running, the blowers operate only at the lowest output level.

Note:

Passenger compartment cooling is activated only if the interior temperature rises above 22 °C.



M83_00-0122-01

- ▶ Press pushbutton (11.4).

Automatic passenger-compartment temperature regulation is switched on.

The indicator lamp in pushbutton (11.4) lights up.

Note:

The temperature in the passenger compartment is regulated automatically in line with the outside temperature and the desired temperature set for the passenger compartment.

Note:

Blower output is infinitely increased or reduced and the roof ventilators are switched on or off in line with the temperature in the passenger compartment.

- ▶ Press pushbutton (11.4) again.
Automatic passenger-compartment temperature regulation is switched off.
The indicator lamp in pushbutton (11.4) goes out.

Passenger compartment – switching automatic temperature regulation on and off



Note:

All current settings are retained whenever passenger-compartment regulation is switched off. Automatic regulation is re-activated when passenger-compartment regulation is switched on again.

Passenger compartment – switching automatic temperature regulation on and off



Note:

Precondition: electrical system on, engine running.



Note:

With the engine switched off, economy mode is active and the roof ventilators remain switched off. If the electrical system has been switched on but the engine is not running, the blowers operate only at speed 1. Fresh air is fed into the passenger compartment through the hinged windows and by the roof ventilators.



M83_00-0122-01

- ▶ Press pushbutton (11.4).

Automatic passenger-compartment temperature regulation is switched on.

The indicator lamp in pushbutton (11.4) lights up.



Note:

The temperature in the passenger compartment is regulated automatically in line with the outside temperature and the desired temperature set for the passenger compartment.

Switching the auxiliary heating on and off



Note:

Blower output is infinitely increased or reduced and the roof ventilators are switched on or off in line with the temperature in the passenger compartment.

- ▶ Press pushbutton (11.4) again.
Automatic passenger-compartment temperature regulation is switched off.
The indicator lamp in pushbutton (11.4) goes out.

Switching the auxiliary heating on and off



Note:

Precondition: electrical system on.



Danger.

Risk of poisoning and asphyxiation. The auxiliary heating must not be used in enclosed spaces such as garages or workshops due to the risk of poisoning and asphyxiation. Timer and preselection mode are similarly prohibited.



Danger.

Risk of explosion. The auxiliary heating must be switched off at filling stations and fuel dispensing systems due to the risk of explosion.



Danger.

Risk of fire. The auxiliary heating must remain switched off in places where ignitable vapours or dust can accumulate (e.g. in the vicinity of filling stations, fuel depots, or coal, sawdust or grain stores or similar).



Danger.

Risk of fire and burns. There is a risk of fires and burns due to the high exhaust temperatures and the hot exhaust pipe for the auxiliary heating. For this reason, do not stop or park the bus over ignitable materials (e.g. grass) when the auxiliary heating is in operation, has recently been in operation or has been operated by the instant heating button/preset timer.



Note:

Operation of the auxiliary heating is limited to approximately 30 minutes with the electrical system switched off.



Note:

The auxiliary heating has to be switched on manually. It is not activated automatically.



M83_00-0123-01

- ▶ Press pushbutton (11.5).

The auxiliary heating switches on after approximately 10 to 15 seconds.

The indicator lamp in pushbutton (11.5) lights up.



The following appears on the screen: “Auxiliary heating on”.



Note:

Each press of the pushbutton initiates an auxiliary heating start-up attempt. The auxiliary heating will be disabled electronically after 10 unsuccessful start-up attempts.



Note:

To re-enable the auxiliary heating: switch the on-board power supply off and on.

- ▶ Press pushbutton (11.5) again.

The auxiliary heating system switches off.

The indicator lamp in pushbutton (11.5) goes out.



The “Auxiliary heating on” indication display on the screen goes out.

Switching the reheat function on and off



Note:

If the bus is not equipped with an auxiliary heating system, pressing pushbutton (11.5) only switches the recirculation pump for the heating on and off.

The run-on time begins and lasts approximately 90 to 120 seconds.

Switching the reheat function on and off



Note:

Precondition: electrical system on, engine running.



Note:

The recirculated air (i.e. the reduced amount of fresh air) is cooled as it comes into contact with the refrigerant evaporator and reheated by the heat exchanger for the heating system. This process condenses water out of the air passed through the system. The air directed to passengers or the driver is thereby dehumidified.



M83_00-0124-01

- ▶ Press pushbutton (11.6).

Dehumidified air is delivered from the air vents.

The indicator lamp in pushbutton (11.6) lights up.



Note:

The reheat function remains active for a maximum of approximately 30 minutes.

Passenger-compartment temperature - changing the base value

- ▶ Press pushbutton (11.6) again.

The reheat function is switched off.

The air delivered from the air vents is no longer dehumidified.

The indicator lamp in pushbutton (11.6) goes out.

Passenger-compartment temperature - changing the base value



Note:

Precondition: electrical system on.



Note:

In case you want to change the target temperature in the passenger compartment, the control panel enables you to change the temperature base value setting within defined limits. 24 °C is the default base value programmed for the temperature in the passenger compartment and assigned to temperature regulation pushbutton (11.4). This base value can be increased to a maximum of 28 °C or reduced to a minimum of 20 °C in increments of 2 °C.



M83_00-0125-01

- ▶ Press and hold pushbutton (11.4) for at least 10 seconds.

The indicator lamps in pushbuttons (11.3), (11.4) and (11.5) may flash individually or in combination, depending on the base value currently set.

Passenger-compartment temperature - changing the base value



M83_00-0121-01

- ▶ Press pushbutton (11.3).

The base value is increased. Press once = increase by 2 °C. Press twice = increase by 4 °C.



Note:

The base value can be increased by a maximum of 4 °C.



M83_00-0123-01

- ▶ Press pushbutton (11.5).

The base value is decreased. Press once = decrease by 2 °C. Press twice = decrease by 4 °C.



Note:

The base value can be decreased by a maximum of 4 °C.



M83_00-0122-01

- ▶ Press pushbutton (11.4) again.

Adjustment of the base value is confirmed.

The indicator lamps stop flashing.

The control unit switches back to normal operation.

Passenger-compartment temperature - changing the base value



M83_00-0123-01

The following base value settings are possible: base value setting 20 °C. The indicator lamp in pushbutton (11.5) flashes.



M83_00-0126-01

Base value setting 22 °C. The indicator lamps in pushbuttons (11.4) and (11.5) flash.



M83_00-0122-01

Base value setting 24 °C. The indicator lamp in pushbutton (11.4) flashes.



Note:

By default, temperature regulation pushbutton (11.4) is programmed for a value of 24 °C.

Opening the roof hatches



M83_00-0127-01

Base value setting 26 °C. The indicator lamps in pushbuttons (11.3) and (11.4) flash.



M83_00-0121-01

Base value setting 28 °C. The indicator lamp in pushbutton (11.3) flashes.

Opening the roof hatches



Note:

Precondition: electrical system on, temperature control off, windscreen wipers off.



M54_00-1318-71

- ▶ Press the upper section of pushbutton (5).

The roof hatches are raised at the rear ('air out' position).



Note:

The red indicator lamp in the pushbutton lights up.

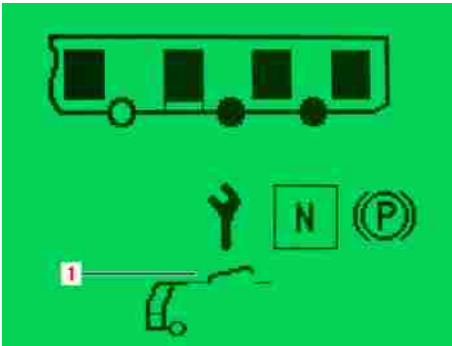

M68_00-0235-71

- ▶ The roof hatches are indicated on the screen as being in air-out position (1).



M54_00-1318-71

- ▶ Press the upper section of pushbutton (5) again.

The roof hatches are raised at the front and rear.

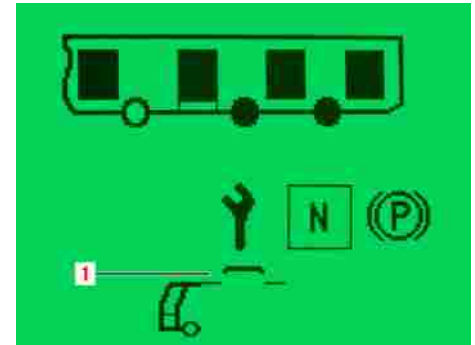

M68_00-0236-71

- ▶ The roof hatches are indicated on the screen as being in open position (1).

Opening the roof hatches



M54_00-1318-71

- ▶ Press the upper section of pushbutton (5) again.

The roof hatches are raised at the front ('air in' position).

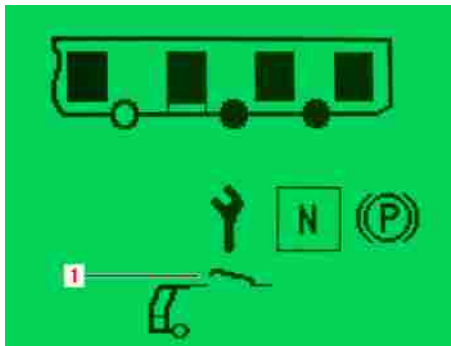

M68_00-0237-71

- ▶ The roof hatches are indicated on the screen as being in 'air in' position (1).



M54_00-1318-71

- ▶ Press the upper section of pushbutton (5) again.

The roof hatches close. The red indicator lamp in the pushbutton goes out.



Note:

It is possible to close the roof hatches at any time by pressing the lower section of pushbutton (5).



Note:

The roof hatches close automatically when the temperature control or wind-screen wipers are switched on.



Note:

The roof hatches close automatically when the ignition is switched off.

- It is possible to prevent the roof hatches from closing automatically when the ignition is switched off. To do so, press and hold button (5) while the engine is switching off.

The roof hatches remain open (air-out position) and the red indicator lamp in pushbutton (5) lights up.

Fans on/off



Note:

Precondition: engine running.



Note:

Automatic fan switch-on/switch-off is enabled whenever the engine is started.



M54_00-1319-71

- Press the upper section of pushbutton (4).

The fans start to run.

The indicator lamp in pushbutton (4) lights up.



Note:

The fans switch on automatically if the interior temperature is too high (above approximately 22 °C) or air-recirculation mode is switched off.

Switching fans on and off - code HH2/HK1

- ▶ Press the lower section of pushbutton (4).

The fans switch off.

The indicator lamp in pushbutton (4) goes out.



Note:

The fans switch off automatically if the interior temperature is too low or air-recirculation mode is switched on.

Automatic fan switch-on/switch-off is enabled again.

Switching fans on and off - code HH2/HK1



Note:

Precondition: engine on.



Note:

Automatic fan switch-on/switch-off is enabled whenever the engine is started.



M54_00-1319-71

- ▶ Press the upper section of pushbutton (4).

The fans start to run.

The indicator lamp in pushbutton (4) lights up.



Note:

The fans start up automatically if the output of the interior blowers rises to approximately 70 %. – air-recirculation mode is not active.

- ▶ Press the lower section of pushbutton (4).

The fans switch off.

The indicator lamp in pushbutton (4) goes out.



Note:

The fans stop automatically if the output of the interior blowers falls below approximately 62 %, if air-recirculation mode is active or if automatic passenger-compartment regulation is not active.

Auxiliary heating digital timer (option)

Auxiliary heating digital timer
(option)

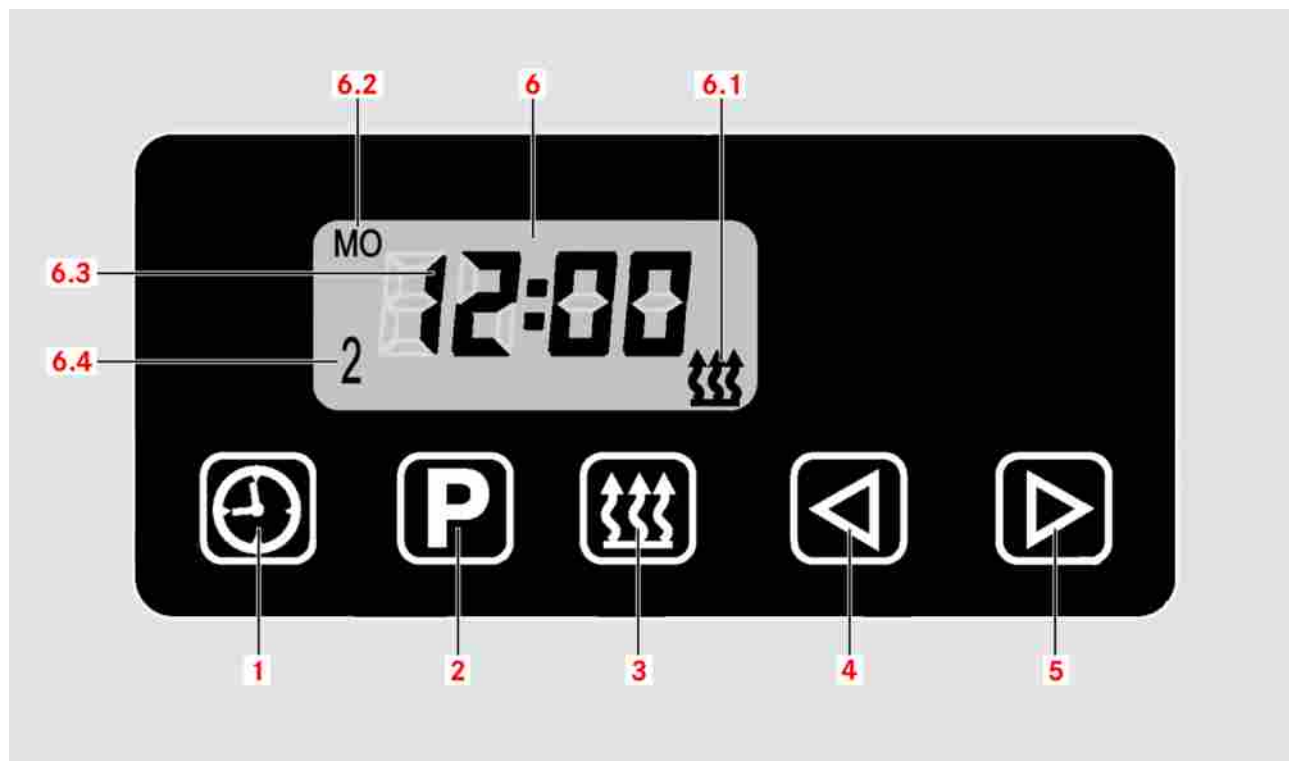

Auxiliary heating operation (option)

- 1 Time button: Display time/set time (press for longer than 2 seconds)
- 2 Program selection: Heating start preset time: display, set, delete
- 3 Instant heating: Switch auxiliary heating on and off manually
- 4 Back
- 5 Forward
- 6 Screen display
- 6.1 Operating display
- 6.2 Weekday
- 6.3 Time display
- 6.4 Storage location

Auxiliary heating operation (option)



Danger.

Risk of explosion and suffocation. Heater operation is not permitted: at filling stations or fuel dispensing systems, in places where ignitable vapours or dust can accumulate (e.g. in the vicinity of filling stations, fuel depots, or coal, sawdust or grain stores), in enclosed spaces (e.g. bus depot).



Caution:

The heater must be operated at least once a month, with the engine cold, for at least 10 minutes



Note:

The timer can be used to preset the heating start time for a period of up to seven days. It is possible to program three switch-on times, although only one can be activated. The clock displays the current time and the weekday when the ignition switch is switched on. The display and

buttons are lit when the heater is in operation. All symbols flash in the indication display after the power supply is connected. The time and the weekday must be set.



Note:

If the ignition switch is switched off and the heating unit is in continuous heating mode, a remaining time of 15 minutes appears in the display and the heating unit continues to operate.

Auxiliary heating operation (option)

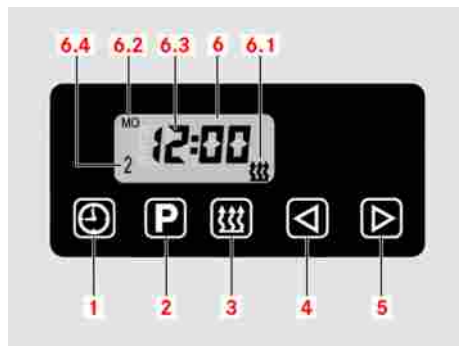

M83_00-0730-71

- ▶ Control of the clock was designed in such a way that all flashing symbols can be adjusted using buttons (4) and (5). The displayed time is stored if 5 seconds pass without a switch being pressed. Fast mode is enabled when buttons (4) and (5) are pressed down for longer than 2 seconds.

- ▶ Switch on the auxiliary heating with digital timer: press button (3).

The auxiliary heating is switched on manually.

- ▶ Switch off the auxiliary heating: press button (3) again.

The auxiliary heating is switched off manually.

- ▶ Call up the time with the ignition switched off: press button (1).
- ▶ Set the time or day: press down button (1) for longer than 2 seconds

Time (6.3) flashes.

- ▶ Adjust the time with buttons (4) and (5).

Now the weekday (6.2) flashes, it can be adjusted with buttons (4) and (5).

- ▶ Program the start of heating (preset time): press button (2).

Storage location 1 (6.4) flashes.

- ▶ Adjust the time with buttons (4) and (5).

Weekday (6.2) flashes.

- ▶ Adjust the weekday with buttons (4) and (5).

Time (6.3) flashes.



Note:

Storage locations 2 and 3 (6.4) can be adjusted using the same procedure by repeatedly pressing button (2).

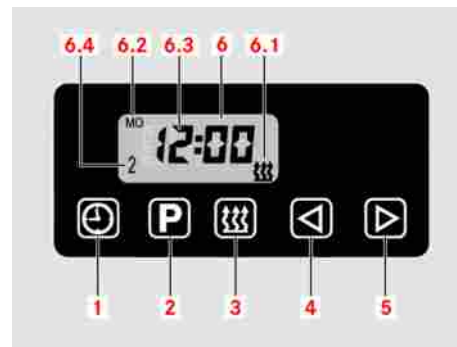

M83_00-0730-71

- ▶ Display preset times: repeatedly press button (2) until the required storage location is displayed.

- ▶ Deactivate the preset time: press button (2) repeatedly until the time is displayed without a storage location (6.4).

- ▶ Program the switch-on duration: the heater must be OFF. Press down button (4) for three seconds.

Switch-on duration flashes

- ▶ Set the desired switch-on duration using buttons (4) and (5).



Note:

The switch-on duration can be set between 10 and 120 minutes.

- ▶ Adjust remaining time: set the desired remaining time using buttons (4) and (5).



Note:

The remaining time is the time for which the heater remains in operation. It can only be changed when the heating unit is operating and the ignition switch is off.



Note:

The remaining time can be set between 10 and 120 minutes.

Protection against entrapment in the door opening direction	209
Protection against entrapment in the door closing direction	209
Emergency operation - doors	210
Forced door closure in an emergency	212
Opening/closing door 1 from the outside	214
Locking/unlocking the door leaves from the outside	214
Opening/closing door 1 from the outside	215
Opening/closing door 1 from the outside	216
Locking door 1 with the key (option)	216
Locking/unlocking the door leaves from the inside	217
Opening/closing the doors from the inside	218
Opening/closing automatic doors from the inside	219
Opening/closing automatic doors from the outside	221
Opening/closing automatic doors	223

Table of contents

Switching between automatic and manual door operation	225
Teaching in the doors in the closing and opening directions	227
Pushchair stop request	231

Protection against entrapment in the door opening direction

Protection against entrapment in the door opening direction

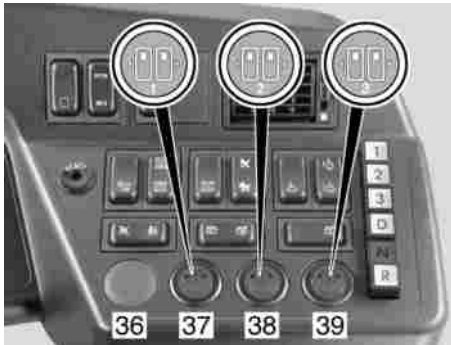

M54_00-0632-01

If a door makes contact with an object when opening, the door leaf concerned is switched to reduced-power pushback.

The indicator lamp in the pushbutton pressed (37/38/39) flashes.

The door then continues to move in the opening direction.

Protection against entrapment in the door closing direction

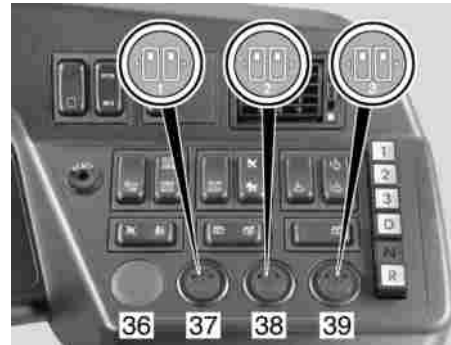

M54_00-0632-01

If a door makes contact with an object when closing, the closing motion is reversed to open the door again.

The indicator lamp in the pushbutton pressed (37/38/39) lights up.

On automatic doors, the closing movement is reinitiated after the hold-open time has elapsed.

Emergency operation - doors

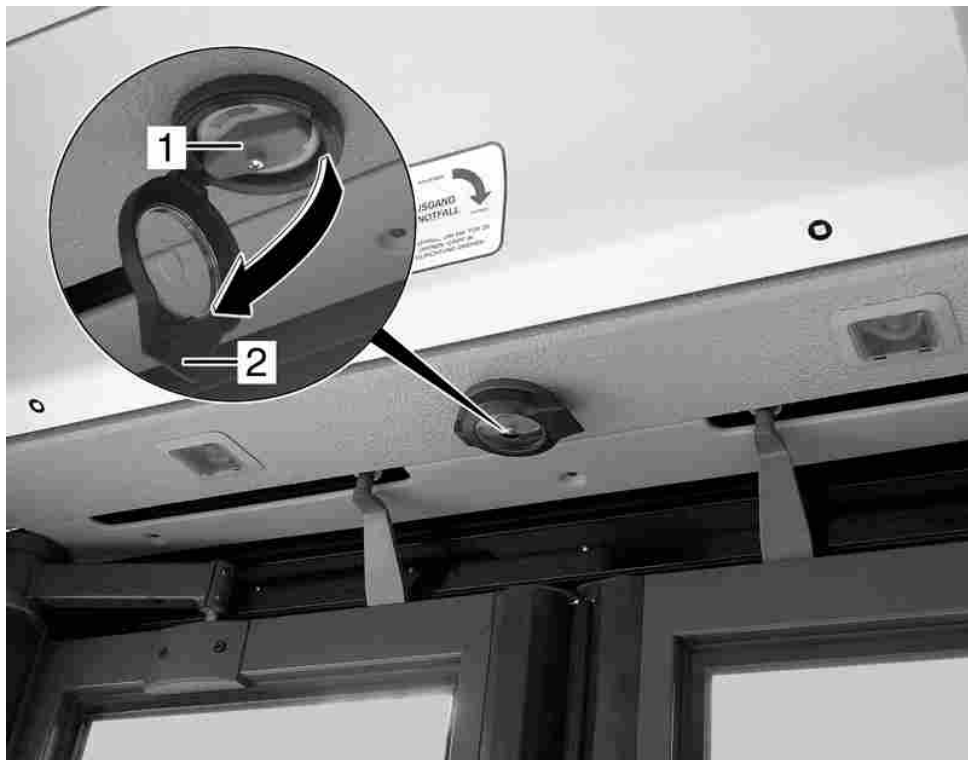

Emergency switch location

**Danger.**

Risk of accident. Only use the emergency switch in emergencies.

**Note:**

There is one interior and one exterior emergency switch at each of the doors.

**Note:**

Observe the laws and regulations in all countries concerned.

- 1 Emergency switch
 - in drive position, when the red handle strip on the emergency switch is parallel to the direction of travel,
 - in emergency position, when the red handle strip on the emergency switch is turned 90° relative to the direction of travel.

- 2 Emergency switch cover:
 - Open cover (2) before operating emergency switch (1).
 - Opening the doors in an emergency: Turn the emergency switch in the direction of the arrow from the drive position to the emergency position. The door leaves can be opened manually.

**Note:**

Warning functions when the electrical system is switched on: the red warning lamp lights up. The “Emergency switch operated” malfunction display is shown on the screen. A signal sounds. The corresponding door pushbutton on the instrument panel flashes.

**Note:**

Exterior emergency switch (1) next to the doors makes it possible for rescuers to gain access to the vehicle interior from the outside in the event of an emergency or an accident.

**Danger.**

All doors must be unlocked before departure (refer to the “Locking/unlocking the door leaves from the inside” or “Locking/unlocking door leaves from the outside” subsections in the “Opening/locking” section of the Operating Instructions). It may otherwise not be possible to open the doors urgently from the outside in an emergency.

Forced door closure in an emergency



Note:

The doors must be relocked when the vehicle is parked to prevent unauthorised access to the vehicle interior.

Close the doors: Turn the emergency switch in the opposite direction to the arrow from the emergency position to the drive position.



Note:

The warning functions are deactivated if the corresponding door pushbutton on the instrument panel is pressed and there is sufficient reservoir pressure.

Forced door closure in an emergency



Note:

Precondition: bus stationary, parking brake applied, on-board power supply on, electrical system on.



Note:

A faulty door may be able to be forcibly closed depending on the malfunction cause.



Caution:

In the event of a malfunction, have the door system checked immediately at an EvoBus Service Partner.

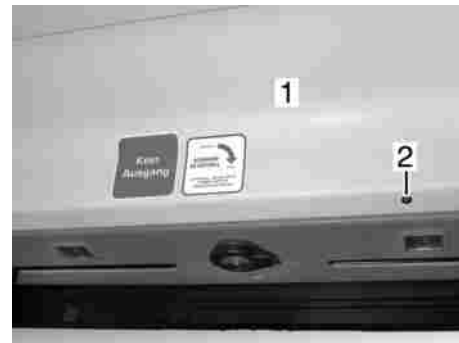

M72_00-0066-01

- ▶ Release (2) and open service cover (1) above the relevant door.

Forced door closure in an emergency

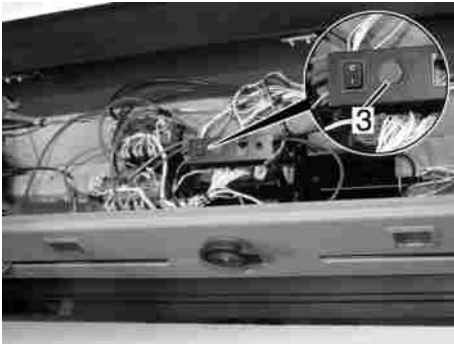

M72_00-0068-01

- ▶ Press and hold workshop pushbutton (3) until the door is closed.

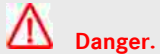

Danger.

Anti-entrapment protection is inoperative if the workshop pushbutton is pressed in an emergency operation.

The door is now forcibly closed.

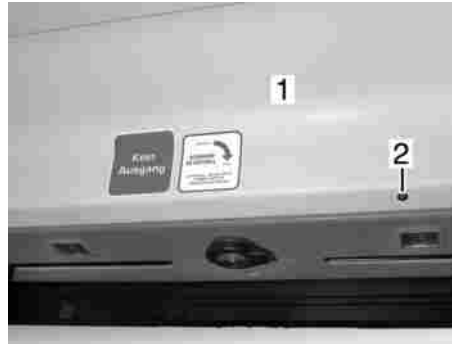

M72_00-0066-01

- ▶ Close and lock (2) service cover (1).

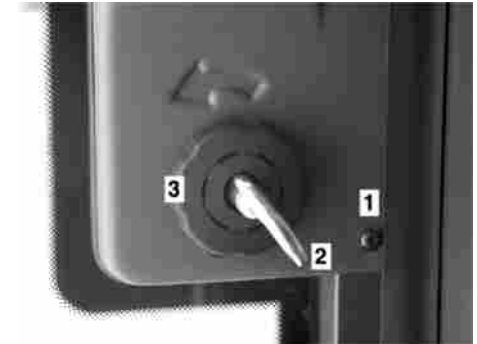

M72_00_0026-01

- ▶ Lock both door leaves from the inside with square key (2).



Caution:

In the event of a malfunction, have the door system checked immediately at an EvoBus Service Partner.

Opening/closing door 1 from the outside

Opening/closing door 1 from the outside



Note:

Precondition: battery voltage 24 ± 3 volts.



M72_00-0262-71

- ▶ To open door 1, press pushbutton (1) precisely in the centre (pressure point).



Note:

If pushbutton (1) is pressed in an area away from the centre, door 1 does not open. This is designed to prevent unauthorised persons from opening the door.



Note:

Door 1 does not open if it has been mechanically locked.

- ▶ To close door 1, press pushbutton (1) precisely in the centre (pressure point).

Locking/unlocking the door leaves from the outside



Note:

All door leaves must be unlocked before the bus is driven.



M72_00-0024-01

- ▶ Turn lock (3) upwards (4) with square key (1).

Lock indicator (2) is black. The door leaf is locked.

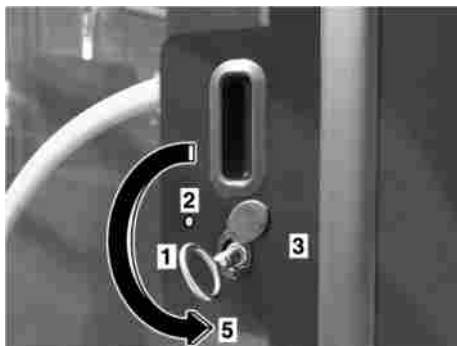

M72_00-0025-01

- ▶ Turn lock (3) downwards (5) with square key (1).

Lock indicator (2) is green. The door leaf is unlocked.

Opening/closing door 1 from the outside



Note:

Precondition: battery voltage 24 ± 3 volts.

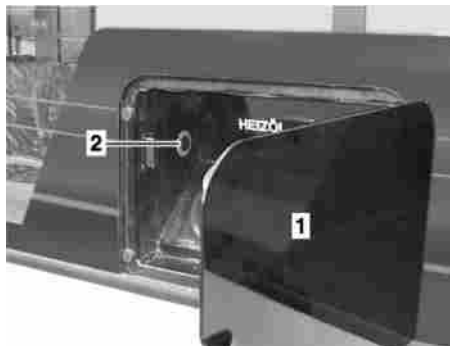

M72_00-0028-01

- ▶ Open fuel filler flap (1).
- ▶ Press pushbutton (2).

Keep pushbutton (2) pressed until door 1 opens.



Note:

The way in which pushbutton (2) is operated may differ from the method described here depending on customer options.

- ▶ Press pushbutton (2).
- Keep pushbutton (2) pressed until door 1 closes.

Opening/closing door 1 from the outside

Opening/closing door 1 from the outside



Note:

Precondition: battery voltage 24 ± 3 volts.

- ▶ Open the front flap above the right-hand headlamp.

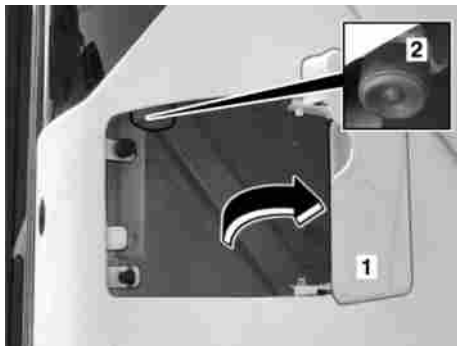

M72_00-0027-01

- ▶ Press pushbutton (2).

Keep pushbutton (2) pressed until door 1 opens.



Note:

The way in which pushbutton (2) is operated may differ from the method described here depending on customer options.

- ▶ Press pushbutton (2).
Keep pushbutton (2) pressed until door 1 closes.

Locking door 1 with the key (option)

- ▶ Whenever you disembark, lock door 1 from the outside using the key.



Note:

If the locked door was unlocked from the inside using the handwheel, the door cannot be locked from the outside again until the unlocking mechanism has been released.

Locking/unlocking the door leaves from the inside



M72_00-0399-71

- ▶ To do this, using a long, pointed object (e.g. a screwdriver), operate the unlocking mechanism through opening (1) and simultaneously turn the handwheel in the opposite direction to the printed arrow.

The door can now be locked from the outside using the key again.

Locking/unlocking the door leaves from the inside

 **Note:**

All door leaves must be unlocked before the bus is driven.

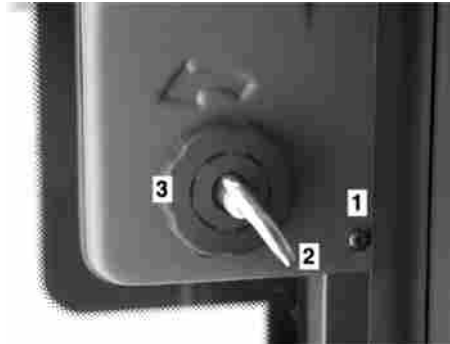

M72_00_0026-01

- ▶ Turn lock (1) with square key (2) in the opposite direction to the arrow.
The door is locked.

**Note:**

The door leaf can only be locked with square key (2).

- ▶ Turn lock (1) in the direction of the arrow using square key (2) or handwheel (3).

The door is unlocked.

**Note:**

Handwheel (3) is only capable of unlocking the door leaf.

Opening/closing the doors from the inside

Opening/closing the doors from the inside



Note:

Precondition: bus stationary, electrical system on.



Danger.

Do not drive the bus unless the doors are properly closed.

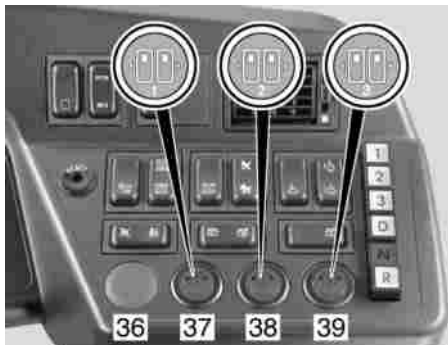

M54_00-0632-01

- ▶ Press one of pushbuttons (37) to (39).
- The relevant door(s) open(s).
- The indicator lamp in the pushbutton pressed lights up.

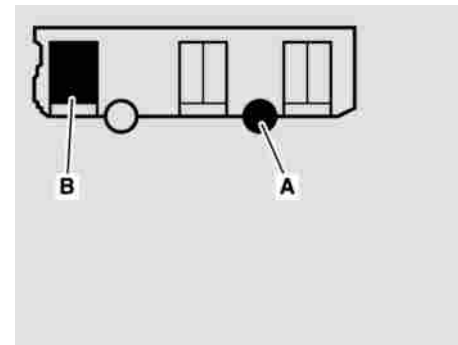

M54_00-0235-01

- The following is shown on the screen:
“Drive-off lock/bus stop brake activated” (A). “Door 1 and/or door 2, 3 open” (B).
- ▶ Press one of pushbuttons (37) to (39) again.
- The relevant door closes.
- The indicator lamp in the pushbutton pressed goes out.

Opening/closing automatic doors from the inside

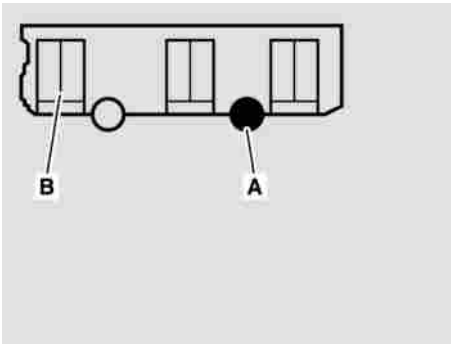

M54_00-0244-01

The following is shown on the screen:
 “Drive-off lock/bus stop brake activated” (A). “All doors closed” (B).

The bus is ready to depart.

i **Note:**

The drive-off lock is released as soon as the accelerator pedal is depressed and it is possible to pull away.

Opening/closing automatic doors from the inside

i **Note:**

Precondition: electrical system on, all doors unlocked.

⚠ **Danger.**

Open doors increase the risk of accident for passengers. Do not drive the bus unless the doors are properly closed. Only enable the doors for opening using the door enable switch at bus stops and when the bus is stationary.

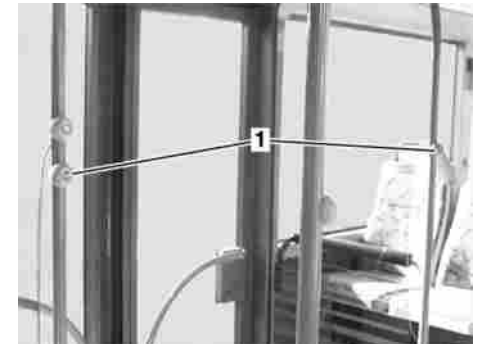

M72_00-0034-01

- ▶ Passenger: press pushbuttons (1) next to the doors.

A signal sounds.

Opening/closing automatic doors from the inside



M82_00-0005-01

The “Bus stopping” or “Stop” passenger information lights up.



The following is shown on the screen: “Stop request” (flashing).



M54_00-0223-01

► Driver: press switch (35) to the right or down.

The door opens automatically when the switch (35) is pressed.



Note:

The door closes automatically after a hold-open time of approximately 3 seconds. The door can then be reopened by the passenger as often as desired while door enable switch (35) is pressed.

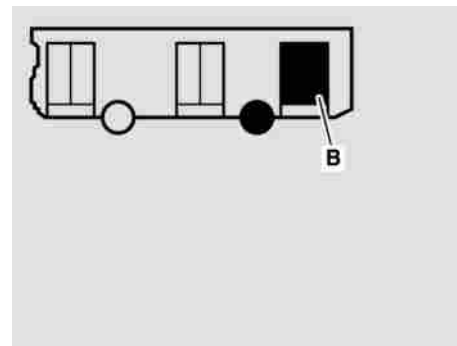

M54_00-0247-01

The following is shown on the screen: “Door open” (B) (door 3 in the example).

Opening/closing automatic doors from the outside



Note:

Precondition: electrical system on, all doors unlocked.



Danger.

Open doors increase the risk of accident for passengers. Do not drive the bus unless the doors are properly closed. Only enable the doors for opening using the door enable switch at bus stops and when the bus is stationary.



M54_00-0223-01

- ▶ Driver: press switch (35) to the right or down.

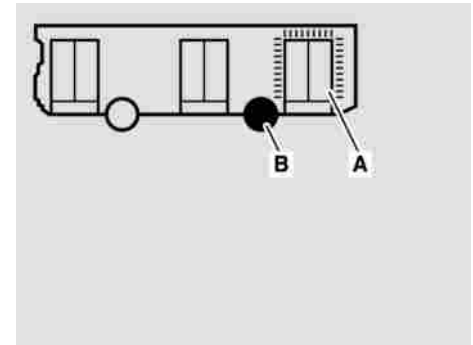

M54_00-0248-01

The following is shown on the screen: “Door enabled” (A) (door 3 in the example) and “Drive-off lock active” (B).

Opening/closing automatic doors from the outside

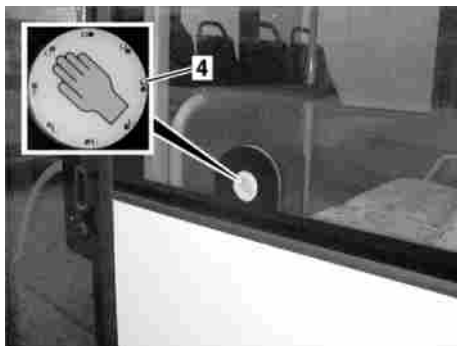

M72_00-0035-01

The green indicator lamps in exterior pushbutton (4) light up and exterior “Open door” pushbuttons (4) are activated (see example).

- ▶ Passenger: press pushbutton (4).

The door opens.

The indicator lamp in the relevant door pushbutton in the driver's area (36 to 39) lights up.

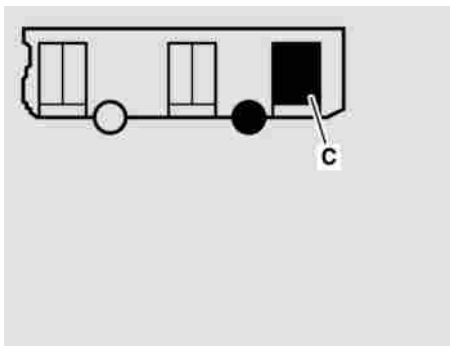

M54_00-0249-01

The following is shown on the screen: “Door open” (C) (door 3 in the example).



The red indicator lamps in the exterior or pushbutton light up briefly if exterior “Open door” pushbutton (4) is pressed.



Note:

The door closes automatically after a hold-open time of approximately 3 seconds.



Note:

The door can be opened as often as desired while the “Door enable” pushbutton is pressed by the driver (35).



The “Stop request” indication display on the screen goes out.

Opening/closing automatic doors



Note:

Precondition: electrical system on, all doors unlocked.



Danger.

Open doors increase the risk of accident for passengers. Do not drive the bus unless the doors are properly closed. Only enable the doors for opening using the door enable pushbutton at bus stops or when the bus is stationary.

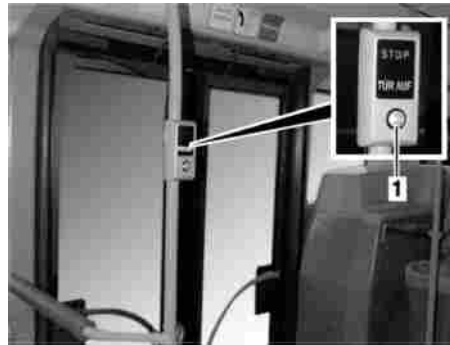

M72_00-0036-01

- ▶ Press pushbuttons (1) next to the doors.

A signal sounds.



M82_00-0005-01

The “Bus stopping” or “Stop” passenger information lights up.



The following is shown on the screen: “Stop request” (flashing).

Opening/closing automatic doors



M54_00-0223-01

- ▶ Driver: press switch (35) to the right or down.

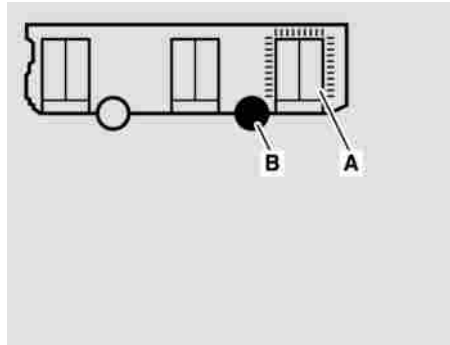

M54_00-0248-01

The following is shown on the screen: “Door enabled” (A) (door 3 in the example) and “Drive-off lock active” (B).

DOOR OPEN is displayed in pushbutton (1) next to the doors.

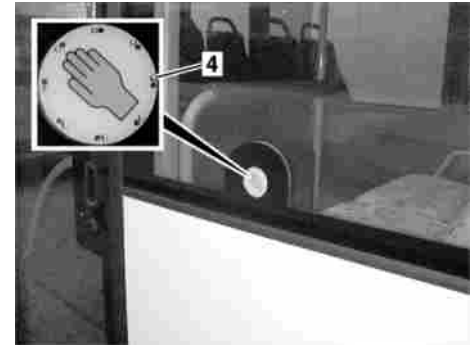

M72_00-0035-01

Exterior pushbuttons (4) are activated and the green indicator lamps in pushbutton (4) light up (see example).

- ▶ Passenger: press pushbutton (1) or (4).

The door opens.

The indicator lamp in the corresponding door pushbutton (36 to 39) lights up.

Switching between automatic and manual door operation

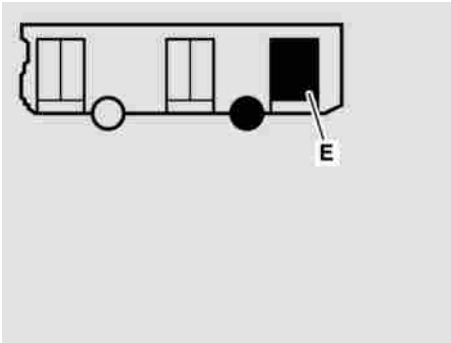

M54_00-0251-01

The following is shown on the screen:
“Door open” (E) (door 3 in the example).

i **Note:**

If pushbutton (4) is pressed, the red indicator lamps in the pushbutton light up briefly.

i **Note:**

The door closes automatically after a hold-open time of approximately 3 seconds.

i **Note:**

The door can be opened as often as desired as long as switch (35) is pressed.



The “Stop request” indication display on the screen goes out.

Switching between automatic and manual door operation

i **Note:**

Precondition: bus stationary, parking brake applied.

⚠ **Danger.**

Risk of accident. The automatic drive-off lock is switched off at door 1 using switch (5) and door operation is not changed to automatic or manual mode.

Switching between automatic and manual door operation

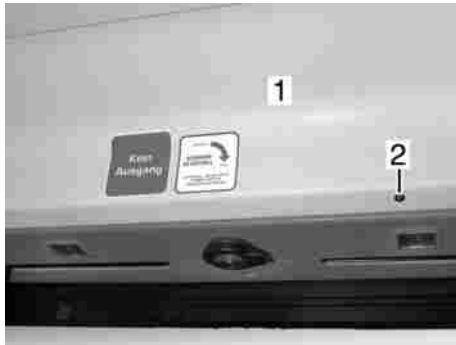

M72_00-0066-01

- ▶ Release (2) and open service cover (1) above the relevant door.

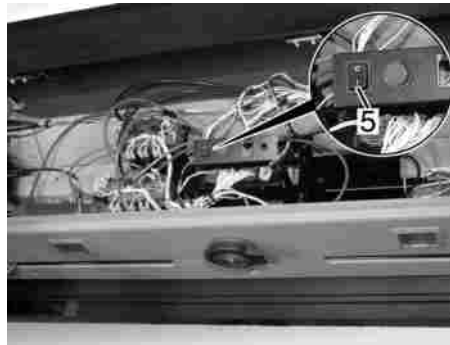

M72_00-0069-01

- ▶ Press switch (5) to position 0.
Automatic operation of relevant door (door 2 or 3) is disabled.
The door cannot be opened by passengers.

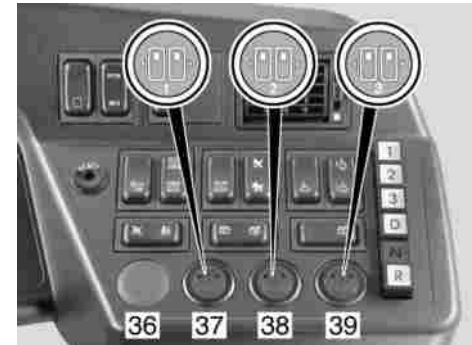

M54_00-0632-01

It is possible to operate the door manually using the corresponding pushbutton (38/39) on the instrument panel.

Teaching in the doors in the closing and opening directions

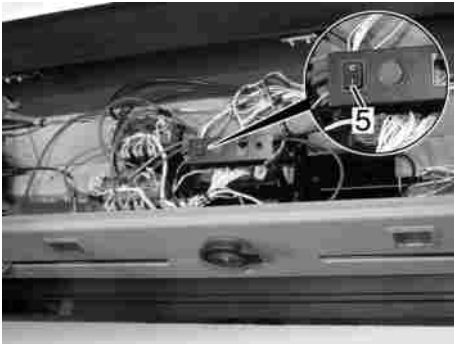

M72_00-0069-01

- ▶ Press switch (5) to position 1.

Automatic operation of relevant door (door 2 or 3) is enabled.

The door can be opened by passengers with the automatic door function enabled.

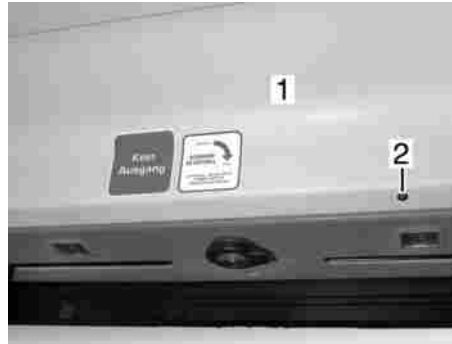

M72_00-0066-01

- ▶ Close and lock (2) service cover (1) above the relevant door.

Teaching in the doors in the closing and opening directions

**Note:**

Precondition: bus stationary, parking brake applied, reservoir pressure > 7 bar, battery voltage 24 V, on-board power supply on, electrical system on.

**Note:**

Teaching-in is not fault correction. If a fault recurs after teach-in has been completed, the cause of the fault must be remedied.

**Note:**

Always teach in door 1 first if malfunctions have occurred simultaneously at door 1 and another door.

Teaching in the doors in the closing and opening directions



Note:

Always teach in doors in both the closing direction and the opening direction.



Caution:

The control unit at door 1 is programmed specifically for the bus. Do not exchange the control units for test purposes.

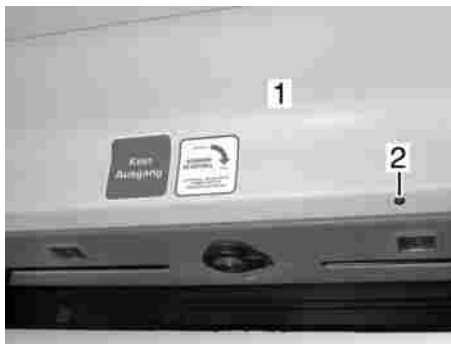

M72_00-0066-01

- ▶ Release (2) and open service cover (1) above the relevant door.

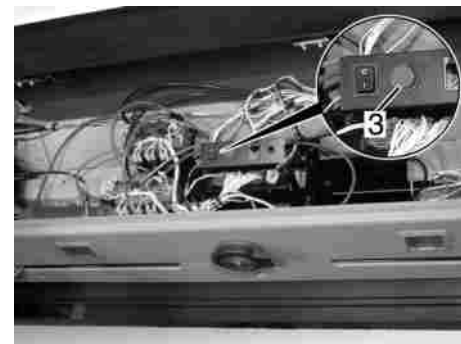

M72_00-0068-01

- ▶ Press and hold workshop pushbutton (3) to teach in the door in the closing direction.

The door closes.

Teaching in the doors in the closing and opening directions

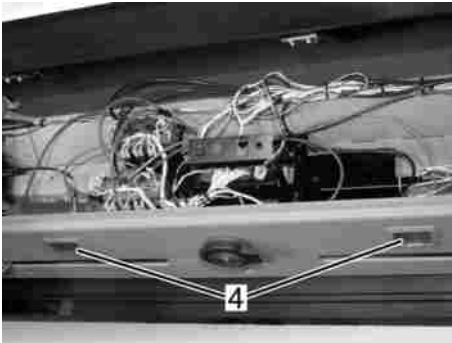

M72_00-0067-01

- ▶ Wait until doorway lamp (4) flashes.

i **Note:**

Flashing indicates that the teach-in process in the closing direction has been completed correctly.

i **Note:**

Doorway lamp (4) flashes once at door 1, twice at door 2 and three times at door 3 etc.

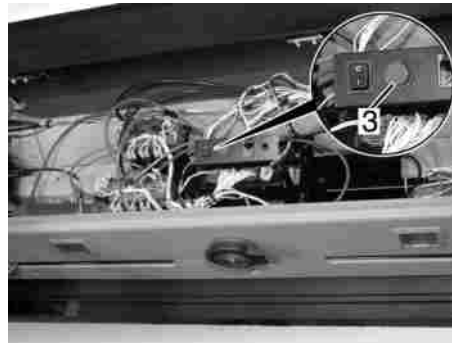

M72_00-0068-01

- ▶ Release workshop pushbutton (3).

i **Note:**

Do not release workshop pushbutton (3) until the flashing sequence is completed (once at door 1, twice at door 2 and three times at door 3, etc.).

The door has been taught in in the closing direction.

- ▶ Press and hold workshop pushbutton (3) to teach in the door in the opening direction.

The door opens.

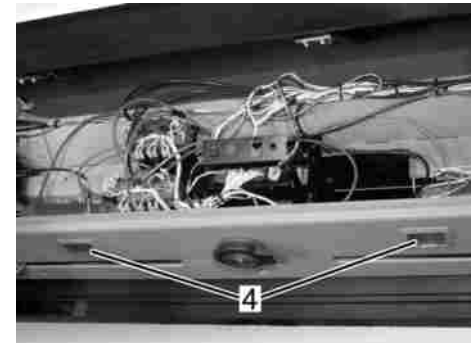

M72_00-0067-01

- ▶ Wait until doorway lamp (4) flashes.

Teaching in the doors in the closing and opening directions



Note:

The flashing indicates teach-in in the opening direction has been completed correctly.



Note:

Doorway lamp (4) flashes once at door 1, twice at door 2 and three times at door 3 etc.

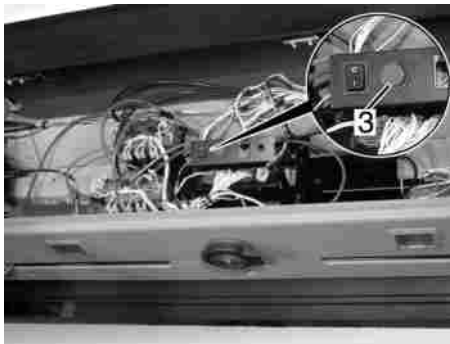

M72_00-0068-01

- ▶ Release workshop pushbutton (3).



Note:

Do not release workshop pushbutton (3) until the flashing sequence is completed (once at door 1, twice at door 2 and three times at door 3, etc.).

The door has been taught in in the opening direction.

- ▶ Firstly switch off the electrical system then the on-board power supply and wait for approximately 5 seconds.

The newly taught-in values are stored in the control unit.

- ▶ Switch the on-board power supply and then the electrical system back on.

The door operates with the newly taught-in values.

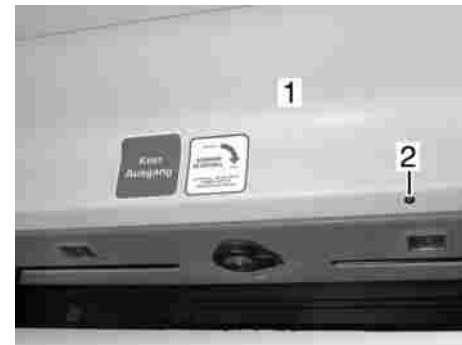

M72_00-0066-01

- ▶ Close and lock (2) service cover (1) above the relevant door.

Pushchair stop request

**Note:**

Precondition: door release activated.

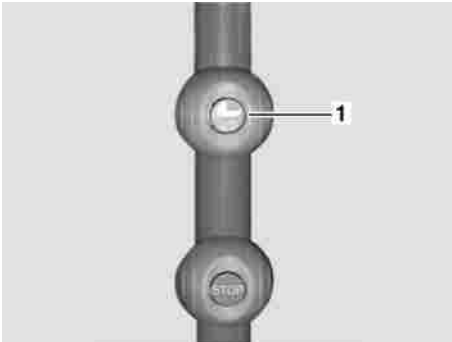

M72_00-0033-01

- ▶ Passenger: press pushbutton (1).

A signal sounds.



M82_00-0005-01

The “Bus stopping” or “Stop” passenger information lights up.

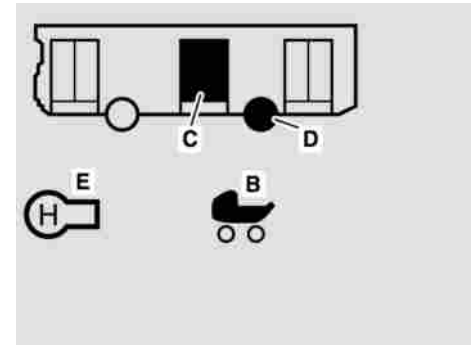

M54_00-0246-01

The following is shown on the screen: “Stop request” (E) (flashing), “Pushchair” (B).

Pushchair stop request



M54_00-0222-01

- ▶ Driver: press the lower section of “Pushchair” switch (28).

i Note:

If the pushchair function is enabled, the door no longer closes automatically but remains open and can only be closed by the driver pressing corresponding push-button (36 to 39) on the instrument panel.

i Note:

The pushchair function is also activated when the driver opens the door.

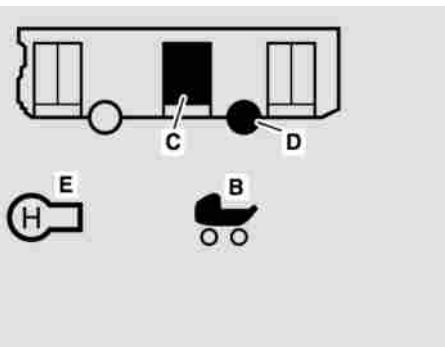

M54_00-0246-01

The following is shown on the screen: “Pushchair” (B) (flashing), “Door open” (C), “Wheel braked” (D).

The “Stop request” indication display (E) goes out.

- ▶ Driver: press the upper section of switch (28).

i Note:

If the pushchair function is disabled by the driver, the door closes automatically after the hold-open time (approximately 3 seconds). Passengers can now open the door again.

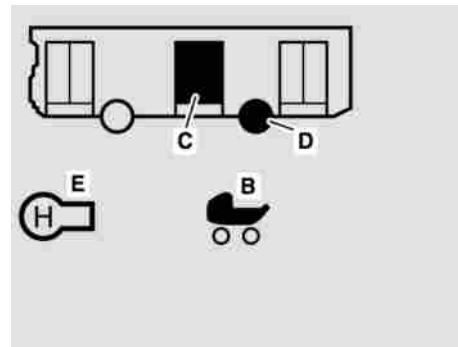

M54_00-0246-01

The “Pushchair” indication display (B) on the screen goes out.

Safety instructions for working in the engine compartment	236
Engine oil level: oil level information on the screen	236
Operating safety and roadworthiness	239
Tyre pressure	239
Tyre tread	240
Tyre condition	240
Tyre age	240
Invisible tyre damage	241
Tyre load capacity, top speed of tyres and types of tyres	241
Retreaded tyres	242
Cleaning the tyres	242
Retightening the wheel nuts	242
Wheel nut tightening torques	243
Snow chains	243
Tyre pressures table	246
Safety measures to be taken in the event of a flat tyre or a wheel change	248

Table of contents

Jacking points	248
Jacking points, front	250
Jacking points, centre (articulated buses only)	250
Jacking points, rear	251
Emergency release of the drive-off lock	252
Parking brake emergency release (option)	253
Electrical system safety precautions	254
General safety precautions for batteries	255
Safety precautions for handling batteries	255
Battery maintenance	256
Recharging the batteries	256
Working on the electrical system and electrical fuses	257
Measures required for the prevention of damage to buses or components during electric welding work	258
Switching the on-board power supply on/off	259
Switching off the on-board power supply at the master safety switch	260

Jump-starting where vehicle batteries are mounted one above the other	261
Jump-starting where vehicle batteries are mounted side by side	264
Jump-starting buses equipped with a battery charging socket	266
Opening the emergency exit in the roof	268
Folding out and folding in headlamps or bumper corner pieces	269
Note on maintenance work	271
Cleaning the underbody	271

Safety instructions for working in the engine compartment

Safety instructions for working in the engine compartment



Danger.

Never leave the engine running when work is being carried out in the engine compartment.



Danger.

Safeguard the engine against being switched on without authorisation. Remove the key from the ignition switch.



Danger.

If the engine is at normal operating temperature, allow it to cool down for some time - risk of burning.

Should it be necessary to change a drive belt as the result of a breakdown and no suitable gauge is available to check the belt tension then the bus must be taken to the nearest EvoBus Service Partner as

soon as possible to check that the belt tension and the tightening torques are correct.

Engine oil level: oil level information on the screen



M54_00-1139-01

The various items of oil level information on the screen are operating displays and are not displayed automatically. They can only be called up by pressing Screen control pushbutton (3) (upper section).



Caution:

There is a risk of engine damage if the oil level is too low or too high. Therefore, correct the oil level as soon as possible.



Danger.

Risk of accident. Calling up additional information manually while the vehicle is in motion would divert your attention away from the road and traffic conditions. This could result in an accident with serious or fatal injuries. For this reason, only call up information manually when the bus is stationary and the parking brake is applied.



Note:

Observe “Calling up/selecting/permanently displaying operating displays” in the “Driver's area controls” section.

Engine oil level OK

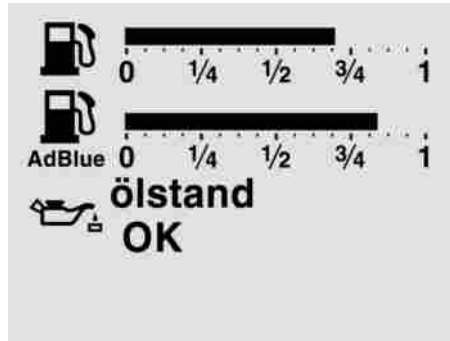

M54_00-1132-01

The “Oil level OK” message indicates that the oil level is in the normal range.



Note:

If the oil level is OK, it is not possible to call up any further oil level information.

Engine oil level too low

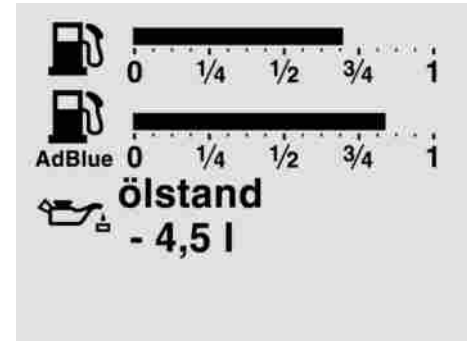

M54_00-1134-01

An insufficient engine oil level is indicated by the “Oil level” message and the top-up amount required in litres (4.5 litres in the example).



Note:

This display is only available if a yellow warning level malfunction or the “Message available” symbol (spanner) has previously been displayed.

Engine oil level: oil level information on the screen



Note:

There is a risk of engine damage if the engine oil level is too low. Therefore, correct the oil level as soon as possible.



Note:

Observe "Malfunction displays" in the "Practical advice" section.

Engine oil level too high

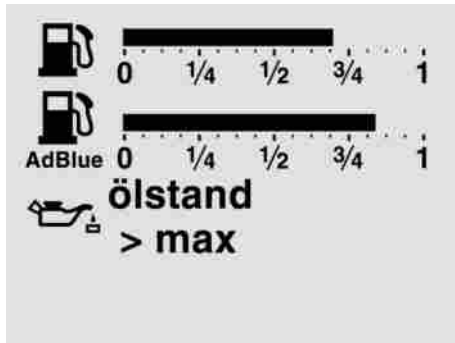

M54_00-1135-01

The engine oil level is too high if the "Oil level > max" message is displayed.



Note:

This display is only available if a yellow warning level malfunction has previously been displayed.



Note:

There is a risk of engine damage if the engine oil level is too high. Therefore, correct the oil level as soon as possible.

Engine oil level cannot be measured



M54_00-1136-01

If the oil level cannot be measured, e.g. due to a sensor fault, this is indicated by the "Oil level - - - -" message.

Operating safety and roadworthiness

Tyres are particularly important for the operating safety and roadworthiness of the bus. The pressure, tread and condition of the tyres should therefore be checked on a regular basis.

Tyre pressure

Check the specified tyre pressure regularly – at least once a week and before longer journeys – when the tyres are cold.



Danger.

Always observe the specified tyre pressures for your bus. The temperature and pressure of the tyres increase when the bus is in motion. For this reason, you should never reduce the pressure of warm tyres. The tyre pressures would then be too low once the tyres had cooled. If the tyre air pressure is too low, the tyre is liable to burst, particularly with increasing numbers of passengers/load and speed. This could result in you losing control of your bus and causing an accident, thereby injuring yourself and other people.



Note:

If the tyre pressure is too low, this leads to intensive heating of the tyres, increased tyre wear, changes in directional stability and increased fuel consumption.



Note:

If the tyre pressure is too high, this results in a longer braking distance, poorer tyre grip and increased tyre wear.



Caution:

Caps on the tyre valves protect the valve inserts from moisture and dirt. The caps on the tyre valves should therefore always be screwed on tightly.

Tyre tread

Tyre tread

A minimum tyre tread depth is specified by law. Comply with the legal specifications for the relevant country.

As the remaining tread depth reduces, the less effective the road grip and handling characteristics of the bus become, particularly on wet or snowy roads.

In the interest of safety, have the tyres replaced before the legally-specified minimum tread depth is reached.



Danger.

Always ensure that there is sufficient tyre tread. Insufficient tyre tread depth increases the risk of aquaplaning if the bus is driven at high speed during heavy rain or in slush. The tyre tread can no longer deflect the water away. This could result in you losing control of your bus and causing an accident, thereby injuring yourself and other people.

Tyre condition

Before setting off, check the tyres on the bus for:

- external signs of damage
- foreign objects in the tyre tread
- foreign objects between twin tyres
- cracks, bulges



Note:

Please note that cracks, bulges or external damage can cause a tyre to burst. This could result in you losing control of the bus and causing an accident, thereby injuring yourself and other people. Have damaged tyres replaced immediately.

Tyre age

Have the tyres changed at least every six years, irrespective of wear. This also applies for the spare wheel.



Danger.

The sun's rays and environmental factors cause tyres to age. The rubber from which the tyre is made loses elasticity. Tyres harden and become brittle, cracks appear due to ageing. Tyres which are more than six years old are no longer reliable.

Invisible tyre damage

Avoid crushing tyres against the kerb or switching off the bus when a part of the tyre tread is up on the kerb.

**Danger.**

Driving over the edge of the kerb or sharp edged objects can cause damage to the tyre substructure which is not visible externally. Damage to the tyre substructure only becomes noticeable much later and could cause the tyre to burst. This could result in you losing control of your bus and causing an accident, thereby injuring yourself and other people.

Tyre load capacity, top speed of tyres and types of tyres**Danger.**

Exceeding the specified tyre load capacity or the approved maximum tyre speed could lead to tyre damage or tyre failure. This could result in you losing control of your bus and causing an accident, thereby injuring yourself and other people. For this reason, only use the approved tyre types and sizes for your bus model and note the required tyre load capacity and speed index for your bus. Pay particular attention to country-specific tyre approval regulations. These regulations may specify a particular type of tyre for your bus or prohibit the use of particular tyre types that may be approved in other countries. In addition, it may be advisable to use a specific type of tyre in certain regions or areas of use. You can obtain information on tyres from any EvoBus Service Partner.

Where twin tyres are fitted, the twin tyres must have the same external diameter, otherwise the tyre that has the

largest diameter will be overloaded. Tip: the simplest and most reliable measurement method is to check circumferences using a circumference tape.

**Note:**

The maximum tolerance for twin tyres is 0.5% of the tyre diameter. The larger tyre must always be fitted in the outboard position.

Retreaded tyres

Retreaded tyres

Retreaded tyres are not inspected for EvoBus and are therefore not recommended. Existing damage is not always detected during retreading. For this reason, EvoBus cannot guarantee the safety of the bus if retreaded tyres are used.

Cleaning the tyres



Danger.

Risk of accident. Clean tyres and suspension air bags very carefully. Round-spray jets must not be used to clean the tyres and suspension air bags. The water jet may damage the tyres. Replace damaged tyres.



Environmental protection

Damage to the environment: only clean the bus at a washpoint intended for this purpose. Heed environmental protection measures.

Retightening the wheel nuts



Danger.

Risk of accident. Regularly check the wheel nuts for firm seating and retighten if necessary. Make sure that the wheel nuts on a new or changed wheel are retightened after driving for 30 miles (approximately 50 km). If new or newly lacquered wheel rims are used you must also retighten the wheel nuts after the bus has driven for 600 to 3,000 miles (approximately 1,000 to 5,000 km). Observe the tightening torques.

Wheel nut tightening torques

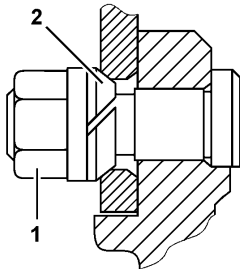

M40_10-0001-01



Danger.

Risk of accident. Observe the tightening torques: pressed-steel wheel with centring by spherical spring washers (2) and wheel bolts 450 Nm.

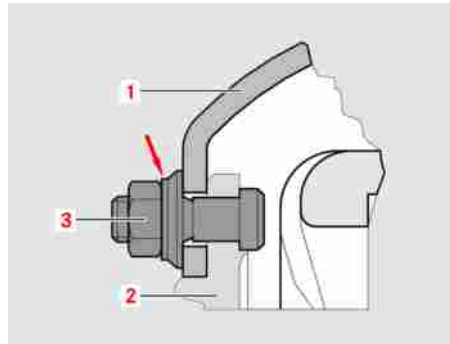

M40_00-0016-01



Danger.

Risk of accident. Observe the tightening torques: pressed-steel wheel with hub centring by wheel hub 600 Nm. Light-alloy wheel with hub centring 600 Nm.

Snow chains

Snow chains



Caution:

Snow chains must not be used on the wheels of the front axle.



Note:

Comply with the manufacturer's fitting instructions and legal requirements.



Note:

Only fine-link snow chains are permitted.



Note:

Raising the bus using the raising/lowering system may make it easier to fit the snow chains.

Snow chains



Danger.

Make sure that the snow chains are fitted tightly. Do not exceed the permitted maximum speed of 25 mph (40 km/h).













Note:

Check that the snow chains are seated firmly after driving for a suitable distance (dependent upon the conditions), retighten if necessary.

Tyre pressures table

Tyre pressures table

	[bar]	5,5	5,75	6,0	6,25	6,5	6,75	7,0	7,25	7,5	7,75	8,0	8,25	8,5	8,75	9,0
		4980	5060	5240	5410	5580	5760	5930	6090	6260	6340	6590	6760	6920	7080	7250
		9000	9320	9650	9970	10280	10600	10910	11220	11530	11840	12140	12440	12740	13040	13340
		4670	4840	5010	5180	5340	5510	5670	5830	5990	6150	6310	6460	6620	6780	6930
		8610	8920	9230	9530	9840	10140	10440	10730	11030	11320	11610	11900	12190	12480	12760
		4240	4400	4550	4710	4850	5010	5150	5300	5440	5590	5730	5870	6020	6160	6300
		7820	8110	8390	8660	8940	9220	9490	9760	10030	10290	10550	10820	11080	11340	11600
 275 / 70 R 22,5																

[bar]

Tyre pressure in bar



Axle load/tyre pressure rating for excursions and touring services



Tyre size 275/70 R 22.5, load index 148



Axle load for single tyres in kg



Axle load for twin tyres in kg



Axle load/tyre pressure rating for public transit buses operated in urban traffic, including journeys involving longer distance routes, e.g. in order to service suburbs and neighbouring towns, provided the average speed does not exceed 40 km/h



Axle load/tyre pressure rating for public transit buses required to operate at road speeds up to a maximum of 60 km/h



Danger:

Risk of accident. An under-inflated tyre impairs driving safety and reduces tyre life. Fuel consumption, tyre wear and risk of tyre damage are increased.



Caution:

Check tyre pressures regularly.



Note:

The values listed in the table are recommended values for tyre size 275/70 R 22.5 - load index 148. For specific or unusual operating conditions, please contact the tyre manufacturer concerned.



Note:

Tyre pressure increases or decreases by approximately 0.2 bar with every 10 °C increase or decrease in air temperature respectively. This must be borne in mind if tyre pressures are checked indoors, especially in the winter.

Example: temperature in the depot approximately 20 °C, outside temperature approximately 0 °C - this means that the tyre pressure to be set = specified tyre pressure + 0.4 bar.

Safety measures to be taken in the event of a flat tyre or a wheel change

Safety measures to be taken in the event of a flat tyre or a wheel change



Danger.

Park the bus as far away as possible from the traffic and on firm ground. Switch on the hazard warning lamps. Let all passengers disembark and move them out of the danger zone (e.g. behind the crash barrier). Position a warning triangle or hazard warning light at a suitable distance. Observe the legal requirements of the country concerned.



Danger.

Only change the wheel on a level, firm and non-slip surface. The bus or jack may slip out to the side on a soft or slippery surface (snow, ice, smooth surface, etc.).



Danger.

Never lie under the bus if it is raised up and is not supported by axle stands. Do not start the engine as there is a risk of fatal injury. Safeguard the engine against being switched on without authorisation. Remove the key from the ignition switch.

Jacking points



Danger.

Risk of accident. Secure the bus against rolling away.



Danger.

Risk of accident. Observe the operating instructions issued by the jack manufacturer.



Danger.

Risk of accident. Never lie under the bus if it has been raised without the additional support of axle stands. Do not start the engine as there is a risk of fatal injury. Prevent the engine from being switched on without authorisation, remove the key from the ignition starter switch.



Danger.

Risk of accident. If the complete bus is to be raised using wheel grippers, multi-post lifts, etc., all axles must be raised simultaneously.



Danger.

Risk of accident. In the interests of safety, the connector to the NR (electronic level control) control unit must be disconnected.



Caution:

When the bus is being lowered, make sure that the suspension air bags are seated correctly and that there is sufficient supply pressure to fill the suspension air bags again.



Caution:

The driven axle and centre axle must never be raised in the middle.



Caution:

The driven axle and trailing axle are interconnected by the suspension. It is prohibited to raise an individual axle to such a height that the wheels on the second axle would be lifted from the ground.



Note:

The whole bus can be raised using the jacking points on the underbody.

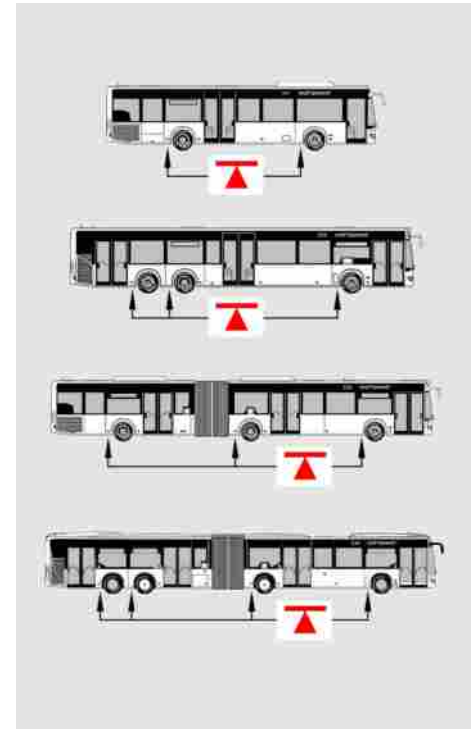

M00_00-0529-73

Jacking points, front

- ▶ Raise the bus at the designated jacking points indicated on the underbody of the bus.

Jacking points, front



Danger.

Secure the bus against rolling away. Apply the parking brake.



M40_00-0075-71

- ▶ Raise the bus at the jacking points on the front axle casing shown in the illustration.

Jacking points, centre (articulated buses only)



Danger.

Secure the bus against rolling away. Apply the parking brake and chock the front wheels.



M00_00-0533-01

- ▶ Raise the bus at the jacking points at the centre of the bus underbody shown in the illustration.

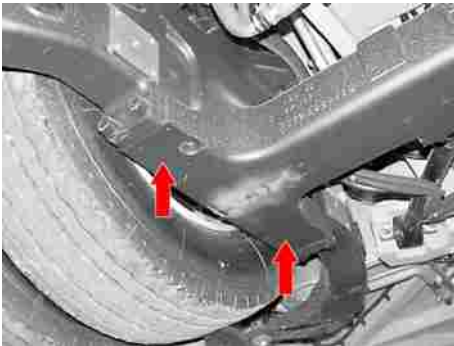

M00_00-0534-01

- ▶ Raise the bus at the jacking points on the centre axle shown in the illustration.



Caution:

Never position the jack at the centre of the axle casing.

Jacking points, rear



Danger.

Secure the bus against rolling away. Apply the parking brake and chock the front wheels.



M00_00-0530-01

- ▶ Raise the bus at the jacking points at the rear of the bus underbody shown in the illustration.

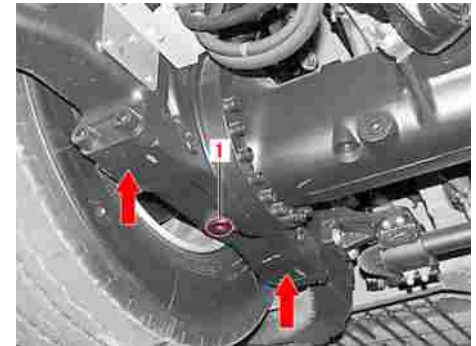

M00_00-0531-01

- ▶ Raise the bus at the jacking points on the rear axle shown in the illustration.



Caution:

Never position the jack against oil drain plug (1) or in the centre of the axle casing.

Emergency release of the drive-off lock

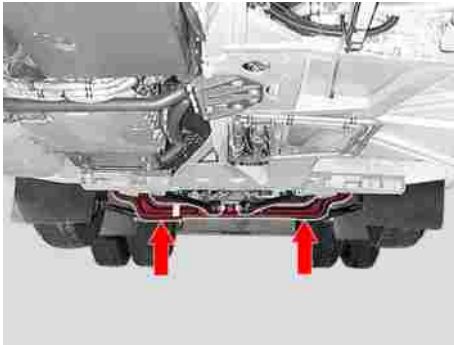

M00_00-0532-01

- ▶ Raise the bus at the jacking points on the trailing axle shown in the illustration.



Caution:

The driven axle and trailing axle are interconnected by the suspension. It is prohibited to raise an individual axle to such a height that the wheels on the second axle would be lifted from the ground.

Emergency release of the drive-off lock



Danger.

This switch has a tamper-evident seal and is intended to be operated only in the event of a malfunction in the bus stop brake or drive-off lock.



Danger.

Make absolutely sure that the parking brake is applied before you operate the bus stop brake emergency release switch. The bus could otherwise roll away.

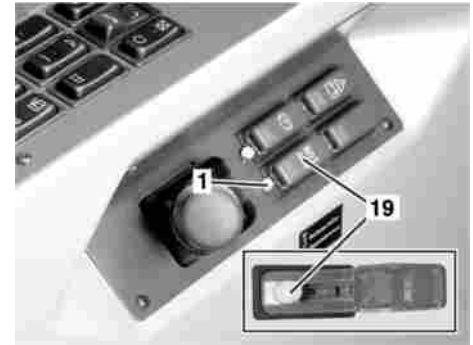

M54_00-0211-01

- ▶ Remove tamper-evident seal (1).
- ▶ Open the switch cover (19).
- ▶ Pull switch (19).

The drive-off lock is released.

A signal sounds with the bus stationary.

Parking brake emergency release (option)



M00_00-0170-01

Yellow warning lamp (14) lights up with the bus stationary.



The “Brake” symbol and the “Bus stop brake malfunction” message are displayed on the screen.



Danger.

Have the malfunction rectified as soon as possible at an EvoBus Service Partner.

Parking brake emergency release (option)



Note:

Precondition: auxiliary consumers operating pressure of more than 5.5 bar, parking brake valve in the released position.



Danger.

Risk of accident. For emergency use only. Secure the bus against rolling away before releasing the spring-loaded parking brake. Rectify faults in the brake system immediately.

Electrical system safety precautions

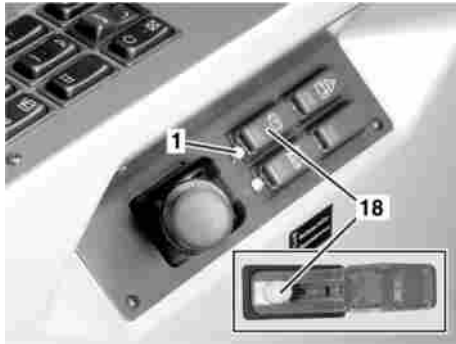

M54_00-0259-01

- ▶ Remove tamper-evident seal (1).
- ▶ Open the cover of emergency release switch (18).
- ▶ Pull switch (18).

The spring actuators are released.



Note:

Switch off the emergency release device before restoring the bus to normal operation.



Note:

Provide the cover with a new tamper-evident seal and secure it with wire.



Note:

Test regularly.

Electrical system safety precautions

For safety reasons, always switch off the battery isolating switch before work is carried out on the electrical system or the batteries are disconnected/reconnected.

Do not connect or disconnect wiring harness connectors to/from electronic control units unless the ignition starter switch is OFF.

During engine washes, always protect the starter, alternator and electrical plug connections from moisture.

Never attempt to bridge or repair fuses.

Use only fuses of the specified amperage. Never replace fuses with those of a higher ampere rating as this could lead to damage to the electrical system.

General safety precautions for batteries



Danger.

Risk of short circuit. Do not place any metal objects on batteries.



Caution:

Do not loosen or disconnect the terminal clamps while the engine is running and electrical consumers are switched on.



Environmental protection

Dispose of defective batteries in an environmentally responsible manner. Observe legal requirements.

Safety precautions for handling batteries



M54_10-0004-01

- (1) - Fire, sparks, naked flames and smoking are prohibited. Prevent sparking.
- (2) - Risk of explosion.
- (3) - Observe the operating instructions.
- (4) - Risk of acid burns. Battery acid is corrosive. Always observe the safety instructions and safety precautions when handling batteries or battery acid. Battery acid must never come into contact with skin, eyes or clothing. Rinse off all acid splashes immediately with copious

amounts of clean water. Seek medical attention if necessary.

- (5) - Wear safety goggles.
- (6) - Keep children away.



Danger.

Naked flames and smoking are strictly prohibited whenever work is being carried out on the vehicle batteries. Avoid the creation of sparks. Wear safety goggles. Keep children away. There is a risk of acid burns. The Operating Instructions must be observed. There may be a risk of explosion.



Danger.

All cells of lead-acid batteries must be fitted with special caps that are interlinked by vent hoses, thereby allowing any gases produced to be directed into the open air.

Battery maintenance



Danger.

If the bus is equipped with lead-acid batteries, it is prohibited to exchange these for gel batteries, and vice versa.

Battery maintenance

- Do not clean the batteries without the cell caps screwed in. Do not use petrol, benzene, kerosene or similar for cleaning.
- Ventilation bores in the cell caps must be open, i.e. the hoses in the cell ventilation must not be blocked.
- Lightly grease the terminal clamps with acid-proof grease, especially the underside.
- Check the securing screws for the terminal clamps and the screw securing the negative cable to the chassis regularly for firm seating.
- Recharge out-of-service batteries once a month or trickle-charge them at 0.06 A. Gel batteries require special chargers having the appropriate charge characteristic (IU, IUOU or WUOU).

Recharging the batteries



Danger.

Risk of injury. Risk of explosion.

Risk of explosion due to oxyhydrogen gas formation. Make sure that there is good ventilation when you charge the batteries.



Caution:

Caution. Do not rapid-charge new batteries under any circumstances.

Working on the electrical system and electrical fuses

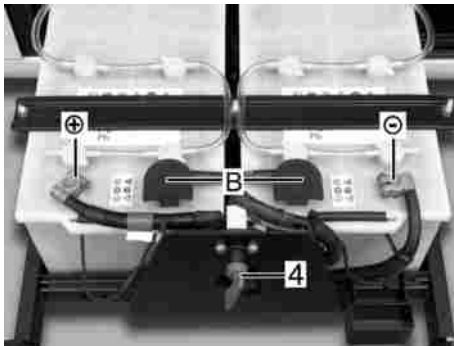

M54_00-0686-01

Working on the electrical system and electrical fuses



Risk of fire.

- Remove the cell caps and terminal clamps from the batteries before recharging. Do not disconnect the connecting cable (B) between the batteries.
- Observe the correct charging voltage (24 volts).
- The charge current should not exceed 10 % of the battery capacity.
- Gel batteries require special chargers having the appropriate charge characteristic (IU, IUOU or WUOU).
- Before any work is carried out on the electrical system, switch off all consumers and disconnect the negative terminal clamps (-) of the batteries.
- Do not reconnect the negative terminal clamps (-) until all electrical lines have been reconnected correctly.
- Before you attempt to change a fuse, switch off all consumers and disconnect the negative terminal clamps (-) of the batteries.
- Never attempt to bridge or repair fuses.
- Use only fuses of the specified amperage. Never replace fuses with those of a higher ampere rating as

this could lead to damage to the electrical system.

- Always rectify the cause of the malfunction before replacing the fuse concerned.

Measures required for the prevention of damage to buses or components during electric welding work

Measures required for the prevention of damage to buses or components during electric welding work

To prevent damage to various components of the bus, the following measures must be taken before welding work is carried out:

- Have a fire extinguisher on standby.
- The clip on the negative terminal of the battery must be disconnected and the negative terminal covered. (Observe the notes on disconnecting the vehicle batteries.)
- The pieces of foam fitted in some of the cavities in the body as sound-proofing must be removed before the commencement of panel work, welding and tin-plating.
- Connect the earth connection of the electric welder directly to the part to be welded. When doing so, make sure that there are no electrically insulating parts between the earth connection and the weld point.
- Heat-sensitive parts, such as plastic tubes, are to be protected or removed.
- Lines routed in cavities, and containers or electronic components that have been fitted concealed, must be removed from the danger area before the start of welding.
- The passenger compartment and glazing must be covered with protective mats to protect them from weld splatter and flying sparks.
- Shield off areas at risk of damage caused by flying sparks and radiant heat.
- Do not allow electronics housings or electrical lines to come into contact with the welding electrode or the earth connection of the welder.
- If two parts are to be welded together, both parts must be connected to the negative clip of the welder.
- The seam points of the part on the bus to be welded and of the earth terminal on the electric welder must be as bare as possible – paint, corrosion, oil, grease and dirt should therefore be thoroughly removed.
- The earth terminal of the welder must not be connected to the transmission. The welding current may cause sparking at the bearing points inside the transmission. The resultant changes in crystalline structure would lead to premature failure of the assembly.



Danger.

The heating effects may cause dense smoke or fires.

Switching the on-board power supply on/off



Note:

Precondition: battery voltage 24 ± 3 volts



M54_00-0213-01

- ▶ Open service cover (1) on the battery compartment.



Note:

The battery compartment contains the following: batteries, battery isolating switch, main fuses for on-board power supply, starter relay.

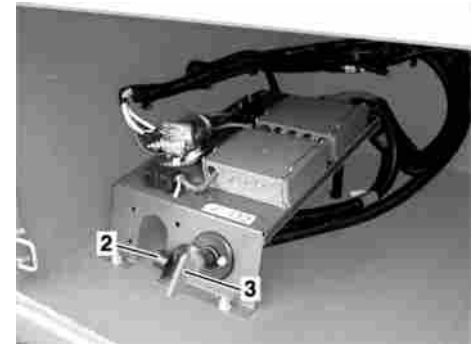

M54_00-0214-01

- ▶ Remove screw cap (2).
- ▶ Insert key (3) and turn it clockwise.

The electrical systems and consumers are connected to the batteries.

The on-board power supply is switched on.

- ▶ Turn key (3) anti-clockwise and remove it.

The electrical systems and consumers are isolated from the batteries.

Switching off the on-board power supply at the master safety switch

The on-board power supply is switched off.

- ▶ Refit screw cap (2).

Switching off the on-board power supply at the master safety switch



Danger.

Do not operate master safety switch (17) except in an emergency and only with the bus stationary.

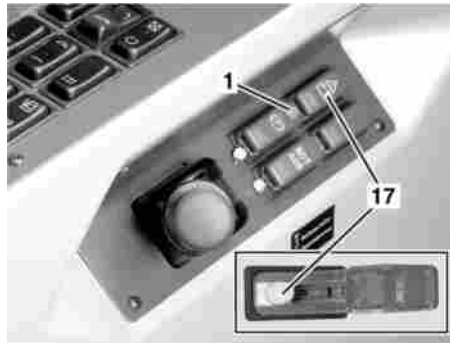

M54_00-0260-01

- ▶ Remove tamper-evident seal (1).
- ▶ Open switch cover (17).

- ▶ Pull switch (17).

The power supply is disconnected.



Note:

All the consumers are isolated from the batteries. Exception: hazard warning lamps with indicator, tachograph and emergency lighting

The engine stops.



Note:

Switch off the master safety switch before starting up the bus.



Note:

Provide the cover with a new tamper-evident seal and secure it with wire.

Jump-starting where vehicle batteries are mounted one above the other



Note:

Test regularly.

Jump-starting where vehicle batteries are mounted one above the other



Danger.

Risk of accident. Secure the bus against rolling away.

- ▶ Turn the key in the ignition starter switch back to the stop (position “0”).



M54_00-0683-01

- ▶ Open the service cover on battery compartment (1).

Practical advice

Jump-starting where vehicle batteries are mounted one above the other



M54_00-0692-01

- ▶ Unscrew the retaining screws for battery support frame (2).

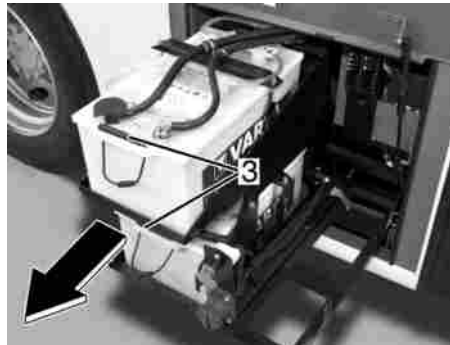

M54_00-0691-01

- ▶ Pull the batteries out on the support frame by gripping handles (3) with both hands.

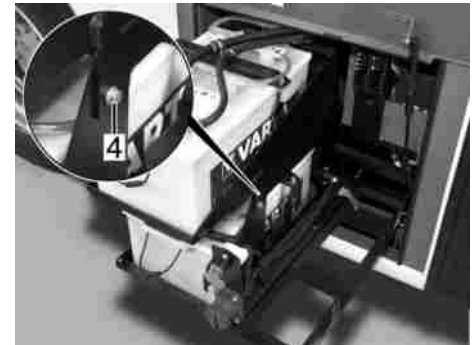

M54_00-0690-01

- ▶ Unscrew retaining screw (4) on the upper battery carrier.

Jump-starting where vehicle batteries are mounted one above the other



M54_00-0687-01

- ▶ Swing the upper battery carrier to the right.

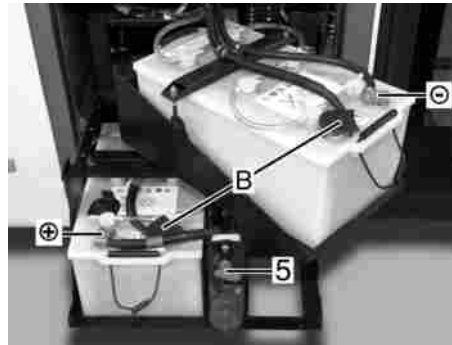

M54_00-0689-01

- ▶ Connect one end of the positive cable to the (+) terminal of the discharged battery first, then connect the other end of the positive cable to the (+) terminal of the donor battery.



Danger.

Risk of injury/explosion. Do not connect the jump lead to the battery terminals (B) to which the connecting cable between battery 1 and battery 2 is connected.

- ▶ Connect the negative cable to the (-) terminal on the donor battery and then the other end to an earthed, bare metal part connected to the skeleton of the bus being jump-started.



Note:

Make the connection as far as possible from the discharged battery.

- ▶ Run the engine of the donor vehicle at an elevated idling speed.
- ▶ Start the engine of the bus to be jump-started in the normal way and let it run at idling speed.
- ▶ Switch off the engine of the donor vehicle.

Jump-starting where vehicle batteries are mounted side by side

- ▶ Fully disconnect the negative/earth connection of the jump leads and then disconnect the positive cable.



Note:

To prevent voltage peaks, switch on the more powerful consumers of the jump-started bus, such as the lighting, heated windows or ventilation, before you disconnect the jump leads.

Jump-starting where vehicle batteries are mounted side by side



Danger.

Risk of accident. Secure the bus against rolling away.

- ▶ Turn the key in the ignition starter switch back to the stop (position “0”).



M54_00-0531-01

- ▶ Open the service cover on battery compartment (1).

Jump-starting where vehicle batteries are mounted side by side



M54_00-0684-01

- ▶ Pull out spring pin (2) on the battery support frame.

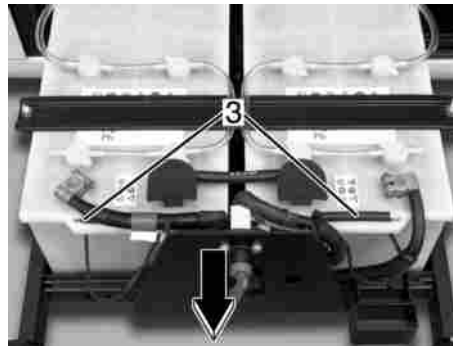

M54_00-0685-01

- ▶ Pull the batteries out on the support frame by gripping handles (3) with both hands.
- ▶ Connect one end of the positive cable to the (+) terminal of the discharged battery first, then connect the other end of the positive cable to the (+) terminal of the donor battery.

- ▶ Connect the negative cable to the (-) terminal on the donor battery and then the other end to an earthed, bare metal part connected to the skeleton of the bus being jump-started.



Note:

Make the connection as far as possible from the discharged battery.

- ▶ Run the engine of the donor vehicle at an elevated idling speed.
- ▶ Start the engine of the bus to be jump-started in the normal way and let it run at idling speed.
- ▶ Switch off the engine of the donor vehicle.

Jump-starting buses equipped with a battery charging socket

- ▶ Fully disconnect the negative/earth connection of the jump leads and then disconnect the positive cable.



Note:

To prevent voltage peaks, switch on the more powerful consumers of the jump-started bus, such as the lighting, heated windows or ventilation, before you disconnect the jump leads.

Jump-starting buses equipped with a battery charging socket



Danger.

Risk of accident. Secure the bus against rolling away.

- ▶ Turn the key in the ignition starter switch back to the stop (position "0").



M54_00-0531-01

- ▶ Open the service cover on battery compartment (1).

Jump-starting buses equipped with a battery charging socket

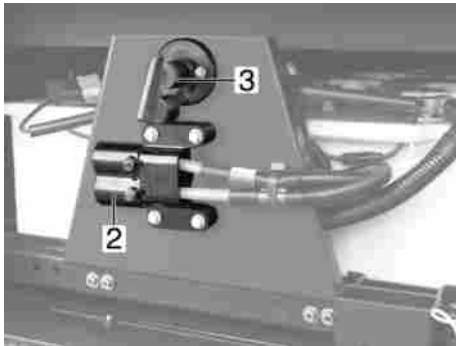

M54_00-0693-01

- ▶ Connect a suitable jump lead to battery charging socket (2).



Note:

Example illustrated: manufactured by Fenwick

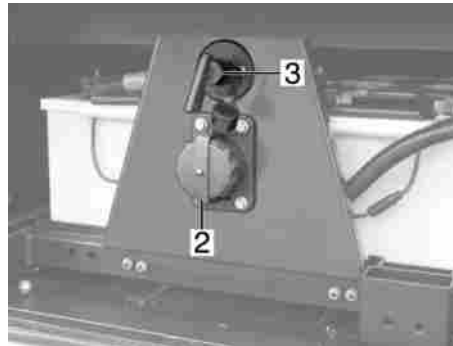

M54_00-0694-01

- ▶ Connect a suitable jump lead to battery charging socket (2).



Note:

Example illustrated: Nato socket

- ▶ Run the engine of the donor vehicle at an elevated idling speed.
- ▶ Start the engine of the bus to be jump-started in the normal way and let it run at idling speed.

- ▶ Switch off the engine of the donor vehicle.
- ▶ Disconnect the jump lead.



Note:

To prevent voltage peaks, switch on the more powerful consumers of the jump-started bus, such as the lighting, heated windows or ventilation, before you disconnect the jump lead.

Opening the emergency exit in the roof

Opening the emergency exit in the roof



M77_00-0001-01

- ▶ Press in security foil (1).

Behind the security foil is a handle.

Roof plate (2) can be removed using handle (3).

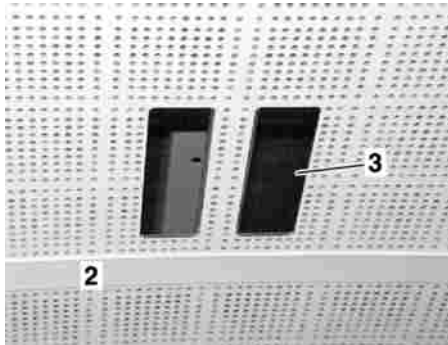

M77_00-0002-01

- ▶ Remove roof plate (2) using handle (3).



Danger.

Risk of accident. Only remove the roof plate or operate the emergency exit in an emergency and with the bus stationary.



M77_00-0014-01

- ▶ The emergency operation is triggered using a red rotary handle on the inside or outside (1).



Note:

In emergencies, the twistgrip on the inside (1) must be turned in the direction of the arrow (clockwise). The emergency exit cover can now be secured by a safety rope and placed to one side outside the bus.

Folding out and folding in headlamps or bumper corner pieces



Danger.

The cover for the roof emergency exit hatch must be fitted by skilled personnel at an EvoBus Service Partner following the emergency operation.

- ▶ On an articulated bus, an emergency hammer is located in the roof of the rear car underneath the emergency exit cover. In an emergency, the hammer can be used to break the glass panel in the emergency exit.



Danger.

Risk of injury. There is a risk of injury from flying glass splinters when smashing the window with the emergency hammer. Protect your hands and eyes.



Danger.

Risk of injury. There is a risk of cutting yourself. Take care when leaving the vehicle through a smashed window.

Folding out and folding in headlamps or bumper corner pieces



Note:

Preconditions: bus secured against moving off of its own accord, front flap open.



Danger.

The bus must not be moved if a bumper corner piece has been unlocked or folded out.

Folding out and folding in headlamps or bumper corner pieces



M88_20-0001-01

- ▶ Move the lever (arrowed) on the rear of the flap lock to the left.



Note:

The direction of movement “to the left” (when viewed in the direction of travel) applies to both bumper corner pieces.



Note:

The bumper corner piece is additionally secured by a quick-release lock.

- ▶ Grasp the bumper corner piece above the headlamp and pull it in the direction of the arrow against the resistance of the quick-release lock.



Note:

The direction of the arrow signifies: forwards and diagonally away from the centre of the vehicle.



Note:

The fold angle is limited to approximately 60° by a retention strap.

- ▶ To fold the bumper corner piece in, lift it up and push it against the flap lock.



Caution:

Before the bumper corner piece is folded in, make sure that the closing tongue in the quick-release lock is correctly positioned and correct if necessary.



Danger.

Risk of accident if the bumper corner piece folds out of its own accord. Both the quick-release lock and the flap lock must be heard or felt to lock into place. If necessary, check that the flap lock is correctly seated by gently pulling or joggling the bumper corner piece in the same direction as when folding it out.

Note on maintenance work

Note on maintenance work



Note:

All the maintenance work is described in special instructions. The tasks listed here are not subject to any maintenance interval in particular, rather they should be carried out as frequently as appropriate given the conditions of vehicle use.

Cleaning the underbody



Note:

The underbody refers to the entire underbody of the bus, including the bus floor, the wheel housings and the underbody carcass.



Note:

The underbody should be inspected at regular intervals and cleaned according to the level of dirt, but at least once a year in conjunction with the annual maintenance service. This enables underbody protection coating which is flawed or damaged to be identified and remedied in good time.

Cleaning the underbody with a hot-water high-pressure cleaner



Note:

Remove the protective cladding on the underbody and clean it separately.



Note:

The underbody is protected by protective coatings against corrosion and stones being thrown up. Clean as carefully as possible to avoid washing off or damaging the good protective layers. Match the water temperature and pressure to the spray nozzle and spraying distance appropriately.



Note:

The underbody should be washed primarily using clean water. Only use a cleaning product on dirt which is very difficult to remove.

Cleaning the underbody



Environmental protection

Observe waste water guidelines. Only clean the bus in an area appropriately equipped for cleaning.

- ▶ Inspect the underbody and pay attention to damage and an unusually heavily impregnated and discoloured dirt layer.



Note:

It will be possible to detect faults on the dirty underbody which will no longer be visible after cleaning. For example, leaking unions on oil, fuel and coolant pipes and reservoirs, leaking points on assemblies, hidden corrosion in the stained layers of dirt may be detected. Remedy any faults and damage remaining after cleaning.

- ▶ Use a hot-water high-pressure cleaner in accordance with the manufacturer's instructions.

Organisational resource

Hot-water high-pressure cleaner

Alfred Kärcher GmbH & Co.

Wap-Reinigungssysteme GmbH & Co



Danger.

Risk of injury due to improper use of the high-pressure cleaner and damaged accessories. Observe the manufacturer's operating instructions, comply with safety notes and wear protective clothing.

- ▶ Mix cleaning products with the washing water if necessary according to the manufacturer's instructions or in the concentration given on the container intended for use on the unit.

Repair agent

RM 55 XXL

Alfred Kärcher Vertriebs GmbH,

www.kaercher.de, tel.: +49(0) 71 95-90 30

Repair agent

P3-grato 80

Henkel KGaA, www.henkel.de,

Repair agent

HAKAPUR 50-268

CHEMISCHE WERKE KLUTHE GmbH,
www.kluthe.com, tel.: +49 (0)6221/
5301-0



Danger.

Risk of injury from corrosive components in the cleaning products. Follow the manufacturer's safety instructions.



Caution:

Only use recommended cleaning products. Unsuitable cleaning products could damage the bus. Highly concentrated cleaning products must be diluted according to the manufacturer's instructions.

- ▶ Fit the spray lance with a flat-spray jet or use a variable adjustable nozzle to set the spray angle.

Setting values

Designation	Value
Spray angle of the flat jet nozzle at least	25°



Caution:

Round-spray jets and power-concentrated jets must not be used. The effect of the water jet on these tools is too aggressive for cleaning the bus and could cause serious damage to the bus.



Note:

The nozzle spraying angle determines the level of cleaning. The greater the nozzle spraying angle, the more protection offered when cleaning.

- ▶ Set the water pressure, water temperature and the concentration of the cleaning product on the high-pressure cleaner.

Setting values

Designation	Value
Maximum permissible water pressure	60 bar

Setting values

Designation	Value
Maximum permissible water temperature	60 °C



Caution:

The protective coating on the underbody or components may be damaged if the water pressure and/or water temperature are too high or a wrong spray nozzle is fitted.



Caution:

The addition and concentration of the cleaning products should be adjusted according to the type and level of dirt on the area to be cleaned. Excess cleaning product can cause damage.

- ▶ Turn on the water jet pointing it towards the ground or open-air and then move it onto the surface to be cleaned. Maintain the maximum permitted jet distance.

Setting values

Designation	Value
Spray distance from the object at least	30 cm

Cleaning the underbody



Danger.

Risk of injury from hot water. The spray lance could rebound if the jet hits the surface to be cleaned directly from a short distance.



Danger.

Risk of injury from high pressure and hot water. Do not direct the spray lance at animals or people.

- ▶ Spray the layer of dirt on the underbody thoroughly with the water jet.



Note:

Let the sprayed water take effect. You may need to spray several times, depending on the level of dirt.



Note:

Pay particular attention to dirt deposits in corners, cavities, wheel housings and on lines, as well as between the ramp and underbody.

- ▶ Rinse the layer of dirt on the underbody with a high-pressure water jet.



Danger.

Do not direct high-pressure jets directly on to tyres, suspension air bags or brake hoses, special hose connections made of rubber, gaiters and mountings of moving parts, electrical lines, components and their connections. Move the high-pressure jet continually and change the direction at which it hits the surface to be cleaned.



Note:

Only direct the high-pressure jet at seams, gaps or cavities for brief periods. Water penetrating deep into the bus, enhanced by the cleaning product, could lead to hidden corrosion and weaken supporting components of the carcass.

- ▶ Stop using the cleaning product and rinse the entire underbody area with water.



Note:

Cleaning products should not be allowed to dry on. Cleaning agent residues may permanently damage surfaces and especially movable parts.

- ▶ Clean openings and drainage holes for condensate in pipes, sections and cavities by hand, e.g. with a pen.



Note:

Do not wash out drainage openings using a pressure cleaner. The openings guarantee that any water or condensation which has penetrated during cleaning can drain out or dry.

- ▶ Let the underbody dry.



Caution:

Do not blow away any remaining moisture using compressed air.

- ▶ Finally, carry out a visual inspection of the underbody.



Note:

During the visual inspection, look in particular for complete and undamaged protective coating (wax and stone impact protection) and corrosion damage. Also check for damage to tyres, suspension air bags, brake hoses, sealing gaiters and bearings for moving parts, as well as electrical lines and their connections.



Note:

Repair established faults or damage properly and lubricate mountings and joints. Replace damaged tyres, suspension air bags and pressure hoses.

- ▶ Carry out a test run with a braking test and observe the operation of the level control.



Note:

Have any faults remedied professionally.

Vehicle data **278**

Vehicle data

Vehicle data	
Designation	Value
Vehicle length	CITARO K: 10,503 mm
Bumper-to-bumper length	CITARO: 11,950 mm CITARO M: 13,008 mm CITARO L: 14,995 mm CITARO G: 17,940 mm CapaCity: 19,540 mm
Vehicle width	2,550 mm
Production version	
Vehicle height without roof-mounted fittings	2,871 mm

Designation	Value
Vehicle height with roof-mounted fittings fitted as standard	3,009 mm
Vehicle height with air conditioning system	3,076 mm CapaCity: 3,155 mm
Permissible gross vehicle weight	CITARO K: 18,000 kg CITARO: 18,000 kg CITARO M: 18,000 kg CITARO L: 26,000 kg CITARO G: 28,000 kg CapaCity: 32,000 kg
Permissible gross ski holder load	CITARO K: max. 500 kg

Designation	Value
Track width, front axle	2,113 mm
Track width, centre axle (CITARO G/ CapaCity)	1,834 mm
Track width, driven axle	1,834 mm
Track width, trailing axle (CITARO L/ CapaCity)	2,055 mm

Designation	Value
Wheel base 1st to 2nd axle	CITARO K: 4,398 mm
	CITARO: 5,845 mm
	CITARO M: 6,862 mm
	CITARO L: 7,290 mm
	CITARO G/ CapaCity: 5,845 mm
	Wheel base 2nd to 3rd axle
	CITARO G/ CapaCity: 5,990 mm
Wheel base 3rd to 4th axle	CapaCity: 1,600 mm

Designation	Value
Turning circle (k to k)	CITARO K: 13,132 mm
	CITARO: 16,846 mm
	CITARO M: 19,576 mm
	CITARO L: 19,702 mm
	CITARO G: 19,002 mm
	CapaCity: 19,088 mm

Designation	Value
Turning circle (w to w)	CITARO K: 17,244 mm
	CITARO: 21,030 mm
	CITARO M: 23,700 mm
	CITARO L: 24,324 mm
	CITARO G: 22,850 mm
	CapaCity: 22,852 mm
Front overhang	2,705 mm

Vehicle data

Designation	Value
Rear overhang	CITARO K: 3,400 mm CITARO: 3,400 mm CITARO M: 3,441 mm CITARO L: 3,400 mm CITARO G: 3,400 mm CapaCity: 3,400 mm
Angle of approach	7°
Angle of departure	7°
Pitch angle (CITARO G/CapaCity)	-10° ... 10°

Designation	Value
Total fuel tank volume	CITARO K: approx. 280 l CITARO: approx. 280 l CITARO M: approx. 350 l CITARO L: approx. 280 l CITARO G/ CapaCity: approx. 300 l
AdBlue additive tank volume	CITARO K: approx. 38 l CITARO: approx. 38 l CITARO M: approx. 46 l CITARO L: approx. 38 l CITARO G/ CapaCity: approx. 45 l

Designation	Value
Fuel-oil tank capacity (option) (on request, the CITARO K can be fitted with an auxiliary tank in place of the fuel-oil tank)	CITARO K: approx. 35 l CITARO: approx. 50 l CITARO M: approx. 50 l CITARO L: approx. 50 l CITARO G/ CapaCity: approx. 50 l
Windscreen washer reservoir	approx. 8 l

- A**
- Acceleration skid control (ASR)**
 activating/deactivating 33
- Accident data recorder (ADR)**
 Operation 52-53
- AdBlue**
 Service product 40
- Air-conditioning system**
 Operating instructions 179
 Safety precautions 179
- Anti-jackknifing protection**
 during forward travel 54
 during reverse travel 54
- Automatic transmission**
 General 170
 Selector positions of the 3-
 pushbutton switch panel ... 171-172
 Selector positions of the 6-
 pushbutton switch panel ... 173-175
- Auxiliary heating**
 Safety precautions 10
- B**
- Batteries**
 Care 256
- Recharging 256
 Safety precautions 255
- BlueTec exhaust gas cleaning system** 47-48
- Brake pressure/supply pressure** . 30
- Brakes with anti-locking protection** 29
- Braking and stopping** 29
- Bus stop brake**
 Activating/deactivating 155
- C**
- Care and cleaning**
 Cleaning the underbody ... 271-275
 Covers and upholstery 70
 Fabric covers 70
 Safety precautions 66
 Tilting the rear seats 67
- Continuous braking**
 activating 105
- Cruise control**
 activating 104
- D**
- Departure check**
 Daily tasks 12
- Weekly tasks 13
- Doors**
 Emergency operation 210-211
 Forced door closure in an
 emergency 212-213
 Locking door 1 with the key
 (option) 216
 Locking/unlocking the door
 leaves from the outside 214
 Opening/closing automatic
 doors - code T51 223-224
 Opening/closing automatic
 doors from the inside 219-220
 Opening/closing automatic
 doors from the outside 221-222
 Opening/closing door 1 from
 the outside 214-215
 Opening/closing door 1 from the
 outside - code WV1 216
 Opening/closing the doors from
 the inside 218
 Protection against entrapment in
 the door closing direction 209
 Protection against entrapment in
 the door opening direction ... 209

- Switching between automatic and manual door operation . 225-226
 - Teaching in the doors in the closing and opening directions 227-230
 - Drive-off lock** 156
 - Emergency release 252
 - Driver's area**
 - Overview 78
 - Side panel 84-87
 - Driver's seat**
 - Grammer MSG 90.5 166-167
 - Driver's window**
 - opening/closing 159
 - Driving** 21-22
- E**
- Electric cassette ramp**
 - Retracting/extending the electric ramp 63-65
 - Electrical system** 257
 - Measures required for the prevention of damage 258
 - Safety precautions 254
 - Switching off the on-board power supply at the master safety switch 260
 - Switching the on-board power supply on/off 259
 - Emergency equipment** 96
 - Engine**
 - Starting 19-20
 - Stopping 23
 - Engine oil level display** 236-238
- F**
- Fire extinguishing system**
 - Red warning level 72-73
 - Yellow warning level 71
 - Folding out and folding in headlamps or bumper corner pieces** 269-270
- H**
- Heating, ventilation and air-conditioning system**
 - Additional driver's area ventilation (option) 187
 - Driver's area - adjusting the blower speed 185
 - Driver's area - adjusting the temperature 184
 - Driver's area - cooling 186
 - Driver's area - setting the air distribution/demisting the windscreen 183
 - Fans on/off 199
 - Passenger compartment - switching automatic temperature regulation on and off 189
 - Passenger compartment - switching automatic temperature regulation on and off - code HH2/HK1 188
 - Passenger-compartment temperature - changing the base value 193-195
 - Switching air-recirculation mode on and off 187
 - Switching fans on and off - code HH2/HK1 200-201
 - Switching the auxiliary heating on and off 190-191
 - Switching the reheat function on and off 192

Heating/ventilation/air-conditioning

- Driver's area control panel 88, 180-181
- Passenger compartment control panel 182

I

- Identification plate** 1-3
- Ignition switch** 79, 107
- Instrument cluster** 88-91

J**Jacking points**

- Centre (articulated buses only) 250
- Front 250
- General information 248-249
- Rear 251

Jump-starting

- Buses equipped with a battery charging socket 266-267
- Where vehicle batteries are mounted one above the other 261-263
- Where vehicle batteries are mounted side by side 264-265

M**Malfunction displays**

- Red warning level - overview 126-127
- Warning level C - overview 136
- Yellow warning level A - overview 130-131
- Yellow warning level B - overview 134

Master safety switch

- (emergency-off switch)** 109

Mechanical cassette ramp

- Pulling out/sliding in the mechanical cassette ramp 60-62

Mirror and window heating

- switching on/off 160

N

- Note symbols** 6

O

- Opening the emergency exit in the roof** 268

- Opening the hinged window** 66

Operating/malfunction displays

- ABS/ASR 34
- Brake system 31-32
- Fuel system 50-51

P**Parking brake**

- Applying 152
- Emergency release (option) 253
- General 108
- Releasing 153

Pull-away aid

- Activating/deactivating 147

- Pushchair stop request** 231-232

R**Raising/lowering system**

- Lowering/raising the bus on the entry side 143-144
- Raising the bus above normal level 145-146

Ramp

- folding in/out 58-59

- Ramp request** 56

Refuelling

- AdBlue 49
- Diesel fuel 37-38
- Opening/closing the fuel filler cap 45-46

Retarder

- Direct 36
- Disabling activation by brake pedal (option) 35

Roof hatches 196-198

Rotary light switch 81, 102

Running-in guideline 19

S**Screen**

- Calling up/selecting/permanently displaying operating displays ... 137
- Description 111
- Display types 112-120
- Fuel consumption indicator (option) 140-141
- Malfunction displays 124
- Malfunction displays: red warning level 125
- Malfunction displays: warning level C 135
- Malfunction displays: yellow warning level A 128-129
- Malfunction displays: yellow warning level B 132

Selecting the language 138-139

Seat belt

Driver's seat 168

Skibox (option)

Fitting 68-69

Snow chains 243-244

Steering column switch

for light and wiper functions 79

for retarder and cruise

control 79, 104-106

Light and signal functions 103

Wiper and wash functions 103

Stop request 55

T**Tachograph**

Display 95

DTCO 79, 94

MTCO 79, 92-93

Towing 23, 26

Towing 24-25

Towing coupling

Front 26-27

Rear 28

Track guidance 151

Trailing axle

Manual centring 148

Activating/deactivating the automatic steering limiter (bus stop function) 149-150

Tyres

Cleaning the tyres 242

Flat tyre 248

Invisible tyre damage 241

Operating safety and roadworthiness 239

Retreaded tyres 242

Tyre age 240

Tyre condition 240

Tyre load capacity, top speed of tyres and types of tyres 241

Tyre pressure 239

Tyre pressures table 246-247

Tyre tread 240

Tyres/wheels

Retightening the wheel nuts ... 242

Wheel nut tightening torques ... 243

V

Vehicle data 278-280

Vehicle key

Overview 76-77

W**Warning and indicator lamps**

Overview 110

Windscreen heating (option)

activating/deactivating 161-162

Winter operation 41